

128Mb L-die DDR SDRAM Specification

66 TSOP-II
with Lead-Free and Halogen-Free
(RoHS compliant)

INFORMATION IN THIS DOCUMENT IS PROVIDED IN RELATION TO SAMSUNG PRODUCTS, AND IS SUBJECT TO CHANGE WITHOUT NOTICE. NOTHING IN THIS DOCUMENT SHALL BE CONSTRUED AS GRANTING ANY LICENSE, EXPRESS OR IMPLIED, BY ESTOPPEL OR OTHERWISE, TO ANY INTELLECTUAL PROPERTY RIGHTS IN SAMSUNG PRODUCTS OR TECHNOLOGY. ALL INFORMATION IN THIS DOCUMENT IS PROVIDED ON AS "AS IS" BASIS WITHOUT GUARANTEE OR WARRANTY OF ANY KIND.

1. For updates or additional information about Samsung products, contact your nearest Samsung office.
2. Samsung products are not intended for use in life support, critical care, medical, safety equipment, or similar applications where Product failure could result in loss of life or personal or physical harm, or any military or

* Samsung Electronics reserves the right to change products or specification without notice.

Table of Contents

1.0 Key Features	4
2.0 Ordering Information	4
3.0 Operating Frequencies	4
4.0 Pin / Ball Description	5
5.0 Package Physical Dimension	7
6.0 Block Diagram (2Mb x 16 I/O x4 Banks)	9
7.0 FUNCTIONAL DESCRIPTION	10
7.1 Power-up & Initialization Sequence	10
7.2 Mode Register Definition	11
7.3 Extended Mode Register Set(EMRS)	13
8.0 Input/Output Function Description	14
9.0 Command Truth Table	15
10.0 General Description	16
11.0 Absolute Maximum Rating	16
12.0 DC Operating Conditions	16
13.0 DDR SDRAM Spec Items & Test Conditions	17
14.0 Input/Output Capacitance	17
15.0 Detailed test condition for DDR SDRAM IDD1 & IDD7A	18
16.0 DDR SDRAM IDD spec table	19
17.0 AC Operating Conditions	20
18.0 AC Overshoot/Undershoot specification for Address and Control Pins	20
19.0 Overshoot/Undershoot specification for Data, Strobe and Mask Pins	21
20.0 AC Timing Parameters & Specifications	22
21.0 System Characteristics for DDR SDRAM	23
22.0 Component Notes	24
23.0 System Notes	26
24.0 IBIS : I/V Characteristics for Input and Output Buffers	27

Revision History

Revision	Month	Year	History
1.0	September	2008	- Release rev.1.0 SPEC - Corrected max tCK complying JEDEC
1.1	October	2008	- Changed tCK max of 400/333Mbps to 10ns from 12ns - Corrected IDD1 current measurement condition
1.2	February	2009	- Added FBGA package SPEC - Corrected matched drive strength SPEC.

1.0 Key Features

- V_{DD} : 2.5V \pm 0.2V, V_{DDQ} : 2.5V \pm 0.2V for DDR333, 400
- V_{DD} : 2.5V \pm 5%, V_{DDQ} : 2.5V \pm 5% for DDR500
- Double-data-rate architecture; two data transfers per clock cycle
- Bidirectional data strobe [L(U)DQS] (x16)
- Four banks operation
- Differential clock inputs(CK and \overline{CK})
- DLL aligns DQ and DQS transition with CK transition
- MRS cycle with address key programs
 - Read latency : DDR333(2.5 Clock), DDR400(3 Clock), DDR500(3 Clock)
 - Burst length (2, 4, 8)
 - Burst type (sequential & interleave)
- All inputs except data & DM are sampled at the positive going edge of the system clock(CK)
- Data I/O transactions on both edges of data strobe
- Edge aligned data output, center aligned data input
- LDM,UDM for write masking only (x16)
- Auto & Self refresh
- [15.6us refresh interval\(4K/64ms refresh\)](#)
- Maximum burst refresh cycle : 8
- 66pin TSOP II **Lead-Free and Halogen-Free** package
- **RoHS compliant**

2.0 Ordering Information

Part No.	Org.	Max Freq.	Interface	Package	Note
K4H281638L-LCCD	8M x 16	CD(DDR500@CL=3)	SSTL2	66pin TSOP II Lead-Free & Halogen-Free	
K4H281638L-LCCC		CC(DDR400@CL=3)			
K4H281638L-LCB3		B3(DDR333@CL=2.5)			

3.0 Operating Frequencies

	CD(DDR500@CL=3)	CC(DDR400@CL=3)	B3(DDR333@CL=2.5)
Speed @CL2	N/A	N/A	N/A
Speed @CL2.5	166MHz	166MHz	166MHz
Speed @CL3	250MHz	200MHz	-
CL-tRCD-tRP	3-4-4	3-3-3	2.5-3-3

4.0 Pin / Ball Description

66pin TSOP - II

8Mb x 16

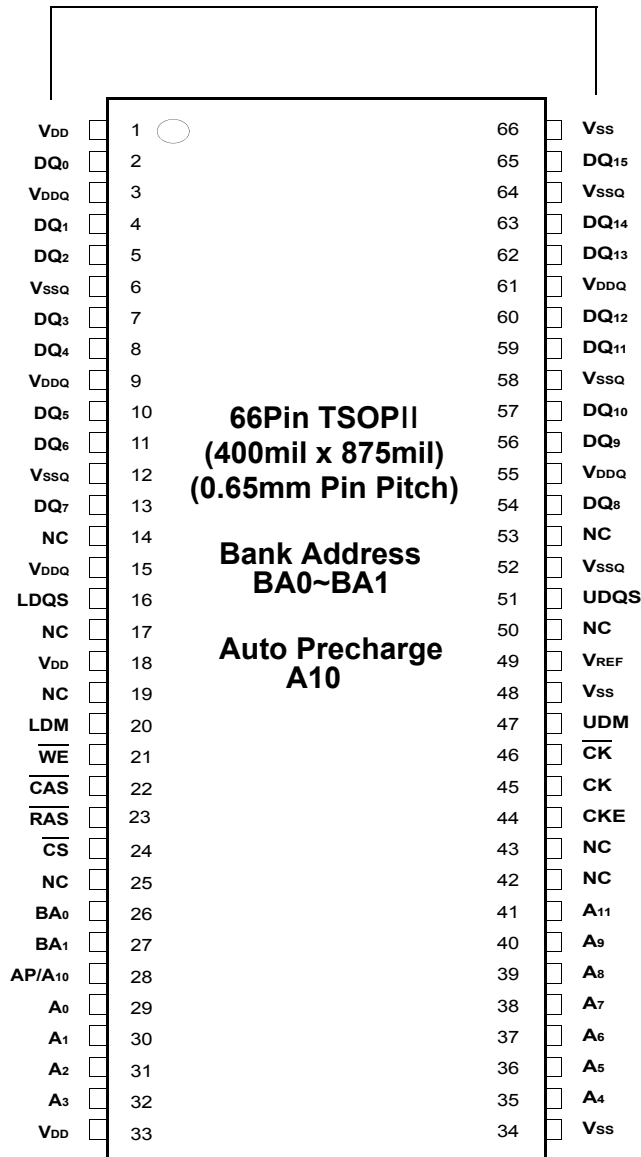

128Mb TSOP-II Package Pinout

Organization	Row Address	Column Address
8Mx16	A0~A11	A0-A8

DM is internally loaded to match DQ and DQS identically.

Row & Column address configuration

60ball FBGA (Top View)

4M x 16

9	V _{DDQ}	DQ1	DQ3	DQ5	DQ7	NC						
8	DQ0	V _{SSQ}	V _{DDQ}	V _{SSQ}	V _{DDQ}	V _{DD}	$\overline{\text{CAS}}$	$\overline{\text{CS}}$	BA0	A10/AP	A1	A3
7	V _{DD}	DQ2	DQ4	DQ6	LDQS	LDM	$\overline{\text{WE}}$	$\overline{\text{RAS}}$	BA1	A0	A2	V _{DD}
	A	B	C	D	E	F	G	H	J	K	L	M
3	V _{SS}	DQ13	DQ11	DQ9	UDQS	UDM	$\overline{\text{CK}}$	CKE	A9	A7	A5	V _{SS}
2	DQ15	V _{DDQ}	V _{SSQ}	V _{DDQ}	V _{SSQ}	V _{SS}	CK	NC	A11	A8	A6	A4
1	V _{SSQ}	DQ14	DQ12	DQ10	DQ8	V _{REF}						

64Mb FBGA Package ballout

Organization	Row Address	Column Address
4Mx16	A0~A11	A0-A7

DM is internally loaded to match DQ and DQS identically.

Row & Column address configuration

5.0 Package Physical Dimension

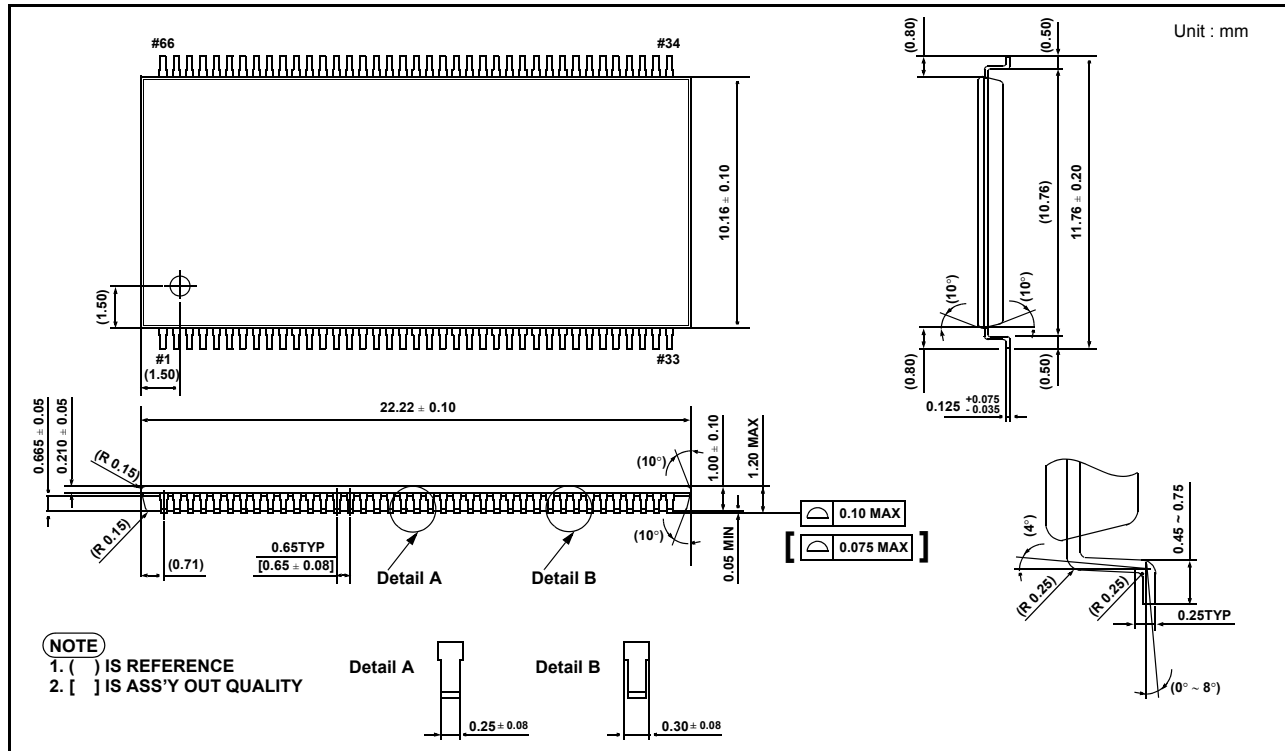

66Pin TSOP(II) Package Dimension

Units : Millimeters

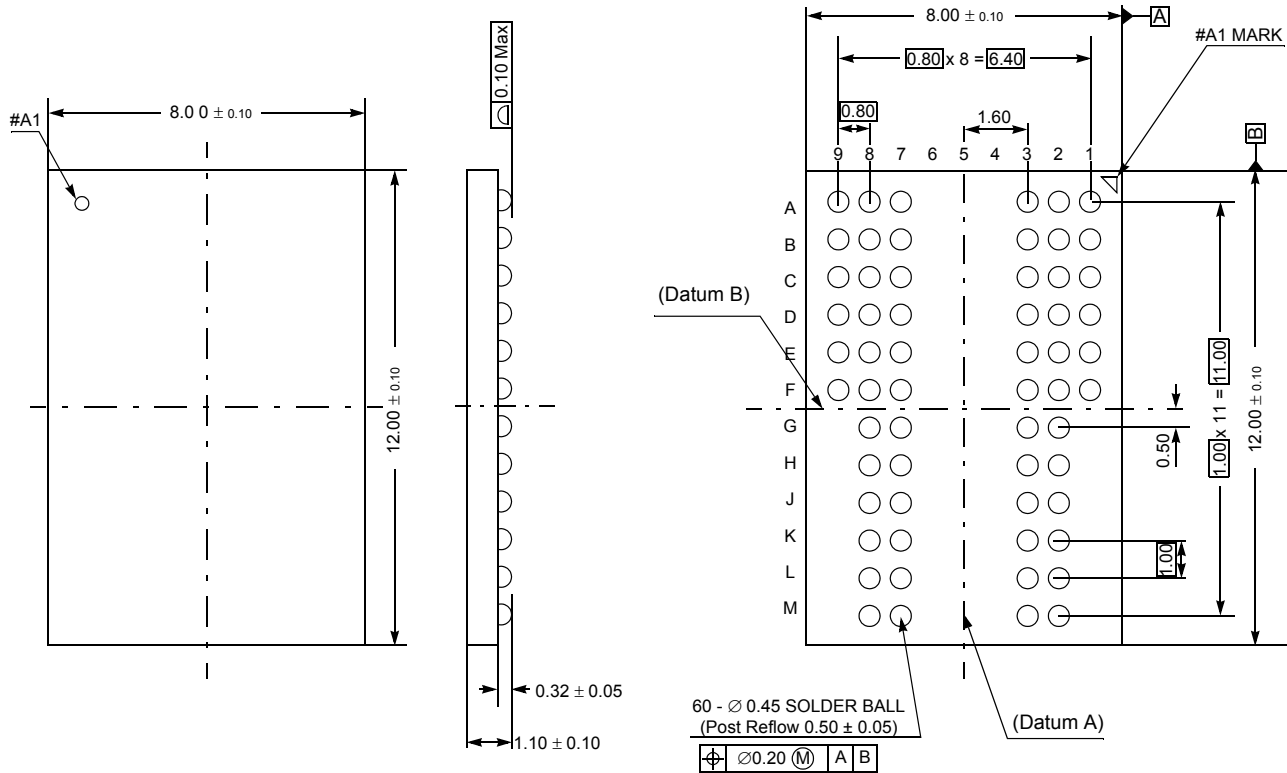

TOP VIEW

BOTTOM VIEW

60Ball FBGA 64Mb Package Dimension

6.0 Block Diagram (2Mb x 16 I/O x 4 Banks)

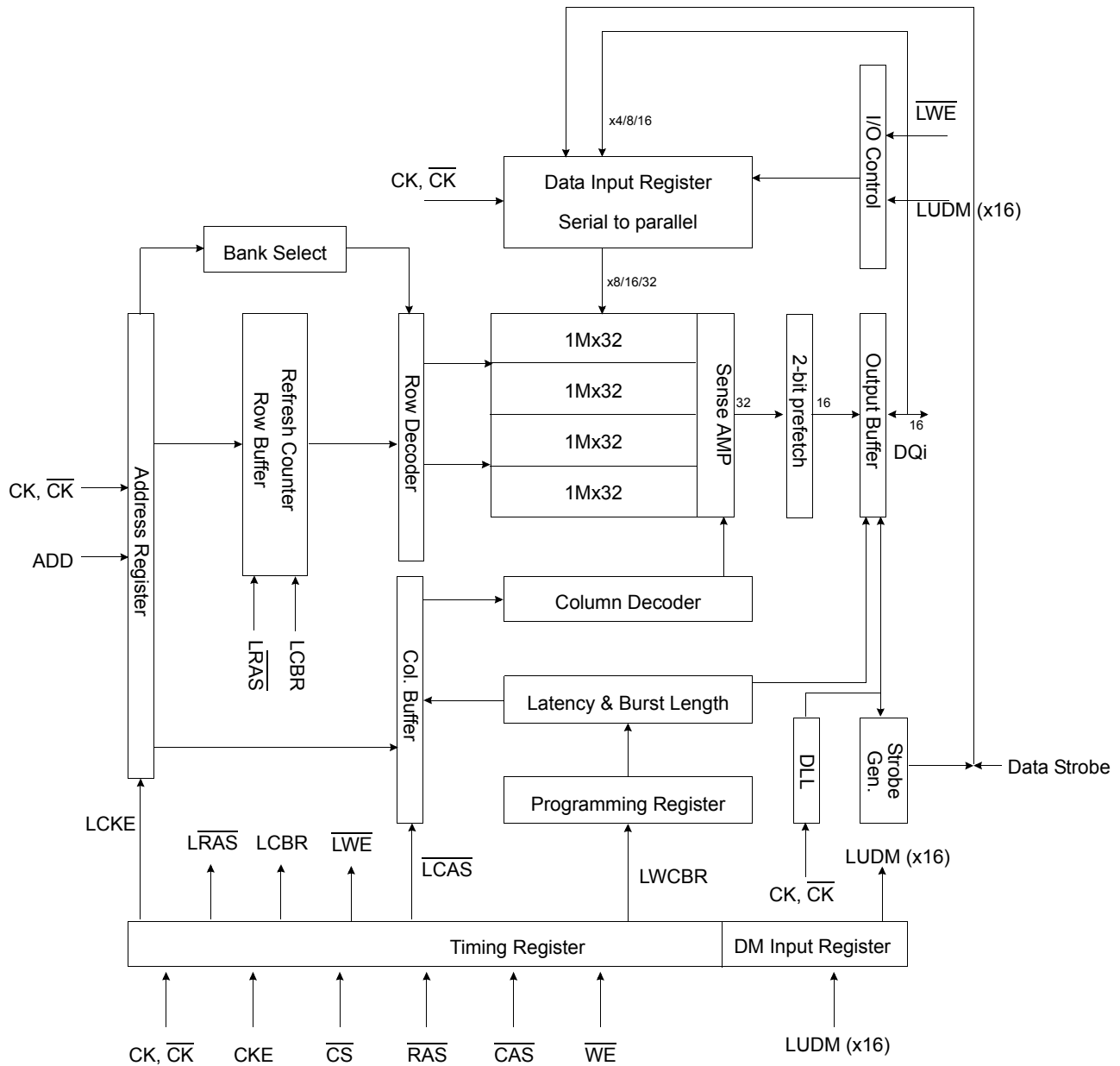

7.0 FUNCTIONAL DESCRIPTION

7.1 Power-up & Initialization Sequence

DDR SDRAMs must be powered up and initialized in a predefined manner. Operational procedures other than those specified may result in undefined operation. No power sequencing is specified during power up and power down given the following

- V_{DD} and V_{DDQ} are driven from a single power converter output, AND
- V_{TT} is limited to 1.35 V, AND
- V_{REF} tracks $V_{DDQ}/2$ OR, the following relationships must be followed:
- V_{DDQ} is driven after or with V_{DD} such that
- $V_{DDQ} < V_{DD} + 0.3$ V AND
- V_{TT} is driven after or with V_{DDQ} such that $V_{TT} < V_{DDQ} + 0.3$ V, AND
- V_{REF} is driven after or with V_{DDQ} such that $V_{REF} < V_{DDQ} + 0.3$ V.

At least one of these two conditions must be met.

Except for CKE, inputs are not recognized as valid until after V_{REF} is applied. CKE is an SSTL_2 input, but will detect an LVCMOS LOW level after V_{DD} is applied. Maintaining an LVCMOS LOW level on CKE during power up is required to guarantee that the DQ and DQS outputs will be in the High-Z state, where they will remain until driven in normal operation (by a read access). After all power supply and reference voltages are stable, and the clock is stable, the DDR SDRAM requires a 200 μ s delay prior to applying an executable command. Once the 200 μ s delay has been satisfied, a DESELECT or NOP command should be applied, and CKE should be brought HIGH. Following the NOP command, a PRECHARGE ALL command should be applied. Next a MODE REGISTER SET command should be issued for the Extended Mode Register, to enable the DLL, then a MODE REGISTER SET command should be issued for the Mode Register, to reset the DLL, and to program the operating parameters. 200 clock cycles are required between the DLL reset and any read command. A PRECHARGE ALL command should be applied, placing the device in the "all banks idle" state.

Once in the idle state, two AUTO refresh cycles must be performed. Additionally, a MODE REGISTER SET command for the Mode Register, with the reset DLL bit deactivated (i.e., to program operating parameters without resetting the DLL) must be performed. Following these cycles, the DDR SDRAM is ready for normal operation.

7.2 Mode Register Definition

Mode Register Set(MRS)

The mode register stores the data for controlling the various operating modes of DDR SDRAM. It programs $\overline{\text{CAS}}$ latency, addressing mode, burst length, test mode, DLL reset and various vendor specific options to make DDR SDRAM useful for variety of different applications. The default value of the mode register is not defined, therefore the mode register must be written after EMRS setting for proper DDR SDRAM operation. The mode register is written by asserting low on $\overline{\text{CS}}$, $\overline{\text{RAS}}$, $\overline{\text{CAS}}$, $\overline{\text{WE}}$ and BA0(The DDR SDRAM should be in all bank precharge with CKE already high prior to writing into the mode register). The states of address pins A0 ~ A11 in the same cycle as $\overline{\text{CS}}$, $\overline{\text{RAS}}$, $\overline{\text{CAS}}$, $\overline{\text{WE}}$ and BA0 going low are written in the mode register. Two clock cycles are requested to complete the write operation in the mode register. The mode register contents can be changed using the same command and clock cycle requirements during operation as long as all banks are in the idle state. The mode register is divided into various fields depending on functionality. The burst length uses A0 ~ A2, addressing mode uses A3, $\overline{\text{CAS}}$ latency(read latency from column address) uses A4 ~ A6. A7 is used for test mode. A8 is used for DLL reset. A7 must be set to low for normal MRS operation. Refer to the table for specific codes for various burst lengths, addressing modes and CAS latencies.

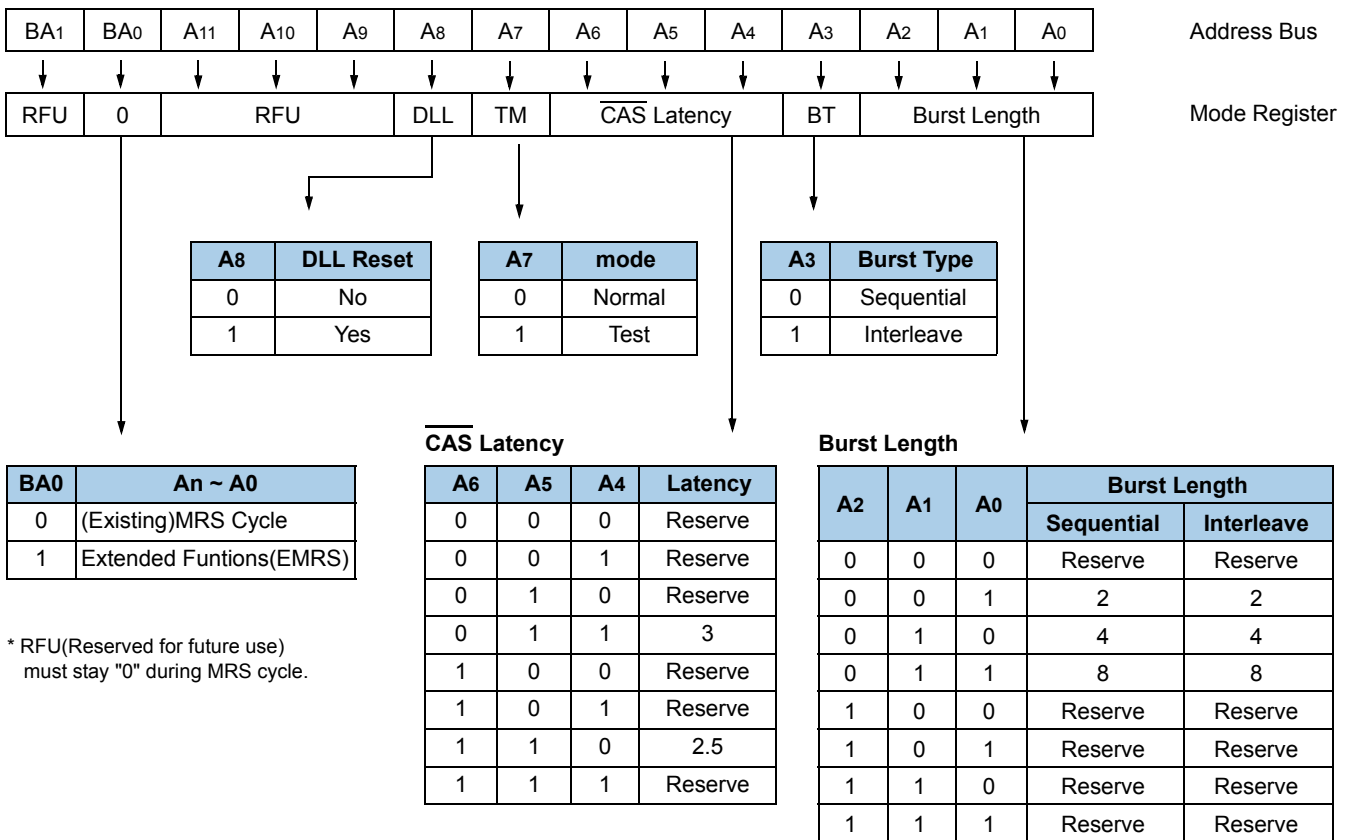

* RFU(Reserved for future use) must stay "0" during MRS cycle.

Note : *1 A12 is used for 256Mb only. That is 128Mb uses A0~A11

Burst Address Ordering for Burst Length

Burst Length	Starting Address(A2, A1, A0)	Sequential Mode	Interleave Mode
2	xx0	0, 1	0, 1
	xx1	1, 0	1, 0
4	x00	0, 1, 2, 3	0, 1, 2, 3
	x01	1, 2, 3, 0	1, 0, 3, 2
	x10	2, 3, 0, 1	2, 3, 0, 1
	x11	3, 0, 1, 2	3, 2, 1, 0
8	000	0, 1, 2, 3, 4, 5, 6, 7	0, 1, 2, 3, 4, 5, 6, 7
	001	1, 2, 3, 4, 5, 6, 7, 0	1, 0, 3, 2, 5, 4, 7, 6
	010	2, 3, 4, 5, 6, 7, 0, 1	2, 3, 0, 1, 6, 7, 4, 5
	011	3, 4, 5, 6, 7, 0, 1, 2	3, 2, 1, 0, 7, 6, 5, 4
	100	4, 5, 6, 7, 0, 1, 2, 3	4, 5, 6, 7, 0, 1, 2, 3
	101	5, 6, 7, 0, 1, 2, 3, 4	5, 4, 7, 6, 1, 0, 3, 2
	110	6, 7, 0, 1, 2, 3, 4, 5	6, 7, 4, 5, 2, 3, 0, 1
	111	7, 0, 1, 2, 3, 4, 5, 6	7, 6, 5, 4, 3, 2, 1, 0

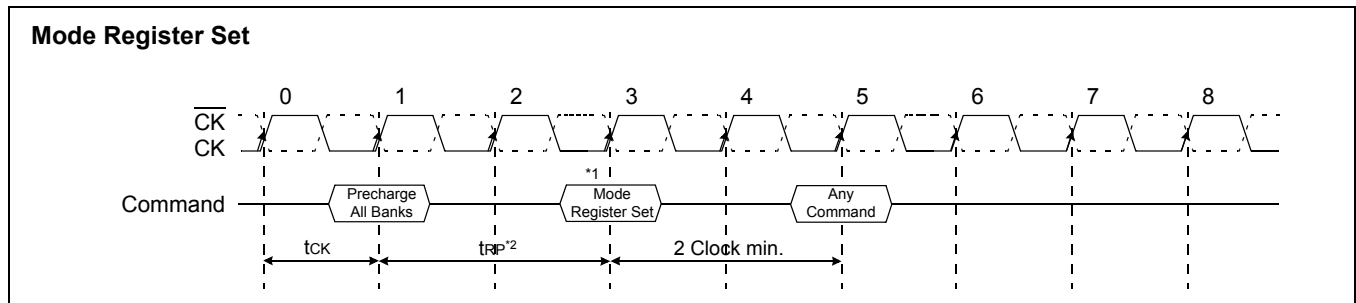

*1 : MRS can be issued only at all bank precharge state.

*2 : Minimum tRP is required to issue MRS command.

7.3 Extended Mode Register Set(EMRS)

The extended mode register stores the data for enabling or disabling DLL, and selecting output driver size. The default value of the extended mode register is not defined, therefore the extended mode register must be written after power up for enabling or disabling DLL. The extended mode register is written by asserting low on CS, RAS, CAS, WE and high on BA0(The DDR SDRAM should be in all bank precharge with CKE already high prior to writing into the extended mode register). The state of address pins A0 ~ A11 and BA1 in the same cycle as CS, RAS, CAS and WE going low are written in the extended mode register. Two clock cycles are required to complete the write operation in the extended mode register. The mode register contents can be changed using the same command and clock cycle requirements during operation as long as all banks are in the idle state. A0 is used for DLL enable or disable. "High" on BA0 is used for EMRS. All the other address pins except A0, A1, A6, A11 and BA0 must be set to low for proper EMRS operation. Refer to the table for specific codes.

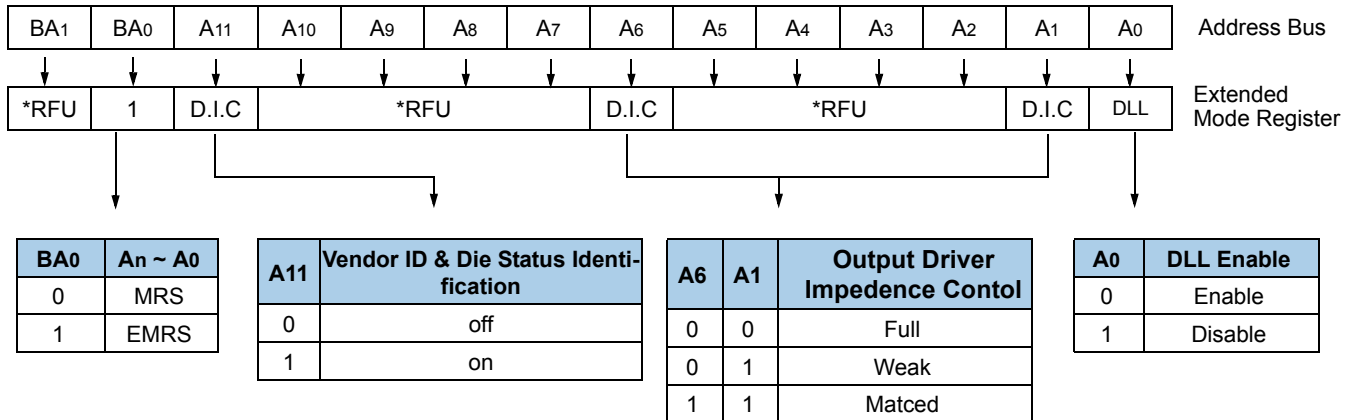

*RFU : Should stay " 0" during EMRS cycle.

Figure 7. Extend Mode Register set

DLL Enable/Disable

The DLL must be enabled for normal operation. DLL enable is required during powerup initialization, and upon returning to normal operation after having disabled the DLL for the purpose of debug or evaluation (upon exiting Self Refresh Mode, the DLL is enabled automatically). Any time the DLL is enabled, 200 clock cycles must occur before a READ command can be issued.

Output Drive Strength

The normal drive strength for all outputs is specified to be SSTL_2, Class II. Samsung supports a weak driver strength option, intended for lighter load and/or point-to-point environments. I-V curves for the normal drive strength and weak drive strength are included in 11.1~2 of this document.

MANUFACTURERS VENDOR CODE AND DIE STATUS IDENTIFICATION

The Manufacturers Vendor Code, V, is selected by issuing a EXTENDED MODE REGISTER SET command with bits A11 set to one, and bits A0-A10 set to the desired values. When the V function is enabled the 128Mb DDR SDRAM will provide its manufacturers vendor code and die status identification on DQ[1:0].

DQ[1:0]	Vendor ID/DSI
00	Samsung / Pass
01	Samsung / Fail
10	Reserved / Pass
11	Reserved / Fail

8.0 Input/Output Function Description

SYMBOL	TYPE	DESCRIPTION
CK, \overline{CK}	Input	Clock : CK and \overline{CK} are differential clock inputs. All address and control input signals are sampled on the positive edge of CK and negative edge of \overline{CK} . Output (read) data is referenced to both edges of CK. Internal clock signals are derived from CK/ \overline{CK} .
CKE	Input	Clock Enable : CKE HIGH activates, and CKE LOW deactivates internal clock signals, and device input buffers and output drivers. Taking CKE Low provides PRECHARGE POWER-DOWN and SELF REFRESH operation (all banks idle), or ACTIVE POWER DOWN (row ACTIVE in any bank). CKE is synchronous for POWER DOWN entry and exit, and for SELF REFRESH entry. CKE is asynchronous for SELF REFRESH exit, and for output disable. CKE must be maintained high throughout READ and WRITE accesses. Input buffers, excluding CK, \overline{CK} and CKE are disabled during POWER DOWN. Input buffers, excluding CKE are disabled during SELF REFRESH. CKE is an SSTL_2 input, but will detect an LVCMOS Low level after V_{DD} is applied upon 1st power up, After V_{REF} has become stable during the power on and initialization sequence, it must be maintained for proper operation of the CKE receiver. For proper SELF REFRESH entry and exit, V_{REF} must be maintained to this input.
\overline{CS}	Input	Chip Select : \overline{CS} enables (registered LOW) and disables (registered HIGH) the command decoder. All commands are masked when \overline{CS} is registered HIGH. \overline{CS} provides for external bank selection on systems with multiple banks. \overline{CS} is considered part of the command code.
\overline{RAS} , \overline{CAS} , \overline{WE}	Input	Command Inputs : \overline{RAS} , \overline{CAS} and \overline{WE} (along with \overline{CS}) define the command being entered.
LDM, (UDM)	Input	Input Data Mask : DM is an input mask signal for write data. Input data is masked when DM is sampled HIGH along with that input data during a WRITE access. DM is sampled on both edges of DQS. Although DM pins are input only, the DM loading matches the DQ and DQS loading. For the x16, LDM corresponds to the data on DQ0~D7 ; UDM corresponds to the data on DQ8~DQ15. DM may be driven high, low, or floating during READS.
BA0, BA1	Input	Bank Address Inputs : BA0 and BA1 define to which bank an ACTIVE, READ, WRITE or PRECHARGE command is being applied.
A [0 : 11]	Input	Address Inputs : Provide the row address for ACTIVE commands, and the column address and AUTO PRECHARGE bit for READ/WRITE commands, to select one location out of the memory array in the respective bank. A10 is sampled during a PRECHARGE command to determine whether the PRECHARGE applies to one bank (A10 LOW) or all banks (A10 HIGH). If only one bank is to be precharged, the bank is selected by BA0, BA1. The address inputs also provide the op code during a MODE REGISTER SET command. BA0 and BA1 define which mode register is loaded during the MODE REGISTER SET command (MRS or EMRS).
DQ	I/O	Data Input/Output : Data bus
LDQS, (U)DQS	I/O	Data Strobe : Output with read data, input with write data. Edge-aligned with read data, centered in write data. Used to capture write data. For the x16, LDQS corresponds to the data on DQ0~D7 ; UDQS corresponds to the data on DQ8~DQ15.
NC	-	No Connect : No internal electrical connection is present.
V_{DDQ}	Supply	DQ Power Supply : +2.5V \pm 0.2V.
V_{SSQ}	Supply	DQ Ground.
V_{DD}	Supply	Power Supply : +2.5V \pm 0.2V.
V_{SS}	Supply	Ground.
V_{REF}	Input	SSTL_2 reference voltage.

9.0 Command Truth Table

(V=Valid, X=Don't Care, H=Logic High, L=Logic Low)

COMMAND		CKEn-1	CKEn	\overline{CS}	\overline{RAS}	\overline{CAS}	\overline{WE}	BA0,1	A10/AP	A0 ~ A9, A11	Note	
Register	Extended MRS	H	X	L	L	L	L	OP CODE			1, 2	
Register	Mode Register Set	H	X	L	L	L	L	OP CODE			1, 2	
Refresh	Auto Refresh	H	H	L	L	L	H	X			3	
	Entry		L								3	
	Self Refresh	Exit	L	H	L	H	H	H	X	X		3
				H		X	X				X	
Bank Active & Row Addr.		H	X	L	L	H	H	V	Row Address			
Read & Column Address	Auto Precharge Disable	H	X	L	H	L	H	V	L	Column Address		4
	Auto Precharge Enable								H			4
Write & Column Address	Auto Precharge Disable	H	X	L	H	L	L	V	L	Column Address		4
	Auto Precharge Enable								H			4, 6
Burst Stop		H	X	L	H	H	L	X			7	
Precharge	Bank Selection	H	X	L	L	H	L	V	L	X		
	All Banks							X	H			5
Active Power Down	Entry	H	L	H	X	X	X	X				
				L	V	V	V					
Exit	Exit	L	H	X	X	X	X	X				
				L	V	V	V					
Precharge Power Down Mode	Entry	H	L	H	X	X	X	X				
				L	H	H	H					
	Exit	L	H	H	X	X	X	X				
				L	V	V	V					
UDM/LDM for x16		H		X				X			8	
No operation (NOP) : Not defined		H	X	H	X	X	X	X				9
				L	H	H	H					9

Note :

- OP Code : Operand Code. A0 ~ A11 & BA0 ~ BA1 : Program keys. (@EMRS/MRS)
- EMRS/MRS can be issued only at all banks precharge state.
A new command can be issued 2 clock cycles after EMRS or MRS.
- Auto refresh functions are same as the CBR refresh of DRAM.
The automatical precharge without row precharge command is meant by "Auto".
Auto/self refresh can be issued only at all banks precharge state.
- BA0 ~ BA1 : Bank select addresses.
If both BA0 and BA1 are "Low" at read, write, row active and precharge, bank A is selected.
If BA0 is "High" and BA1 is "Low" at read, write, row active and precharge, bank B is selected.
If BA0 is "Low" and BA1 is "High" at read, write, row active and precharge, bank C is selected.
If both BA0 and BA1 are "High" at read, write, row active and precharge, bank D is selected.
- If A10/AP is "High" at row precharge, BA0 and BA1 are ignored and all banks are selected.
- During burst write with auto precharge, new read/write command can not be issued.
Another bank read/write command can be issued after the end of burst.
New row active of the associated bank can be issued at TRP after the end of burst.
- Burst stop command is valid at every burst length.
- UDM/LDM(x16 only) sampled at the rising and falling edges of the UDQS/LDQS and Data-in are masked at the both edges (Write UDM/LDM latency is 0).
- This combination is not defined for any function, which means "No Operation(NOP)" in DDR SDRAM.

2M x 16Bit x 4 Banks Double Data Rate SDRAM

10.0 General Description

The K4H281638L is 134,217,728 bits of double data rate synchronous DRAM organized as 4x 2,097,152 words by 16bits, fabricated with SAMSUNG's high performance CMOS technology. Synchronous features with Data Strobe allow extremely high performance up to 500Mb/s per pin. I/O transactions are possible on both edges of DQS. Range of operating frequencies, programmable burst length and programmable latencies allow the device to be useful for a variety of high performance memory system applications.

11.0 Absolute Maximum Rating

Parameter	Symbol	Value	Unit
Voltage on any pin relative to V_{SS}	V_{IN}, V_{OUT}	-0.5 ~ 3.6	V
Voltage on V_{DD} & V_{DDQ} supply relative to V_{SS}	V_{DD}, V_{DDQ}	1.0 ~ 3.6	V
Storage temperature	T_{STG}	-55 ~ +150	°C
Power dissipation	P_D	1	W
Short circuit current	I_{OS}	50	mA

Note : Permanent device damage may occur if ABSOLUTE MAXIMUM RATINGS are exceeded.
Functional operation should be restricted to recommend operation condition.
Exposure to higher than recommended voltage for extended periods of time could affect device reliability.

12.0 DC Operating Conditions

Recommended operating conditions(Voltage referenced to $V_{SS}=0V$, $T_A=0$ to $70^{\circ}C$)

Parameter	Symbol	Min	Max	Unit	Note
Supply voltage (for device with a nominal V_{DD} of 2.5V for DDR333, 400)	V_{DD}	2.3	2.7	V	
Supply voltage (for device with a nominal V_{DD} of 2.5V for DDR500)	V_{DD}	2.375	2.625	V	
I/O Supply voltage (for device with a nominal V_{DD} of 2.5V for DDR333, 400)	V_{DDQ}	2.3	2.7	V	
I/O Supply voltage (for device with a nominal V_{DD} of 2.5V for DDR500)	V_{DDQ}	2.375	2.625	V	
I/O Reference voltage	V_{REF}	$0.49 \cdot V_{DDQ}$	$0.51 \cdot V_{DDQ}$	V	1
I/O Termination voltage(system)	V_{TT}	$V_{REF}-0.04$	$V_{REF}+0.04$	V	2
Input logic high voltage	$V_{IH}(DC)$	$V_{REF}+0.15$	$V_{DDQ}+0.3$	V	
Input logic low voltage	$V_{IL}(DC)$	-0.3	$V_{REF}-0.15$	V	
Input Voltage Level, CK and \overline{CK} inputs	$V_{IN}(DC)$	-0.3	$V_{DDQ}+0.3$	V	
Input Differential Voltage, CK and \overline{CK} inputs	$V_{ID}(DC)$	0.36	$V_{DDQ}+0.6$	V	3
V-I Matching: Pullup to Pulldown Current Ratio	$V_I(\text{Ratio})$	0.71	1.4	-	4
Input leakage current	I_I	-2	2	uA	
Output leakage current	I_{OZ}	-5	5	uA	
Output High Current(Full strength driver) ; $V_{OUT}=V_{DDQ}-0.388V$	I_{OH}	-13.8	-16.1	mA	
Output Low Current(Full strength driver) ; $V_{OUT}=0.388V$	I_{OL}	16.5	19.2	mA	
Output High Current(Weak strength driver) ; $V_{OUT}=V_{DDQ}-0.538V$	I_{OH}	-18.2	-21.8	mA	
Output Low Current(Weak strength driver) ; $V_{OUT}=0.538V$	I_{OL}	20.2	24.5	mA	
Output High Current(Matched strength driver) ; $V_{OUT}=V_{DDQ}-0.6505V$	I_{OH}	-15.5	-18.9	mA	
Output Low Current(Matched strength driver) ; $V_{OUT}=0.6505V$	I_{OL}	17	21.3	mA	

Note :

- V_{REF} is expected to be equal to $0.5 \cdot V_{DDQ}$ of the transmitting device, and to track variations in the dc level of same. Peak-to-peak noise on V_{REF} may not exceed +/-2% of the dc value.
- V_{TT} is not applied directly to the device. V_{TT} is a system supply for signal termination resistors, is expected to be set equal to V_{REF} , and must track variations in the DC level of V_{REF}
- V_{ID} is the magnitude of the difference between the input level on CK and the input level on \overline{CK} .
- The ratio of the pullup current to the pulldown current is specified for the same temperature and voltage, over the entire temperature and voltage range, for device drain to source voltages from 0.25V to 1.0V. For a given output, it represents the maximum difference between pullup and pulldown drivers due to process variation. The full variation in the ratio of the maximum to minimum pullup and pulldown current will not exceed 1.7 for device drain to source voltages from 0.1 to 1.0.

13.0 DDR SDRAM Spec Items & Test Conditions

Conditions	Symbol
Operating current - One bank Active-Precharge; tRC=tRCmin; tCK= 6ns for DDR333, 5ns for DDR400, 4ns for DDR500; DQ,DM and DQS inputs changing once per clock cycle; address and control inputs changing once every two clock cycles.	IDD0
Operating current - One bank operation ; One bank open, BL=4, Reads - Refer to the following page for detailed test condition	IDD1
Precharge power-down standby current; All banks idle; power - down mode; CKE = <V _{IL} (max); tCK=6ns for DDR333, 5ns for DDR400, 4ns for DDR500; V _{IN} = V _{REF} for DQ,DQS and DM.	IDD2P
Precharge Floating standby current; CS > = V _{IH} (min);All banks idle; CKE > = V _{IH} (min); tCK=6ns for DDR333, 5ns for DDR400, 4ns for DDR500; Address and other control inputs changing once per clock cycle; V _{IN} = V _{REF} for DQ,DQS and DM	IDD2F
Precharge Quiet standby current; CS > = V _{IH} (min); All banks idle; CKE > = V _{IH} (min); tCK=6ns for DDR333, 5ns for DDR400, 4ns for DDR500; Address and other control inputs stable at >= V _{IH} (min) or <=V _{IL} (max); V _{IN} = V _{REF} for DQ ,DQS and DM	IDD2Q
Active power - down standby current ; one bank active; power-down mode; CKE=< V _{IL} (max); tCK=6ns for DDR333, 5ns for DDR400, 4ns for DDR500; V _{IN} = V _{REF} for DQ,DQS and DM	IDD3P
Active standby current; CS >= V _{IH} (min); CKE>=V _{IH} (min); one bank active; active - precharge;tCK=6ns for DDR333, 5ns for DDR400, 4ns for DDR500; DQ, DQS and DM inputs changing twice per clock cycle; address and other control inputs changing once per clock cycle	IDD3N
Operating current - burst read; Burst length = 2; reads; contiguous burst; One bank active; address and control inputs changing once per clock cycle; CL=2.5 at tCK=6ns for DDR333, CL=3 at tCK=5ns for DDR400, tCK=4ns for DDR500; 50% of data changing on every transfer; Iout = 0 mA	IDD4R
Operating current - burst write; Burst length = 2; writes; continuous burst; One bank active address and control inputs changing once per clock cycle; CL=2.5 at tCK=6ns for DDR333, 5ns for DDR400, tCK=4ns for DDR500; DQ, DM and DQS inputs changing twice per clock cycle, 50% of input data changing at every burst	IDD4W
Auto refresh current; tRC = tRFC(min) which is 12*tCK for DDR333 at tCK=6ns, 14*tCK for DDR400 at tCK=5ns, 15*tCK for DDR500 at tCK=4ns; distributed refresh	IDD5
Self refresh current; CKE =< 0.2V; External clock on; tCK=6ns for DDR333, 5ns for DDR400, 4ns for DDR500.	IDD6
Operating current - Four bank operation ; Four bank interleaving with BL=4 -Refer to the following page for detailed test condition	IDD7A

14.0 Input/Output Capacitance

(T_A= 25°C, f=100MHz)

Parameter	Symbol	Min	Max	DeltaCap(max)	Unit	Note
Input capacitance (A0 ~ A11, BA0 ~ BA1, CKE, CS, RAS,CAS, WE)	C _{IN1}	1	4	0.5	pF	4
Input capacitance(CK, CK)	C _{IN2}	1	5	0.25	pF	4
Data & DQS input/output capacitance	C _{OUT}	1	6.5	0.5	pF	1,2,3,4
Input capacitance(UDM/LDM for x16)	C _{IN3}	1	6.5		pF	1,2,3,4

Note :

- These values are guaranteed by design and are tested on a sample basis only.
- Although DM is an input -only pin, the input capacitance of this pin must model the input capacitance of the DQ and DQS pins. This is required to match signal propagation times of DQ, DQS, and DM in the system.
- Unused pins are tied to ground.
- This parameter is sampled. V_{DDQ} = +2.5V +0.2V, V_{DD} = +2.5V+0.2V. For all devices, f=100MHz, t_A=25°C, V_{OUT}(DC) = V_{DDQ}/2, V_{OUT}(peak to peak) = 0.2V. DM inputs are grouped with I/O pins - reflecting the fact that they are matched in loading (to facilitate trace matching at the board level)

15.0 Detailed test condition for DDR SDRAM IDD1 & IDD7A

IDD1 : Operating current: One bank operation

1. Typical Case: $V_{DD} = 2.5V$, $T=25^{\circ}C$
Worst Case : $V_{DD} = 2.7V$, $T= 10^{\circ}C$
2. Only one bank is accessed with $t_{RC}(\min)$, Burst Mode, Address and Control inputs on NOP edge are changing once per clock cycle. $I_{out} = 0mA$
3. Timing patterns
 - B3(166Mhz, CL=2.5) : $t_{CK}=6ns$, $CL=2.5$, $BL=4$, $t_{RCD}=3*t_{CK}$, $t_{RC} = 10*t_{CK}$, $t_{RAS}=7*t_{CK}$
Read : A0 N N R0 N N N P0 N N - repeat the same timing with random address changing
*50% of data changing at every burst
 - CC(200Mhz, CL = 3) : $t_{CK} = 5ns$, $CL = 3$, $BL = 4$, $t_{RCD} = 3*t_{CK}$, $t_{RC} = 11*t_{CK}$, $t_{RAS} = 8*t_{CK}$
Read : A0 N N R0 N N N P0 N N - repeat the same timing with random address changing
*50% of data changing at every transfer
 - CD(250Mhz, CL = 3) : $t_{CK} = 4ns$, $CL = 3$, $BL = 4$, $t_{RCD} = 4*t_{CK}$, $t_{RC} = 13*t_{CK}$, $t_{RAS} = 10*t_{CK}$
Read : A0 N N N R0 N N N N P0 N N - repeat the same timing with random address changing
*50% of data changing at every transfer

Legend : A=Activate, R=Read, W=Write, P=Precharge, N=DESELECT

IDD7A : Operating current: Four bank operation

1. Typical Case: $V_{DD} = 2.5V$, $T=25^{\circ}C$
Worst Case : $V_{DD} = 2.7V$, $T= 10^{\circ}C$
2. Four banks are being interleaved with $t_{RC}(\min)$, Burst Mode, Address and Control inputs on NOP edge are not changing. $I_{out} = 0mA$
4. Timing patterns
 - B3(166Mhz, CL=2.5) : $t_{CK}=6ns$, $BL=4$, $t_{RRD}=2*t_{CK}$, $t_{RCD}=3*t_{CK}$, $t_{RAS}=5*t_{CK}$
Read : A0 N A1 RA0 A2 RA1 A3 RA2 N RA3 - repeat the same timing with random address changing
*50% of data changing at every burst
 - CC(200Mhz, CL = 3) : $t_{CK} = 5ns$, $BL = 4$, $t_{RRD}=2*t_{CK}$, $t_{RCD} = 3*t_{CK}$, $t_{RAS} = 8*t_{CK}$
Read : A0 N A1 RA0 A2 RA1 A3 RA2 N RA3 - repeat the same timing with random address changing
*50% of data changing at every transfer
 - CD(250Mhz, CL = 3) : $t_{CK} = 4ns$, $CL = 3$, $BL = 4$, $t_{RCD} = 4*t_{CK}$, $t_{RAS} = 10*t_{CK}$
Read : A0 N N A1 RA0 A2 RA1 A3 RA2 N RA3 - repeat the same timing with random address changing
*50% of data changing at every transfer

Legend : A=Activate, R=Read, W=Write, P=Precharge, N=DESELECT

16.0 DDR SDRAM IDD spec table

(V_{DD}=2.7V, T = 10°C)

Symbol		8Mx16 (K4H281638L)			Unit
		CD(DDR500@CL=3)	CC(DDR400@CL=3)	B3(DDR333@CL=2.5)	
IDD0		120	110	100	mA
IDD1		130	120	120	mA
IDD2P		8			mA
IDD2F		40	40	40	mA
IDD2Q		40	40	40	mA
IDD3P		40	35	35	mA
IDD3N		55	55	55	mA
IDD4R		200	180	160	mA
IDD4W		200	180	160	mA
IDD5		200	180	160	mA
IDD6	Normal	3	3	3	mA
IDD7A		300	300	280	mA

17.0 AC Operating Conditions

Parameter/Condition	Symbol	Min	Max	Unit	Note
Input High (Logic 1) Voltage, DQ, DQS and DM signals	$V_{IH}(AC)$	$V_{REF} + 0.31$		V	
Input Low (Logic 0) Voltage, DQ, DQS and DM signals.	$V_{IL}(AC)$		$V_{REF} - 0.31$	V	
Input Differential Voltage, CK and \overline{CK} inputs	$V_{ID}(AC)$	0.7	$V_{DDQ} + 0.6$	V	1
Input Crossing Point Voltage, CK and \overline{CK} inputs	$V_{IX}(AC)$	$0.5 \times V_{DDQ} - 0.2$	$0.5 \times V_{DDQ} + 0.2$	V	2
I/O Reference Voltage	$V_{REF}(AC)$	$0.45 \times V_{DDQ}$	$0.55 \times V_{DDQ}$	V	3

Note :

- V_{ID} is the magnitude of the difference between the input level on CK and the input level on \overline{CK} .
- The value of V_{IX} is expected to equal $0.5 \times V_{DDQ}$ of the transmitting device and must track variations in the dc level of the same.
- V_{REF} is expected to equal $V_{DDQ}/2$ of the transmitting device and to track variations in the DC level of the same.
Peak-to-peak noise (non-common mode) on V_{REF} may not exceed ± 2 percent of the DC value. Thus, from $V_{DDQ}/2$, V_{REF} is allowed $\pm 25mV$ for DC error and an additional $\pm 25mV$ for AC noise. This measurement is to be taken at the nearest V_{REF} by-pass capacitor.

18.0 AC Overshoot/Undershoot specification for Address and Control Pins

Parameter	Specification	
	DDR400	DDR333
Maximum peak amplitude allowed for overshoot	1.5 V	1.5 V
Maximum peak amplitude allowed for undershoot	1.5 V	1.5 V
The area between the overshoot signal and V_{DD} must be less than or equal to	4.5 V-ns	4.5 V-ns
The area between the undershoot signal and GND must be less than or equal to	4.5 V-ns	4.5 V-ns

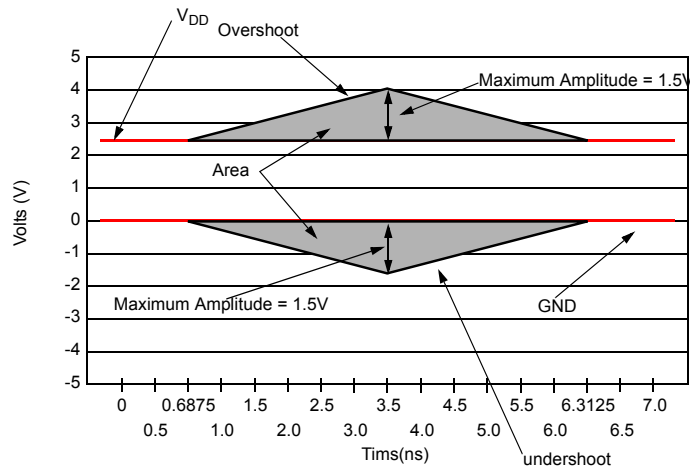

AC overshoot/Undershoot Definition

19.0 Overshoot/Undershoot specification for Data, Strobe and Mask Pins

Parameter	Specification	
	DDR400	DDR333
Maximum peak amplitude allowed for overshoot	1.2 V	1.2 V
Maximum peak amplitude allowed for undershoot	1.2 V	1.2 V
The area between the overshoot signal and V_{DDQ} must be less than or equal to	2.4 V-ns	2.4 V-ns
The area between the undershoot signal and GND must be less than or equal to	2.4 V-ns	2.4 V-ns

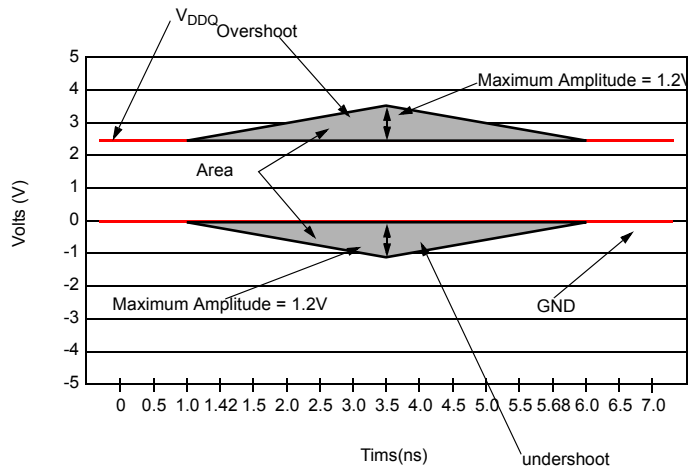

DQ/DM/DQS AC overshoot/Undershoot Definition

20.0 AC Timing Parameters & Specifications

Parameter	Symbol	CD (DDR500@CL=3.0)		CC (DDR400@CL=3.0)		B3 (DDR333@CL=2.5)		Unit	Note	
		Min	Max	Min	Max	Min	Max			
Row cycle time	tRC	52	-	55	-	60	-	ns		
Refresh row cycle time	tRFC	60	-	70	-	72	-	ns		
Row active time	tRAS	36	70K	40	70K	42	70K	ns		
RAS to CAS delay	tRCD	16	-	15	-	18	-	ns		
Row precharge time	tRP	16	-	15	-	18	-	ns		
Row active to Row active delay	tRRD	12	-	10	-	12	-	ns		
Write recovery time	tWR	12	-	15	-	15	-	ns		
Last data in to Read command	tWTR	2	-	2	-	1	-	tCK		
Clock cycle time	tCK	CL=2.5	6	10	6	10	6	10	ns	
		CL=3.0	4	8	5	8	-	-		
Clock high level width	tCH	0.45	0.55	0.45	0.55	0.45	0.55	tCK		
Clock low level width	tCL	0.45	0.55	0.45	0.55	0.45	0.55	tCK		
DQS-out access time from CK/CK	tDQSK	-0.6	+0.6	-0.6	+0.6	-0.6	+0.6	ns		
Output data access time from CK/CK	tAC	-0.6	+0.6	-0.7	+0.7	-0.7	+0.7	ns		
Data strobe edge to output data edge	TSOP	tDQSQ	-	0.4	-	0.4	-	0.45	ns	22
Read Preamble	tRPRE	0.9	1.1	0.9	1.1	0.9	1.1	tCK		
Read Postamble	tRPST	0.4	0.6	0.4	0.6	0.4	0.6	tCK		
CK to valid DQS-in	tDQSS	0.85	1.15	0.72	1.28	0.75	1.25	tCK		
DQS-in setup time	tWPRES	0	-	0	-	0	-	ns	13	
DQS-in hold time	tWPREH	0.35	-	0.25	-	0.25	-	tCK		
DQS falling edge to CK rising-setup time	tDSS	0.2	-	0.2	-	0.2	-	tCK		
DQS falling edge from CK rising-hold time	tDSH	0.2	-	0.2	-	0.2	-	tCK		
DQS-in high level width	tDQSH	0.4	-	0.35	-	0.35	-	tCK		
DQS-in low level width	tDQSL	0.4	-	0.35	-	0.35	-	tCK		
Address and Control Input setup time(fast)	tIS	0.9	-	0.6	-	0.75	-	ns	15, 17-19	
Address and Control Input hold time(fast)	tIH	0.9	-	0.6	-	0.75	-	ns	15, 17-19	
Address and Control Input setup time(slow)	tIS	0.9	-	0.7	-	0.8	-	ns	16-19	
Address and Control Input hold time(slow)	tIH	0.9	-	0.7	-	0.8	-	ns	16-19	
Data-out high impedance time from CK/CK	tHZ	-0.7	+0.7	-0.65	+0.65	-0.7	+0.7	ns	11	
Data-out low impedance time from CK /CK	tLZ	-0.7	+0.7	-0.65	+0.65	-0.7	+0.7	ns	11	
Mode register set cycle time	tMRD	8	-	10	-	12	-	ns		
DQ & DM setup time to DQS	tDS	0.4	-	0.4	-	0.45	-	ns	j, k	
DQ & DM hold time to DQS	tDH	0.4	-	0.4	-	0.45	-	ns	j, k	
Control & Address input pulse width	tIPW	2.2	-	2.2	-	2.2	-	ns	18	
DQ & DM input pulse width	tDIPW	1.75	-	1.75	-	1.75	-	ns	18	
Exit self refresh to non-Read command	tXSNR	75	-	75	-	75	-	ns		
Exit self refresh to read command	tXSRD	200	-	200	-	200	-	tCK		
Refresh interval time	tREFI		15.6		15.6		15.6	us	14	
Output DQS valid window	tQH	tHP -tQHS	-	tHP -tQHS	-	tHP -tQHS	-	ns	21	
Clock half period	tHP	tCLmin or tCHmin	-	tCLmin or tCHmin	-	tCLmin or tCHmin	-	ns	20, 21	
Data hold skew factor	TSOP	tQHS	0.4		0.5		0.55	ns	21	
DQS write postamble time	tWPST	0.4	0.6	0.4	0.6	0.4	0.6	tCK	12	
Active to Read with Auto precharge command	tRAP	16	-	15	-	18	-			
Autoprecharge write recovery + Precharge time	tDAL	(tWR/tCK) + (tRP/tCK)	-	(tWR/tCK) + (tRP/tCK)	-	(tWR/tCK) + (tRP/tCK)	-	tCK	23	
Power Down Exit	tPDEX	1	-	1	-	1	-	tCK		

21.0 System Characteristics for DDR SDRAM

The following specification parameters are required in systems using DDR400 and DDR333 devices to ensure proper system performance. These characteristics are for system simulation purposes and are guaranteed by design.

Table 1 : Input Slew Rate for DQ, DQS, and DM

AC CHARACTERISTICS PARAMETER	SYMBOL	DDR400		DDR333		Units	Notes
		MIN	MAX	MIN	MAX		
DQ/DM/DQS input slew rate measured between $V_{IH}(DC)$, $V_{IL}(DC)$ and $V_{IL}(DC)$, $V_{IH}(DC)$	DCSLEW	0.5	4.0	0.5	4.0	V/ns	a, l

Table 2 : Input Setup & Hold Time Derating for Slew Rate

Input Slew Rate	Δt_{IS}	Δt_{IH}	Units	Notes
0.5 V/ns	0	0	ps	i
0.4 V/ns	+50	0	ps	i
0.3 V/ns	+100	0	ps	i

Table 3 : Input/Output Setup & Hold Time Derating for Slew Rate

Input Slew Rate	Δt_{DS}	Δt_{DH}	Units	Notes
0.5 V/ns	0	0	ps	k
0.4 V/ns	+75	+75	ps	k
0.3 V/ns	+150	+150	ps	k

Table 4 : Input/Output Setup & Hold Derating for Rise/Fall Delta Slew Rate

Delta Slew Rate	Δt_{DS}	Δt_{DH}	Units	Notes
+/- 0.0 V/ns	0	0	ps	j
+/- 0.25 V/ns	+50	+50	ps	j
+/- 0.5 V/ns	+100	+100	ps	j

Table 5 : Output Slew Rate Characteristic (X4, X8 Devices only)

Slew Rate Characteristic	Typical Range (V/ns)	Minimum (V/ns)	Maximum (V/ns)	Notes
Pullup Slew Rate	1.2 ~ 2.5	1.0	4.5	a,c,d,f,g,h
Pulldown slew	1.2 ~ 2.5	1.0	4.5	b,c,d,f,g,h

Table 6 : Output Slew Rate Characteristic (X16 Devices only)

Slew Rate Characteristic	Typical Range (V/ns)	Minimum (V/ns)	Maximum (V/ns)	Notes
Pullup Slew Rate	1.2 ~ 2.5	0.7	5.0	a,c,d,f,g,h
Pulldown slew	1.2 ~ 2.5	0.7	5.0	b,c,d,f,g,h

Table 7 : Output Slew Rate Matching Ratio Characteristics

AC CHARACTERISTICS PARAMETER	DDR400		DDR333		Notes
	MIN	MAX	MIN	MAX	
Output Slew Rate Matching Ratio (Pullup to Pulldown)	0.67	1.5	0.67	1.5	e, l

22.0 Component Notes

1. All voltages referenced to V_{SS} .
2. Tests for ac timing, IDD, and electrical, ac and dc characteristics, may be conducted at nominal reference/supply voltage levels, but the related specifications and device operation are guaranteed for the full voltage range specified.
3. Figure 1 represents the timing reference load used in defining the relevant timing parameters of the part. It is not intended to be either a precise representation of the typical system environment nor a depiction of the actual load presented by a production tester. System designers will use IBIS or other simulation tools to correlate the timing reference load to a system environment. Manufacturers will correlate to their production test conditions (generally a coaxial transmission line terminated at the tester electronics).

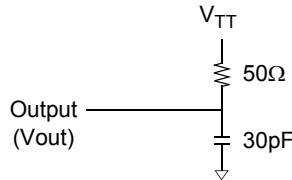

Figure 1 : Timing Reference Load

4. AC timing and IDD tests may use a V_{IL} to V_{IH} swing of up to 1.5 V in the test environment, but input timing is still referenced to V_{REF} (or to the crossing point for CK/\overline{CK}), and parameter specifications are guaranteed for the specified ac input levels under normal use conditions. The minimum slew rate for the input signals is 1 V/ns in the range between $V_{IL}(AC)$ and $V_{IH}(AC)$.
5. The ac and dc input level specifications are as defined in the SSTL_2 Standard (i.e., the receiver will effectively switch as a result of the signal crossing the ac input level and will remain in that state as long as the signal does not ring back above (below) the dc input LOW (HIGH) level.
6. Inputs are not recognized as valid until V_{REF} stabilizes. Exception: during the period before V_{REF} stabilizes, $CKE \leq 0.2V_{DDQ}$ is recognized as LOW.
7. Enables on.chip refresh and address counters.
8. IDD specifications are tested after the device is properly initialized.
9. The CK/\overline{CK} input reference level (for timing referenced to CK/\overline{CK}) is the point at which CK and \overline{CK} cross; the input reference level for signals other than CK/\overline{CK} , is V_{REF} .
10. The output timing reference voltage level is V_{TT} .
11. tHZ and tLZ transitions occur in the same access time windows as valid data transitions. These parameters are not referenced to a specific voltage level but specify when the device output is no longer driving (HZ), or begins driving (LZ).
12. The maximum limit for this parameter is not a device limit. The device will operate with a greater value for this parameter, but system performance (bus turnaround) will degrade accordingly.
13. The specific requirement is that DQS be valid (HIGH, LOW, or at some point on a valid transition) on or before this CK edge. A valid transition is defined as monotonic and meeting the input slew rate specifications of the device. when no writes were previously in progress on the bus, DQS will be transitioning from High-Z to logic LOW. If a previous write was in progress, DQS could be HIGH, LOW, or transitioning from HIGH to LOW at this time, depending on tDQSS.
14. A maximum of eight AUTO REFRESH commands can be posted to any given DDR SDRAM device.
15. For command/address input slew rate ≥ 1.0 V/ns
16. For command/address input slew rate ≥ 0.5 V/ns and < 1.0 V/ns

Component Notes

17. For CK & $\overline{\text{CK}}$ slew rate ≥ 1.0 V/ns
18. These parameters guarantee device timing, but they are not necessarily tested on each device. They may be guaranteed by device design or tester correlation.
19. Slew Rate is measured between $V_{\text{OH}}(\text{AC})$ and $V_{\text{OL}}(\text{AC})$.
20. Min (tCL, tCH) refers to the smaller of the actual clock low time and the actual clock high time as provided to the device (i.e. this value can be greater than the minimum specification limits for tCL and tCH).....For example, tCL and tCH are = 50% of the period, less the half period jitter (tJIT(HP)) of the clock source, and less the half period jitter due to crosstalk (tJIT(crosstalk)) into the clock traces.
21. tQH = tHP - tQHS, where:
 tHP = minimum half clock period for any given cycle and is defined by clock high or clock low (tCH, tCL). tQHS accounts for 1) The pulse duration distortion of on-chip clock circuits; and 2) The worst case push-out of DQS on one transition followed by the worst case pull-in of DQ on the next transition, both of which are, separately, due to data pin skew and output pattern effects, and p-channel to n-channel variation of the output drivers.
22. tDQSQ
 Consists of data pin skew and output pattern effects, and p-channel to n-channel variation of the output drivers for any given cycle.
23. tDAL = (tWR/tCK) + (tRP/tCK)
 For each of the terms above, if not already an integer, round to the next highest integer. Example: For DDR400 at CL=3 and tCK=5ns tDAL = (15 ns / 5 ns) + (15 ns / 5 ns) = (3) + (3)
 tDAL = 6 clocks

23.0 System Notes

a. Pullup slew rate is characterized under the test conditions as shown in Figure 2.

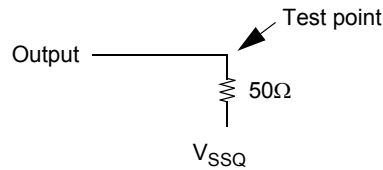

Figure 2 : Pullup slew rate test load

b. Pulldown slew rate is measured under the test conditions shown in Figure 3.

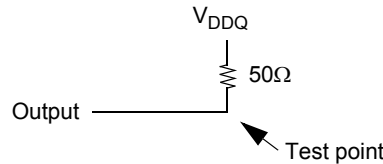

Figure 3 : Pulldown slew rate test load

c. Pullup slew rate is measured between ($V_{DDQ}/2 - 320\text{ mV} \pm 250\text{ mV}$)

Pulldown slew rate is measured between ($V_{DDQ}/2 + 320\text{ mV} \pm 250\text{ mV}$)

Pullup and Pulldown slew rate conditions are to be met for any pattern of data, including all outputs switching and only one output switching.

Example : For typical slew rate, DQ0 is switching

For minimum slew rate, all DQ bits are switching from either high to low, or low to high.

The remaining DQ bits remain the same as for previous state.

d. Evaluation conditions

Typical : 25 °C (T Ambient), $V_{DDQ} = 2.5\text{V}$, typical process

Minimum : 70 °C (T Ambient), $V_{DDQ} = 2.3\text{V}$, slow - slow process

Maximum : 0 °C (T Ambient), $V_{DDQ} = 2.7\text{V}$, fast - fast process

e. The ratio of pullup slew rate to pulldown slew rate is specified for the same temperature and voltage, over the entire temperature and voltage range. For a given output, it represents the maximum difference between pullup and pulldown drivers due to process variation.

f. Verified under typical conditions for qualification purposes.

g. TSOPII package devices only.

h. Only intended for operation up to 500 Mbps per pin.

i. A derating factor will be used to increase tIS and tIH in the case where the input slew rate is below 0.5V/ns as shown in Table 2. The input slew rate is based on the lesser of the slew rates determined by either $V_{IH}(AC)$ to $V_{IL}(AC)$ or $V_{IH}(DC)$ to $V_{IL}(DC)$, similarly for rising transitions.

j. A derating factor will be used to increase tDS and tDH in the case where DQ, DM, and DQS slew rates differ, as shown in Tables 3 & 4.

Input slew rate is based on the larger of AC-AC delta rise, fall rate and DC-DC delta rise, Input slew rate is based on the lesser of the slew rates determined by either $V_{IH}(AC)$ to $V_{IL}(AC)$ or $V_{IH}(DC)$ to $V_{IL}(DC)$, similarly for rising transitions.

The delta rise/fall rate is calculated as:

$$\{1/(\text{Slew Rate1})\} - \{1/(\text{Slew Rate2})\}$$

For example : If Slew Rate 1 is 0.5 V/ns and Slew Rate 2 is 0.4 V/ns, then the delta rise, fall rate is - 0.5ns/V . Using the table given, this would result in the need for an increase in tDS and tDH of 100 ps.

k. Table 3 is used to increase tDS and tDH in the case where the I/O slew rate is below 0.5 V/ns. The I/O slew rate is based on the lesser of the AC - AC slew rate and the DC - DC slew rate. The input slew rate is based on the lesser of the slew rates determined by either $V_{IH}(AC)$ to $V_{IL}(AC)$ or $V_{IH}(DC)$ to $V_{IL}(DC)$, and similarly for rising transitions.

l. DQS, DM, and DQ input slew rate is specified to prevent double clocking of data and preserve setup and hold times. Signal transitions through the DC region must be monotonic.

24.0 IBIS : I/V Characteristics for Input and Output Buffers

DDR SDRAM Output Driver V-I Characteristics

DDR SDRAM Output driver characteristics are defined for full and half strength operation as selected by the EMRS bit A1.

Figures 4, 5 and 6 show the driver characteristics graphically, and tables 8, 9 and 10 show the same data in tabular format suitable for input into simulation tools. The driver characteristics evaluation conditions are:

Typical	25°C	$V_{DD}/V_{DDQ} = 2.5V$, typical process
Minimum	70°C	$V_{DD}/V_{DDQ} = 2.3V$, slow-slow process
Maximum	0°C	$V_{DD}/V_{DDQ} = 2.7V$, fast-fast process

Output Driver Characteristic Curves Notes:

1. The full variation in driver current from minimum to maximum process, temperature and voltage will lie within the outer bounding lines of the V-I curve of Figures 4, 5 and 6.
2. It is recommended that the "typical" IBIS V-I curve lie within the inner bounding lines of the V-I curves of Figures 4, 5 and 6.
3. The full variation in the ratio of the "typical" IBIS pullup to "typical" IBIS pulldown current should be unity +/- 10%, for device drain to source voltages from 0.1 to 1.0. This specification is a design objective only. It is not guaranteed.

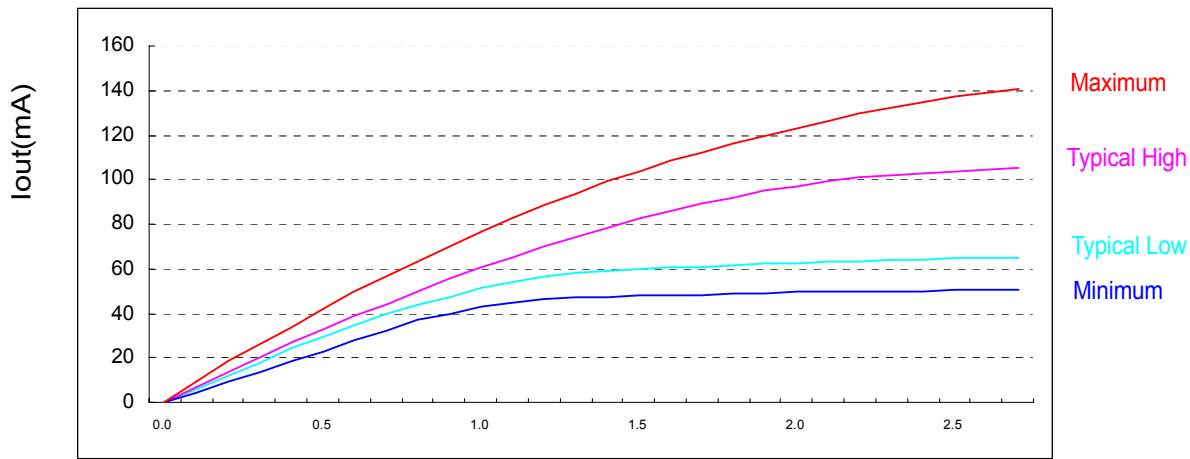

Pull-down Characteristics for Full Strength Output Driver $V_{out}(V)$

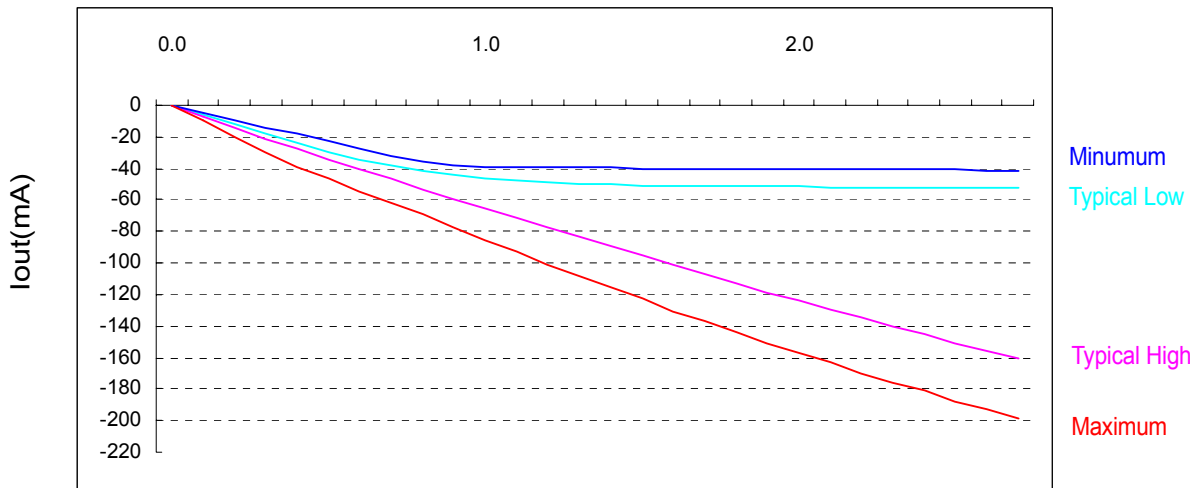

Pull-up Characteristics for Full Strength Output Driver $V_{out}(V)$

Figure 4. I/V characteristics for input/output buffers: Pulldown(above) and pullup(below)

Voltage (V)	Pull-down Current (mA)				Pull-up Current (mA)			
	Typical Low	Typical High	Minimum	Maximum	Typical Low	Typical High	Minimum	Maximum
0.1	6.0	6.8	4.6	9.6	-6.1	-7.6	-4.6	-10.0
0.2	12.2	13.5	9.2	18.2	-12.2	-14.5	-9.2	-20.0
0.3	18.1	20.1	13.8	26.0	-18.1	-21.2	-13.8	-29.8
0.4	24.1	26.6	18.4	33.9	-24.0	-27.7	-18.4	-38.8
0.5	29.8	33.0	23.0	41.8	-29.8	-34.1	-23.0	-46.8
0.6	34.6	39.1	27.7	49.4	-34.3	-40.5	-27.7	-54.4
0.7	39.4	44.2	32.2	56.8	-38.1	-46.9	-32.2	-61.8
0.8	43.7	49.8	36.8	63.2	-41.1	-53.1	-36.0	-69.5
0.9	47.5	55.2	39.6	69.9	-41.8	-59.4	-38.2	-77.3
1.0	51.3	60.3	42.6	76.3	-46.0	-65.5	-38.7	-85.2
1.1	54.1	65.2	44.8	82.5	-47.8	-71.6	-39.0	-93.0
1.2	56.2	69.9	46.2	88.3	-49.2	-77.6	-39.2	-100.6
1.3	57.9	74.2	47.1	93.8	-50.0	-83.6	-39.4	-108.1
1.4	59.3	78.4	47.4	99.1	-50.5	-89.7	-39.6	-115.5
1.5	60.1	82.3	47.7	103.8	-50.7	-95.5	-39.9	-123.0
1.6	60.5	85.9	48.0	108.4	-51.0	-101.3	-40.1	-130.4
1.7	61.0	89.1	48.4	112.1	-51.1	-107.1	-40.2	-136.7
1.8	61.5	92.2	48.9	115.9	-51.3	-112.4	-40.3	-144.2
1.9	62.0	95.3	49.1	119.6	-51.5	-118.7	-40.4	-150.5
2.0	62.5	97.2	49.4	123.3	-51.6	-124.0	-40.5	-156.9
2.1	62.9	99.1	49.6	126.5	-51.8	-129.3	-40.6	-163.2
2.2	63.3	100.9	49.8	129.5	-52.0	-134.6	-40.7	-169.6
2.3	63.8	101.9	49.9	132.4	-52.2	-139.9	-40.8	-176.0
2.4	64.1	102.8	50.0	135.0	-52.3	-145.2	-40.9	-181.3
2.5	64.6	103.8	50.2	137.3	-52.5	-150.5	-41.0	-187.6
2.6	64.8	104.6	50.4	139.2	-52.7	-155.3	-41.1	-192.9
2.7	65.0	105.4	50.5	140.8	-52.8	-160.1	-41.2	-198.2

Table 8. Full Strength Driver Characteristics

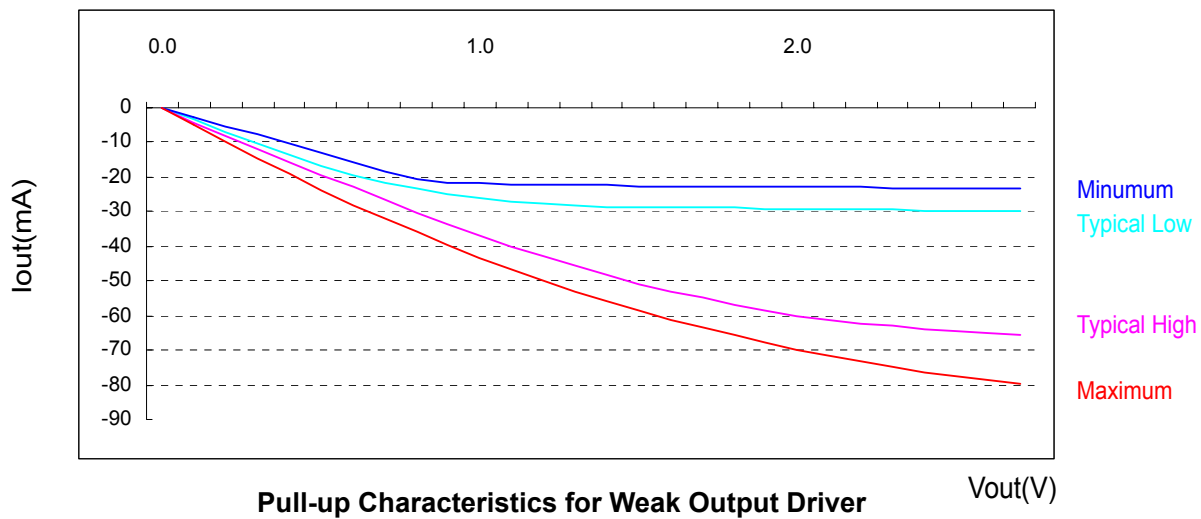
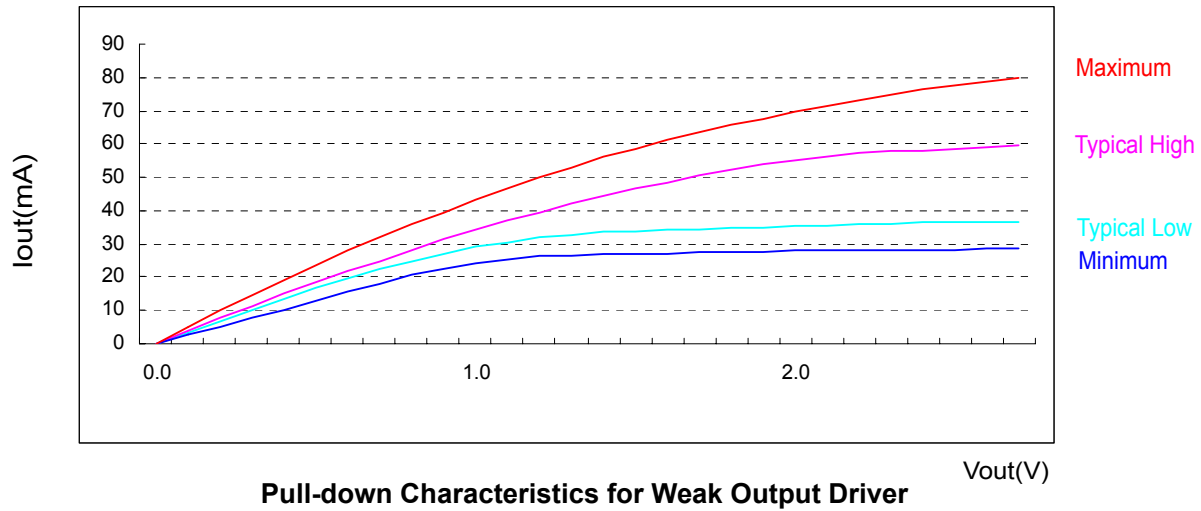

Figure 5. I/V characteristics for input/output buffers: Pulldown(above) and pullup(below)

Voltage (V)	Pull-down Current (mA)				Pull-up Current (mA)			
	Typical Low	Typical High	Minimum	Maximum	Typical Low	Typical High	Minimum	Maximum
0.1	3.4	3.8	2.6	5.0	-3.5	-4.3	-2.6	-5.0
0.2	6.9	7.6	5.2	9.9	-6.9	-8.2	-5.2	-9.9
0.3	10.3	11.4	7.8	14.6	-10.3	-12.0	-7.8	-14.6
0.4	13.6	15.1	10.4	19.2	-13.6	-15.7	-10.4	-19.2
0.5	16.9	18.7	13.0	23.6	-16.9	-19.3	-13.0	-23.6
0.6	19.6	22.1	15.7	28.0	-19.4	-22.9	-15.7	-28.0
0.7	22.3	25.0	18.2	32.2	-21.5	-26.5	-18.2	-32.2
0.8	24.7	28.2	20.8	35.8	-23.3	-30.1	-20.4	-35.8
0.9	26.9	31.3	22.4	39.5	-24.8	-33.6	-21.6	-39.5
1.0	29.0	34.1	24.1	43.2	-26.0	-37.1	-21.9	-43.2
1.1	30.6	36.9	25.4	46.7	-27.1	-40.3	-22.1	-46.7
1.2	31.8	39.5	26.2	50.0	-27.8	-43.1	-22.2	-50.0
1.3	32.8	42.0	26.6	53.1	-28.3	-45.8	-22.3	-53.1
1.4	33.5	44.4	26.8	56.1	-28.6	-48.4	-22.4	-56.1
1.5	34.0	46.6	27.0	58.7	-28.7	-50.7	-22.6	-58.7
1.6	34.3	48.6	27.2	61.4	-28.9	-52.9	-22.7	-61.4
1.7	34.5	50.5	27.4	63.5	-28.9	-55.0	-22.7	-63.5
1.8	34.8	52.2	27.7	65.6	-29.0	-56.8	-22.8	-65.6
1.9	35.1	53.9	27.8	67.7	-29.2	-58.7	-22.9	-67.7
2.0	35.4	55.0	28.0	69.8	-29.2	-60.0	-22.9	-69.8
2.1	35.6	56.1	28.1	71.6	-29.3	-61.2	-23.0	-71.6
2.2	35.8	57.1	28.2	73.3	-29.5	-62.4	-23.0	-73.3
2.3	36.1	57.7	28.3	74.9	-29.5	-63.1	-23.1	-74.9
2.4	36.3	58.2	28.3	76.4	-29.6	-63.8	-23.2	-76.4
2.5	36.5	58.7	28.4	77.7	-29.7	-64.4	-23.2	-77.7
2.6	36.7	59.2	28.5	78.8	-29.8	-65.1	-23.3	-78.8
2.7	36.8	59.6	28.6	79.7	-29.9	-65.8	-23.3	-79.7

Table 9. Weak Driver Characteristics

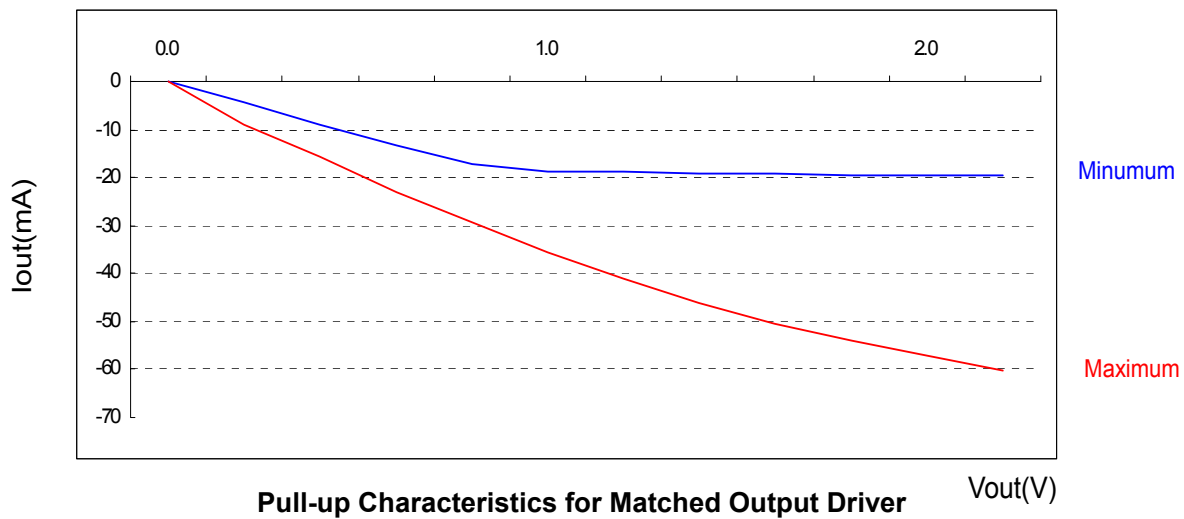
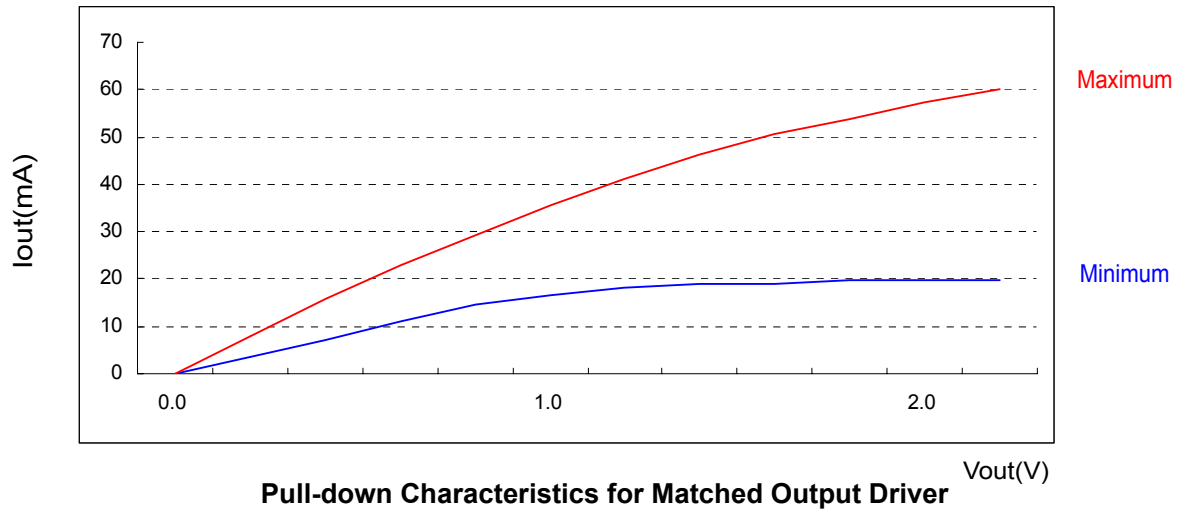

Figure 6. I/V characteristics for input/output buffers: Pulldown(above) and pullup(below)

Voltage (V)	Pull-down Current(mA)		pull-up Current (mA)	
	Minimum	Maximum	Minimum	Maximum
0	0.0	0.0	0.0	0.0
0.2	3.6	7.8	-4.4	-8.8
0.4	7.3	15.8	-8.8	-15.7
0.6	11.0	23.1	-13.3	-23.0
0.8	14.6	29.4	-17.3	-29.4
1.0	16.8	35.5	-18.6	-35.4
1.2	18.3	41.0	-18.9	-41.0
1.4	18.8	46.1	-19.0	-46.0
1.6	19.0	50.5	-19.3	-50.3
1.8	19.6	53.8	-19.5	-53.8
2.0	19.7	57.3	-19.6	-57.2
2.2	19.8	60.1	-19.7	-60.1

Table 10. Matched Driver Characteristics