

**DESCRIPTION**

The LXMG221W-0700030-D0 is a highly reliable 30W solid-state LED lighting driver module with a galvanic isolated output. It is compliant to Energy Star for commercial, industrial and residential applications. It is compatible with 50Hz and 60Hz AC power sources worldwide with standard voltages ranging from 120VAC +/- 10% to 277VAC +/- 10%. The output is a 700mA dimmable constant current source. It complies with UL, CUL and CE standards for safety standards and EMC.

Low voltage dimming control is available when using the dedicated dimming control input leads, DIM(+) and DIM(-). The amplitude of the output LED string current will vary from 10% to 100% corresponding to a 1V<sub>DC</sub> to 10V<sub>DC</sub> signal on DIM(+) input following IEC 60929 Annex E.2.3. A minimum dim level of 10% shall be obtained with DIM(+) input shorted to DIM(-).

**KEY FEATURES**

- Energy Star Compliant
- > 50k Hour Life at 60°C
- Constant Current Output
- 0 – 10V<sub>DC</sub>, PWM and POT Dimmable
- Suitable for Damp Locations IP66
- Suitable for Plenum Locations
- Isolated Output, SELV
- High efficiency/Cool Running
- Universal AC Input
- UL, CUL, and CE Standards E337545
- EU ROHS, REACH Compliant
- Full Protection: OVP, SCP, OTP, Maximum Power Limit
- Small Compact Size

**APPLICATIONS**

Worldwide Residential and Commercial LED Lighting Fixtures such as:

- LED Down Lights

**PRODUCT HIGHLIGHT**

Photo is representative only, actual product may differ

**ORDER INFORMATION**

Part Number	Input Voltage	Output Voltage Range and Full Scale Current (IFS)
LXMG221W-0700030-D0	120V <sub>AC</sub> to 277V <sub>AC</sub> ; 47 to 63Hz	17V to 40V at 700mA

**ABSOLUTE MAXIMUM RATINGS**

AC Input Voltage.....	0 to 305V <sub>AC</sub>
DIM(+) (relative to DIM(-)) .....	-20V to 42.4V
DIM(+) Voltage (relative to OUTPUT(-)) .....	-20V to 42.4V
Operating Humidity .....	5 to 95% (non-condensing)
Input Power .....	38W (Internally Limited)
Output LED String Current .....	810mA (Internally Limited)
Output String Voltage .....	42.4V (Internally Limited)
Output Power.....	34W (Internally Limited)
Case Storage Temperature Range.....	-40°C to 105°C

Note: Exceeding these ratings could cause damage to the device. Currents are positive into, negative out of specified terminal.

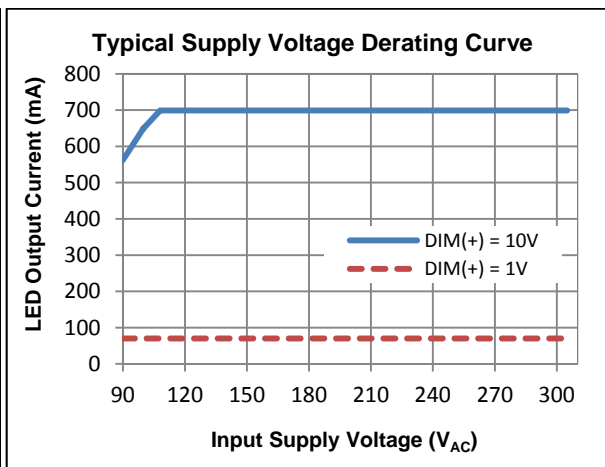
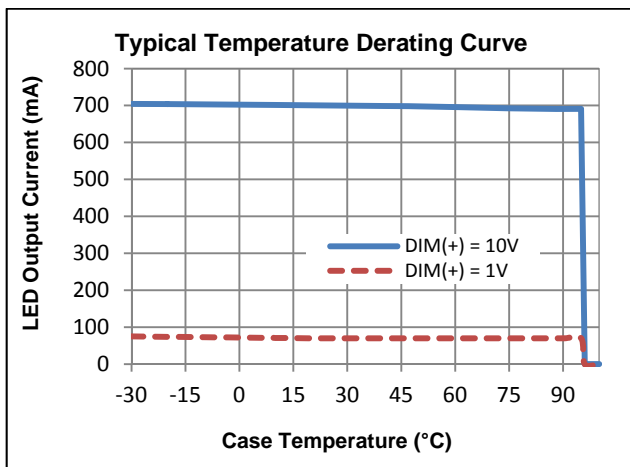
**TYPICAL OPERATING CONDITIONS**

Parameter	Symbol	Test Conditions / Comment	Min	Typ	Max	Units
LED String Output Voltage Range	V <sub>OUT(+)</sub>	At full load current	17		40	V
		At minimum load Current (Dimmed to 10%)	15			
OUT(-) Sink Current	OUT(-) <sub>ISINK</sub>	I <sub>FS</sub>		700		mA
Linear DIM(+) Control Input Voltage Range	V <sub>DIM(+)</sub>		0.95		10	V
DIM(+) Control PWM Frequency Range	V <sub>DIM(+)_PWM</sub>	Open Collector Drive	200		1000	Hz
DIM(+) Control PWM Duty Cycle Range	V <sub>DIM(+)_DC</sub>		9.5		100	%

**ELECTRICAL CHARACTERISTICS**

The following specifications apply over the recommended operating temperature of -20°C to 60°C and the full input voltage range. Except where noted, testing is performed at 25°C, with 120V<sub>AC</sub>, 240V<sub>AC</sub> and 277V<sub>AC</sub>, V<sub>OUT</sub> = 37.5 ± 2.5V, I<sub>OUT</sub> = IFS

Parameter	Symbol	Test Conditions / Comment	Min	Typ	Max	Units
Input Voltage	V <sub>AC</sub>	Line Frequency 47Hz to 63Hz	108		305	V <sub>AC</sub>
Input AC Current	I <sub>AC</sub>	120V <sub>AC</sub> Input		0.265		A
	I <sub>AC</sub>	240V <sub>AC</sub> Input		0.136		
	I <sub>AC</sub>	277V <sub>AC</sub> Input		0.121		
Peak Inrush Current	I <sub>AC</sub>	Measure at 277V <sub>AC</sub> Peak AC Line; Prior to first AC zero crossing		12		A
		Measure at 277V <sub>AC</sub> Peak AC Line; After first AC zero crossing		0.6	5	
Power Factor	pf	V <sub>AC</sub> = 120V <sub>AC</sub> and 277V <sub>AC</sub> , maximum load	0.9			PF
Efficiency	η	V <sub>AC</sub> = 120V <sub>AC</sub> and 277V <sub>AC</sub> , maximum load, after 30 minutes operation	88	90		%
Total Harmonic Distortion	T.H.D.	V <sub>AC</sub> = 120V <sub>AC</sub> and 277V <sub>AC</sub> , maximum load			10	%

**Output Current Source**

Average Sink Current	I <sub>OUT(-)</sub>	V <sub>AC</sub> = 120V <sub>AC</sub> , 240V <sub>AC</sub> and 277V <sub>AC</sub> , full bright	95	100	105	%I <sub>FS</sub>
Line Regulation	I <sub>OUT(-)</sub>	V <sub>AC</sub> = 120V <sub>AC</sub> and 277V <sub>AC</sub> , maximum load			1	%I <sub>FS</sub>

**DC Controlled Dimming (Per IEC 60929, Annex E2.1 - 2.3)**

Dimming Control Voltage	V <sub>DIM</sub>	Maximum Brightness	9.5			V
		Mid (50%) brightness	4.5	4.75	5.0	
		Minimum Brightness	0		1.05	
Output Current	I <sub>FS</sub>	Maximum current; V <sub>DIM</sub> = 10V	665	700	735	mA
		Mid Current ; V <sub>DIM</sub> = 4.75V	47.5	50	52.5	
		Minimum current; V <sub>DIM</sub> = 1V	8	10	12	
Dimming Control Current	I <sub>CONT</sub>	The LED Driver sources DIM current	1.19	1.25	1.37	mA

**Start up**

Turn-on Time	t <sub>START</sub>	Cold Start to 90% I <sub>FS</sub>		150	200	mS
Turn-off Time	t <sub>TURNOFF</sub>	Full on to 10% I <sub>FS</sub>			100	
Power On Overshoot	I <sub>OUT(-)</sub>	Turning Power On			10	%I <sub>FS</sub>
Operating ambient <sup>1</sup>	T <sub>AMBIENT</sub>	Ambient implies air surrounding unit	-30		60	°C
Cold Start Temperature	T <sub>START</sub>	Minimum cold start up temperature	-30			°C

**Protection**

OV threshold	V <sub>OUT(+)</sub>	Relative to V <sub>OUT(-)</sub> ; I <sub>OUT(-)</sub> = 0 (open circuit);	41	41.2	42.4	V <sub>PK</sub>
Maximum case hot spot <sup>1</sup>	T <sub>SD</sub>	Just prior to thermal shutdown.	90	105	110	°C

<sup>1</sup>The unit will operate continuously at full power in the operating ambient range. With an elevated ambient temperature, the unit will shut down prior to reaching a hot spot case temperature in excess of the specified maximum, when the unit cools approximately 8°C it will recover.

**Safety & EMC Compliance**

UL/CUL /CE Safety	UL 8750, UL1310 Class 2	
	Canada: CAN/CSA-C22.2 No. 223 Class 2	
	EN 60598-1&2; 61347-1, EN61347-2-13	
FCC Title 47, Part 15, Class B	Conducted and Radiated Emission	
EN 55015; CISPR22 Class B	Conducted emission (Mains and Dimming Terminals)	
EN 61000-3-2 Class C; ANSI C82.77	Power Factor and Harmonic Current Emissions	
EN 61000-3-3	Voltage Fluctuations and Flicker	
EN 61547	EN61000-4-2	Electrostatic Discharge Immunity
	EN61000-4-3	Radiated Susceptibility test
	EN61000-4-4	Electrical Fast Transient
	EN61000-4-5	Surge Immunity Test (2kV)
	EN61000-4-6	Conducted Susceptibility Immunity test
	EN61000-4-8	Power Frequency Magnetic Field Immunity
	EN61000-4-11	Voltage Dips and interruption immunity
IEC 62384	Performance requirements for AC or DC supplied Control Gear for LED Modules	
IEEE C.62-41-1991	100kHz, 2kV ring wave per Energy Star (Pending)	
Energy Star Sound	< 24dBA; Class A sound rating per Energy Star (at all DIMMING settings) (Pending)	
Life Expectancy	50,000 hours @ 100% duty at ambient temperature 60°C and max load	
Environmental Standards	EU RoHS, REACH	

**LEAD DESCRIPTION**

Name	Description
<b>INPUT TERMINAL LEADS (18AWG plenum rated)</b>	
AC LINE	Main Input Power Supply Line (120V <sub>AC</sub> to 277V <sub>AC</sub> ) – Brown wire
AC NEUTRAL	Main Input Power Supply Neutral- Blue wire
<b>CONTROL TERMINAL LEADS (22 or 24 AWG plenum rated)</b>	
DIM(+)	Analog Dimming Input – Purple wire
DIM(-)	Dimming Return – Grey wire
<b>OUTPUT TERMINALS (18AWG plenum rated)</b>	
OUTPUT(+)	LED String Anode Voltage (High Side) – Red wire
OUTPUT(-)	LED String Cathode Voltage (Low Side) – Yellow wire



**LXMG221W-0700030-D0**

**30W 700mA Dimmable LED Driver Module**

**PRODUCTION DATASHEET**

**CONDITIONS OF ACCEPTABILITY**

The components have been judged on the basis of the required spacings in the Standard for Class 2 Power Units, UL 1310.

The input and output leads are 18 AWG, rated min. 300V, 105°C, VW-1. The suitability of the leads shall be determined in each end-use application. The leads are suitable for field wiring, except for when installed with alternate lead colors below, are suitable for factory wiring only.

The polymeric housing is rated V-0 and has been subjected to a ball-impact and mold stress relief tests. The need for a suitable enclosure shall be considered in the end product.

The component has been evaluated for dry and damp locations, where the humidity conditioning and dielectric tests were conducted per UL 8750.

The maximum temperature measured on housing outside surface was 56°C during the Temperature Test when shifted to Ambient Temperature 40°C. The temperature test was conducted without potting compound. The necessity for repeating the Temperature Test shall be determined in each end use application.

A proper mechanical, electrical and fire enclosure shall be provided in the end-use application that is in compliance with all the applicable requirements of the end-use application.

Testing was on a 20 A branch circuit. If used on a branch circuit greater than this, additional testing may be necessary.

The LED driver is rated as noted in the Electrical Ratings Table above, and the outputs comply with the requirements for Class 2. The need for additional evaluation shall be considered in the end product if used beyond these ratings.

The LED driver is provided with dimmer leads for connecting an external dimmer. The leads colors are shown as below. The dimmer circuit is considered as Class 2 circuit. The routing of the Dimming leads shall be determined in the end use application.

<b>Lead Function</b>	<b>Color</b>
AC LINE	BROWN
AC NEUTRAL	BLUE
OUTPUT(+)	RED
OUTPUT(-)	YELLOW
DIM(-)	GRAY
DIM(+)	PURPLE

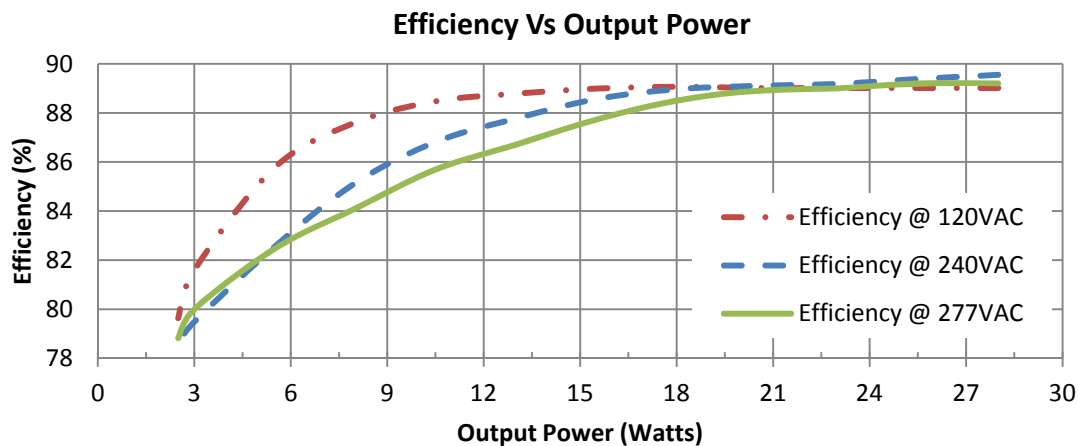
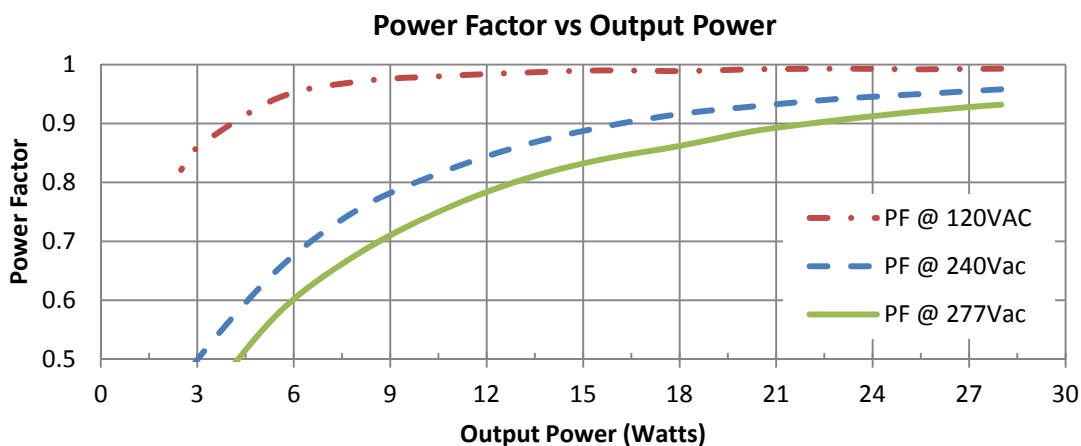
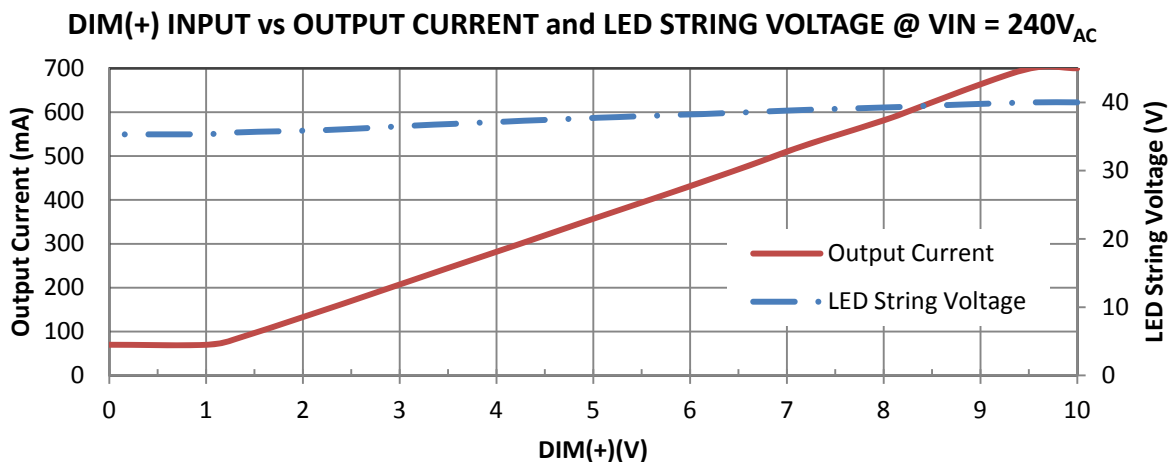
**TYPICAL CHARACTERISTIC CHARTS 25°C**

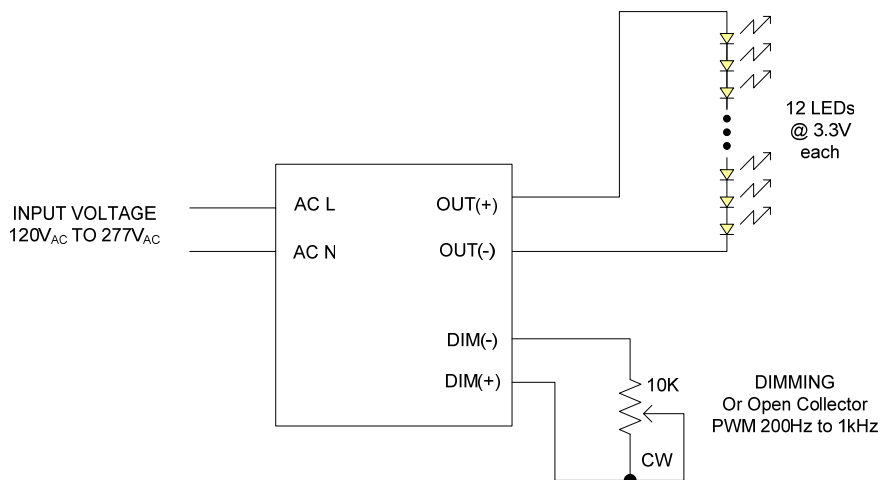
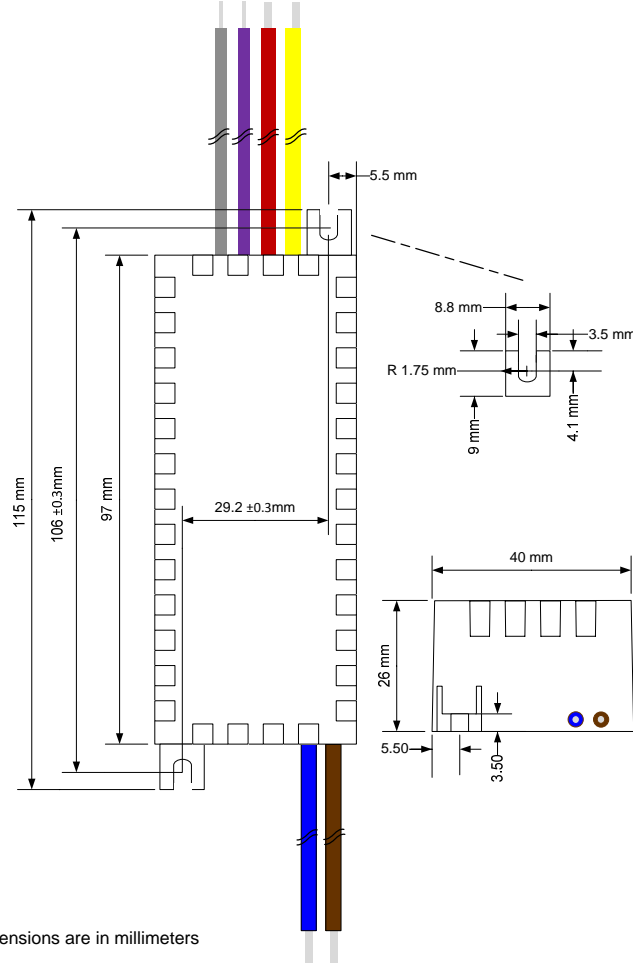
**APPLICATION INFORMATION**

**MECHANICAL DRAWING**

Wire length is 210mm ± 10mm, stripped 12mm ± 5mm UL1015 AWG#18 16/30 stranded 105°C Input & Output wires; AWG#22 or 24 stranded Control wires, all wires tinned. Please insure the wire nuts are installed correctly to prevent intermittent operation. Connecting the AC input to Control or Output wires will result in damage to the module.



**LXMG221W-0700030-D0**

**30W 700mA Dimmable LED Driver Module**

**PRODUCTION DATASHEET**

**NOTES**

PRODUCTION DATA – Information contained in this document is proprietary to Microsemi and is current as of publication date. This document may not be modified in any way without the express written consent of Microsemi. Product processing does not necessarily include testing of all parameters. Microsemi reserves the right to change the configuration and performance of the product and to discontinue product at any time.