



M2716/M2716M

16K (2K x 8) UV ERASABLE PROM

Military

- **Military Temperature Range**
M2716M: -55°C to +125°C (T_C)
M2716: -55°C to +100°C (T_C)
- **5V ± 10% V_{CC}**
- **Pin Compatible to Intel's M2732A 32K EPROM**
- **Fast Access Time: 450 ns Maximum**
- **Static Standby Mode**
- **Low Power Dissipation of 165 mW Maximum Standby Power**
- **Inputs and Outputs TTL Compatible During Read and Program**
- **Not Recommended for New Designs**

The Intel M2716M and M2716 are 16,384-bit ultraviolet erasable and electrically programmable read only memories (EPROMs) specified over the military extended temperature range respectively. They operate from a single +5V power supply, have a static power-down mode, and feature fast, single-address location programming. It makes designing with EPROMs faster, easier and more economical. Both products are manufactured from the same dice. Except for the operating temperature range, both products have the same electrical and programming specifications.

The M2716/M2716M has a static standby mode which reduces the power dissipation without increasing access time. The active power dissipation is reduced by over 60% in the standby power mode. Both are pin compatible to Intel's 32K military EPROM, the M2732A.

The M2716/M2716M has the simplest and fastest method devised yet for programming EPROMs—single pulse TTL level programming. No need for high voltage pulsing because all programming controls are handled by TTL signals. Program any location at any time—either individually, sequentially or at random, with the M2716's single-address location programming. Total programming time for all 16,384 bits is only 100 seconds.

Block Diagram

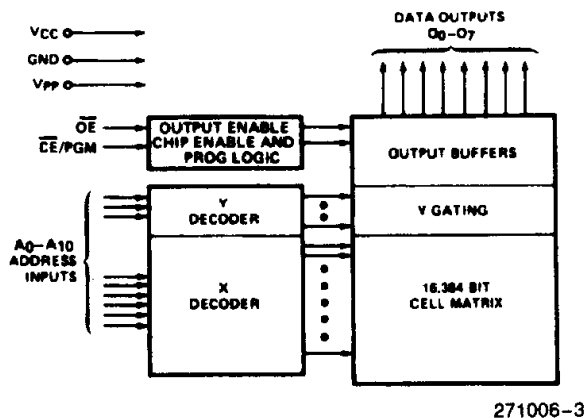

Pin Configurations

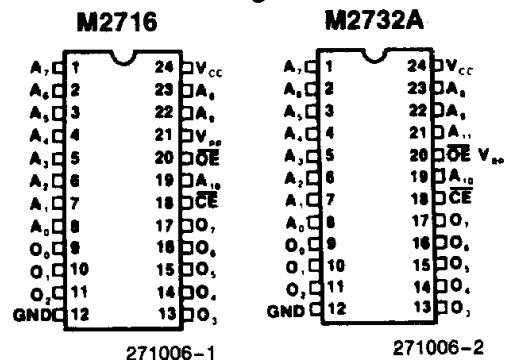

Mode Selection

Mode	Pins	CE/PGM (18)	OE (20)	V _{pp} (21)	V _{CC} (24)	Outputs (9-11, 13-17)
Read		V _{IL}	V _{IL}	+5	+5	D _{OUT}
Standby		V _{IH}	Don't Care	+5	+5	High Z
Program		Pulsed V _{IL} to V _{IH}	V _{IH}	+25	+5	D _{IN}
Program Verify		V _{IL}	V _{IL}	+25	+5	D _{OUT}
Program Inhibit		V _{IL}	V _{IH}	+25	+5	High Z

Pin Names

A ₀ -A ₁₀	Addresses
CE/PGM	Chip Enable/Program
OE	Output Enable
O ₀ -O ₇	Outputs



ABSOLUTE MAXIMUM RATINGS*

Case Temperature Under Bias . . . -65°C to +135°C
 Storage Temperature -65°C to +150°C
 All Input or Output Voltages with Respect to Ground +6V to -0.3V
 V_{PP} Supply Voltage with Respect to Ground During Program +26.5V to -0.3V

NOTICE: This is a production data sheet. The specifications are subject to change without notice.

**WARNING: Stressing the device beyond the "Absolute Maximum Ratings" may cause permanent damage. These are stress ratings only. Operation beyond the "Operating Conditions" is not recommended and extended exposure beyond the "Operating Conditions" may affect device reliability.*

D.C. AND A.C. OPERATING CONDITIONS

	Case Temperature (Instant On)	V _{CC}	V _{PP}
M2716M	-55°C to +125°C	5V ± 10%	V _{CC}
M2716	-55°C to +100°C	5V ± 10%	V _{CC}

D.C. CHARACTERISTICS

Symbol	Parameter	Limits			Units	Comments
		Min	Typ ⁽³⁾	Max		
I _{LI}	Input Load Current			10	μA	V _{IN} = 5.5V
I _{LO}	Output Leakage Current			10	μA	V _{OUT} = 5.5V
I _{PP1} ⁽²⁾	V _{PP} Current			6	mA	V _{PP} = 5.5V
I _{CC1} ⁽²⁾	V _{CC} Current (Standby)		10	30	mA	$\overline{CE} = V_{IH}, \overline{OE} = V_{IL}$
I _{CC2} ⁽²⁾	V _{CC} Current (Active)		57	115	mA	$\overline{OE} = \overline{CE} = V_{IL}$
V _{IL}	Input Low Voltage	-0.1		0.8	V	
V _{IH}	Input High Voltage	2.0		V _{CC} + 1	V	
V _{OL}	Output Low Voltage			0.45	V	I _{OL} = 2.1 mA
V _{OH}	Output High Voltage	2.4			V	I _{OH} = -400 μA

NOTES:

- V_{CC} must be applied simultaneously or before V_{PP} and removed simultaneously or after V_{PP}.
- V_{PP} can be connected directly to V_{CC} except during programming. The supply current will then be the sum of I_{CC} and I_{PP1}.
- Typical values are for T_C = 25°C and nominal supply voltages.

TYPICAL CHARACTERISTICS

I_{CC} Current vs. Temperature

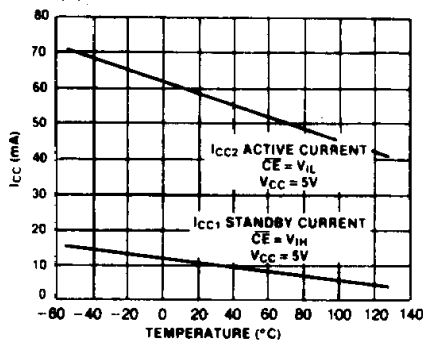

Access Time vs. Capacitance

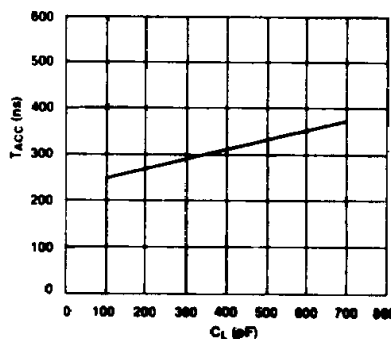

Access Time vs. Temperature

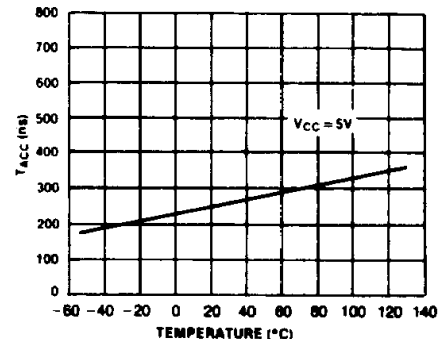

A.C. CHARACTERISTICS

Symbol	Parameter	Limits			Units	Comments
		Min	Typ ⁽³⁾	Max		
t _{ACC}	Address to Output Delay			450	ns	$\overline{CE} = \overline{OE} = V_{IL}$
t _{CE}	\overline{CE} to Output Delay			450	ns	$\overline{OE} = V_{IL}$
t _{OE}	Output Enable to Output Delay			150	ns	$\overline{CE} = V_{IL}$
t _{DF}	Output Enable High to Output Float	0		130	ns	$\overline{CE} = V_{IL}$
t _{OH}	Output Hold from Addresses, \overline{CE} or \overline{OE} Whichever Occurred First	0			ns	$\overline{CE} = \overline{OE} = V_{IL}$

CAPACITANCE T_C = 25°C, f = 1 MHz

Symbol	Parameter	Typ	Max	Units	Conditions
C _{IN}	Input Capacitance	4	6	pF	V _{IN} = 0V
C _{OUT}	Output Capacitance	8	12	pF	V _{OUT} = 0V

A.C. TEST CONDITIONS

Output Load 1 TTL gate and C_L = 100 pF
 Input Rise and Fall Times ≤ 20 ns

Input Pulse Levels 0.8V to 2.2V
 Timing Measurement Reference Level:
 Inputs 1V and 2V
 Outputs 0.8V and 2V

A.C. TESTING, OUTPUT WAVEFORM

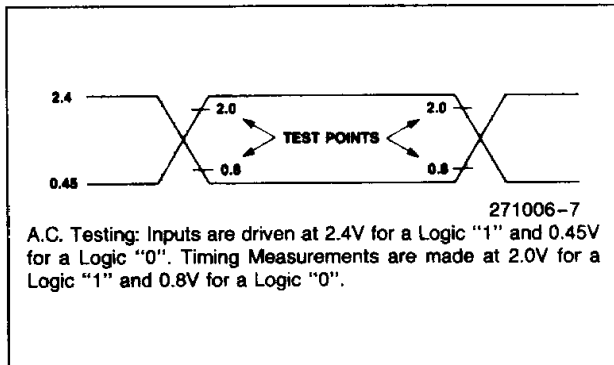

A.C. TESTING LOAD CIRCUIT

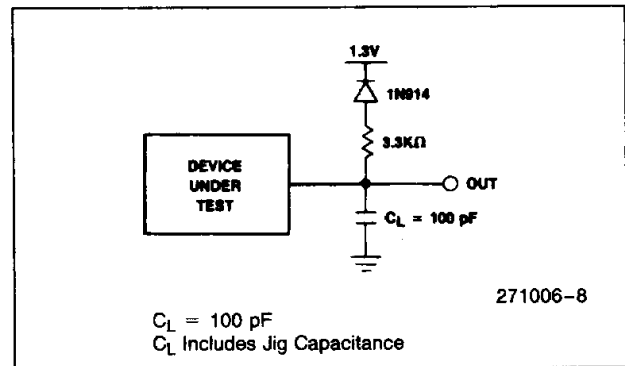

A.C. WAVEFORMS(5)

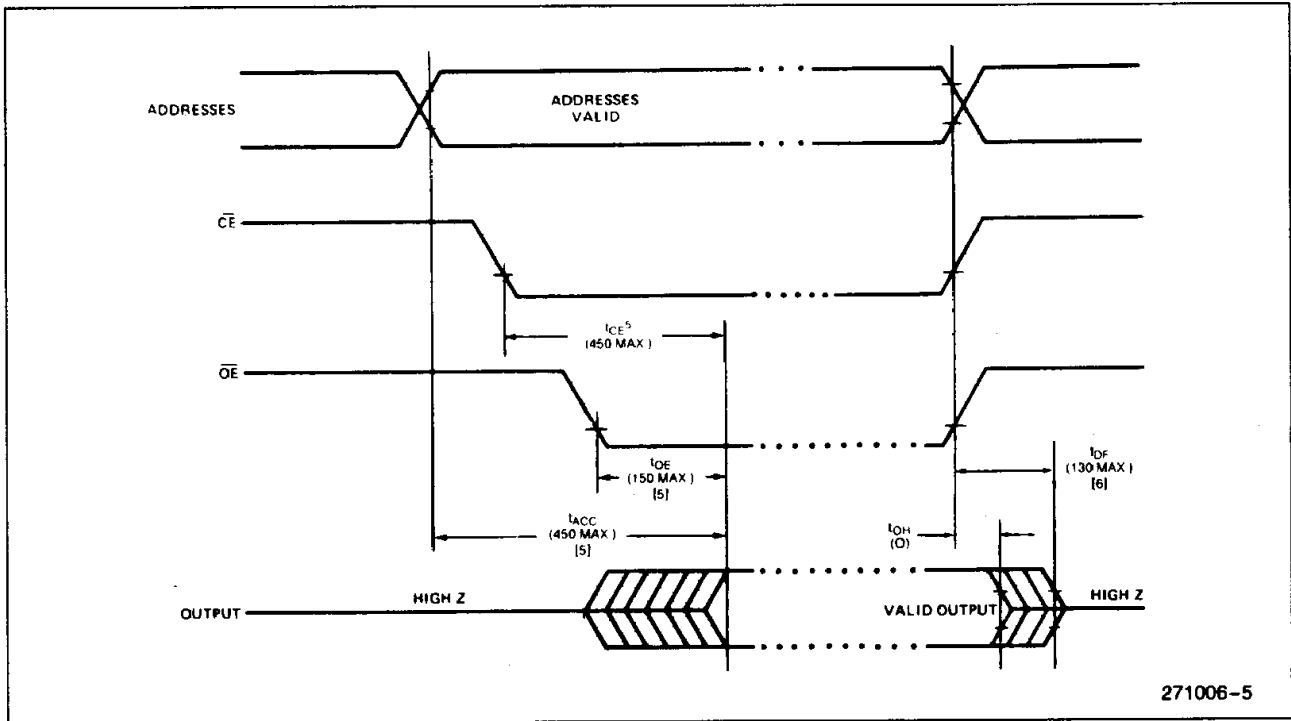

NOTES:

1. V_{CC} must be applied simultaneously or before V_{PP} and removed simultaneously or after V_{PP} .
2. V_{PP} can be connected directly to V_{CC} except during programming. The supply current will then be the sum of I_{CC} and I_{PP1} .
3. Typical values are for $T_C = 25^\circ C$ and nominal supply voltages.
4. All times shown in parentheses are minimum and are nsec unless otherwise specified.
5. \overline{OE} may be delayed up to $t_{ACC} - t_{OE}$ after the falling edge of \overline{CE} without impact on t_{ACC} .
6. Output Float is defined as the point where data is no longer driven.

DEVICE OPERATION

The five modes of operation of the M2716 are listed in Table 1. It should be noted that all inputs for the five modes are at TTL levels. The power supplies required are a +5V V_{CC} and a V_{PP} . The V_{PP} power supply must be at 25V during the three programming modes, and must be at 5V in the other two modes.

Read Mode

The M2716 has two control functions, both of which must be logically satisfied in order to obtain data at the outputs. Chip Enable (CE) is the power control and should be used for device selection. Output Enable (\overline{OE}) is the output control and should be used to gate data to the output pins, independent of de-

Mode Selection

Mode	Pins	\overline{CE}/PGM (18)	\overline{OE} (20)	V_{PP} (21)	V_{CC} (24)	Outputs (9-11, 13-17)
Read		V_{IL}	V_{IL}	+5	+5	D_{OUT}
Standby		V_{IH}	Don't Care	+5	+5	High Z
Program		Pulsed V_{IL} to V_{IH}	V_{IH}	+25	+5	D_{IN}
Program Verify		V_{IL}	V_{IL}	+25	+5	D_{OUT}
Program Inhibit		V_{IL}	V_{IH}	+25	+5	High Z

vice selection. Assuming that addresses are stable, address access time (t_{ACC}) is equal to the delay from \overline{CE} to output (t_{CE}). Data is available at the outputs 150 ns (t_{OE}) after the falling edge of \overline{OE} , assuming that \overline{CE} has been low and addresses have been stable for at least $t_{ACC} - t_{OE}$.

Standby Mode

The M2716 has a standby mode which reduces the active power dissipation by 75%, from 633 mW to 165 mW. The M2716 is placed in the standby mode by applying a TTL high special to the CE input. When in standby mode, the outputs are in a high impedance state, independent of the \overline{OE} input.

Output Or-Tieing

Because M2716's are usually used in larger memory arrays, Intel has provided a 2 line control function that accommodates this use of multiple memory connections. The two line control function allows for

- a) the lowest possible memory power dissipation, and,
- b) complete assurance that output bus contention will not occur.

To most efficiently use these two control lines, it is recommended that \overline{CE} (pin 18) be decoded and used as the primary device selecting function, while \overline{OE} (pin 20) be made a common connection to all devices in the array and connected to the READ line from the system control bus. This assures that all deselected memory devices are in their low power standby mode and that the output pins are only active when data is desired from a particular memory device.

Programming

Initially, and after each erasure, all bits of the M2716 are in the "1" state. Data is introduced by selectively programming "0's" into the desired bit locations. Although only "0's" will be programmed, both "1's" and "0's" can be presented in the data word. The only way to change a "0" to a "1" is by ultraviolet light erasure.

The M2716 is in the programming mode when the V_{PP} power supply is at 25V and \overline{OE} is at V_{IH} . The data to be programmed is applied 8 bits in parallel to the data output pins. The levels required for the address and data inputs are TTL.

When the address and data are stable, a 50 ms, active high, TTL program pulse is applied to the \overline{CE} input. A program pulse must be applied at each address location to be programmed. You can program any location at any time—either individually, sequentially or at random. The program pulse has a maximum width of 55 ms. The M2716 must not be programmed with a DC signal applied to the \overline{CE} input.

Programming of multiple M2716's in parallel with the same data can be easily accomplished due to the simplicity of the programming requirements. Like inputs of the paralleled M2716's may be connected together when they are programmed with the same data. A high level TTL pulse applied to the \overline{CE} input programs the paralleled M2716's.

Program Inhibit

Programming of multiple M2716's in parallel with different data is also easily accomplished. Except for \overline{CE} , all like units (including \overline{OE}) of the parallel M2716's may be common. A TTL level program pulse applied to a M2716's \overline{CE} input with V_{PP} at 25V will program that M2716. A low level \overline{CE} input inhibits the other M2716 from being programmed.

Program Verify

A verify should be performed on the programmed bits to determine that they were correctly programmed. The verify may be performed with V_{PP} at 25V. Except during programming and program verify, V_{PP} must be at 5V.

DEVICE RELIABILITY

The M2716 is built on a proven 2 layer polysilicon NMOS technology. Extensive testing and monitoring has allowed us to achieve failure rates equal to other memory devices.

PROGRAMMING CHARACTERISTICS
D.C. PROGRAMMING CHARACTERISTICS
 $T_C = 25^\circ\text{C} \pm 5^\circ\text{C}$, $V_{CC}^{(1)} = 5\text{V} \pm 5\%$, $V_{PP}^{(1,2)} = 25\text{V} \pm 1\text{V}$

Symbol	Parameter	Min	Typ	Max	Units	Comments
I_{LI}	Input Current (for Any Input)			10	μA	$V_{IN} = 5.25\text{V}$ or 0.45V
I_{PP1}	V_{PP} Supply Current			5	mA	$\overline{CE} = V_{IL}$
I_{PP2}	V_{PP} Supply Current During Programming Pulse			30	mA	$\overline{CE} = V_{IH}$
I_{CC}	V_{CC} Supply Current			100	mA	
V_{IL}	Input Low Level	-0.1		0.8	V	
V_{IH}	Input High Level	2.0		$V_{CC} + 1$	V	

A.C. PROGRAMMING CHARACTERISTICS
 $T_C = 25^\circ\text{C} \pm 5^\circ\text{C}$, $V_{CC}^{(1)} = 5\text{V} \pm 5\%$, $V_{PP}^{(1,2)} = 25\text{V} \pm 1\text{V}$

Symbol	Parameter	Min	Typ	Max	Units	Comments
t_{AS}	Address Setup Time	2			μs	
t_{OES}	\overline{OE} Setup Time	2			μs	
t_{DS}	Data Setup Time	2			μs	
t_{AH}	Address Hold Time	2			μs	
t_{OEH}	\overline{OE} Hold Time	2			μs	
t_{DH}	Data Hold Time	2			μs	
t_{DFP}	Output Enable to Output Float Delay	0		200	ns	$\overline{CE} = V_{IL}$
t_{OE}	Output Enable to Output Delay			200	ns	$\overline{CE} = V_{IL}$
t_{PW}	Program Pulse Width	45	50	55	ms	
t_{PRT}	Program Pulse Rise Time	5			ns	
t_{PFT}	Program Pulse Fall Time	5			ns	

A.C. CONDITIONS OF TEST

Input Rise and Fall Times (10% to 90%) 20 ns
 Input Pulse Levels 0.8 to 2.2V
 Input Timing Reference Level 0.8V and 2V
 Output Timing Reference Level 0.8V and 2V

NOTES:

- V_{CC} must be applied simultaneously or before V_{PP} and removed simultaneously or after V_{PP} . The M2716 must not be inserted into or removed from a board with V_{PP} at $25 \pm 1\text{V}$ to prevent damage to the device.
- The maximum allowable voltage which may be applied to the V_{PP} pin during programming is +26V. Care must be taken when switching the V_{PP} supply to prevent overshoot exceeding this 26V maximum specification.

PROGRAMMING WAVEFORMS

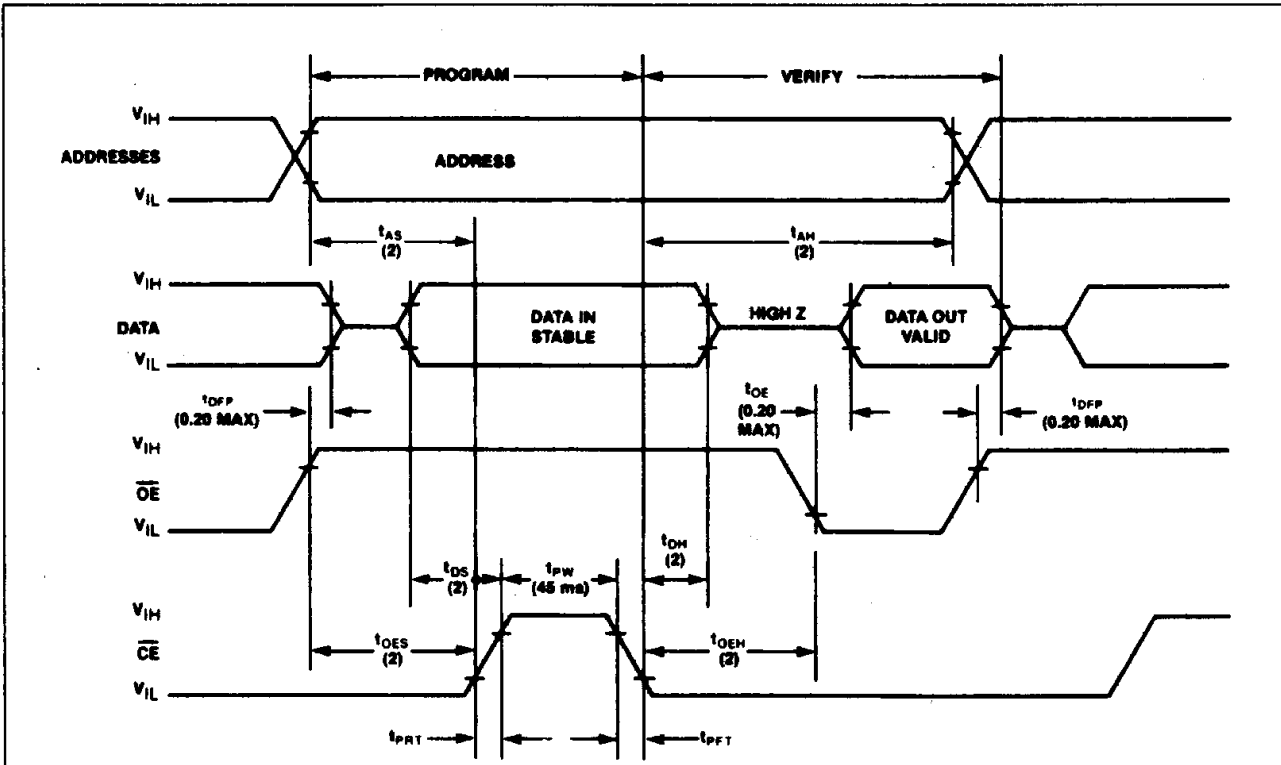

271006-6

NOTES:

1. All times shown in parenthesis are minimum times and are μ s unless otherwise noted.
2. t_{OE} and t_{DFF} are characteristics of the device but must be accommodated by the programmer.