

# KA8301

## Bi-Directional DC Motor Driver

### Features

- Built-in brake function.
- Built-in element to absorb a surge current derived from changing motor direction and braking motor drive.
- External motor speed control pin
- Motor direction change circuit.
- Interfaces with CMOS devices.

### Description

The KA8301 is a monolithic integrated circuit designed for driving bi-directional DC motor with braking and speed control, and it is suitable for the loading motor driver of VCR systems. The speed control can be achieved by adjusting the external voltage of the speed control pin.

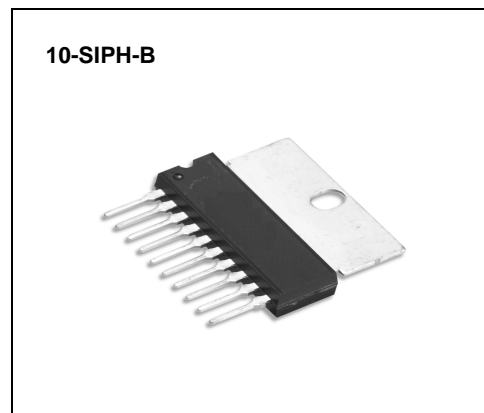

### Typical Application

- Video cassette recorder (VCR) loading motor
- Low current DC motor such audio or video equipment
- General DC motor

### Ordering Information

Device	Package	Operating Temp.
KA8301-L	10-SIPH-B	-25°C ~ +75°C

## Pin Assignments

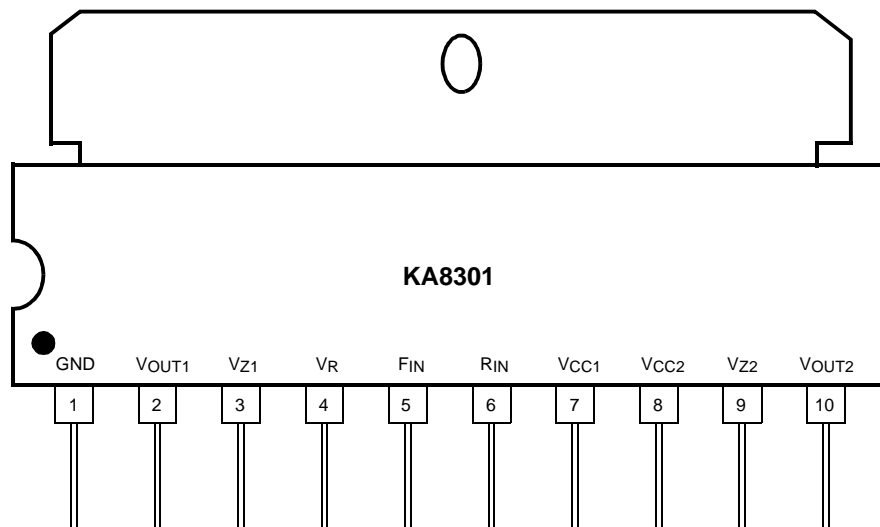

## Pin Definitions

Pin Number	Pin Name	I/O	Pin Function Description
1	GND	-	Ground
2	VOUT1	O	Output 1
3	VZ1	-	Phase compensation
4	VR	I	Motor speed control
5	FIN	I	Input 1
6	RIN	I	Input 2
7	VCC1	-	Supply voltage (Signal)
8	VCC2	I	Supply voltage (Power)
9	VZ2	I	Phase compensation
10	VOUT2	O	Output 2

# Internal Block Diagram

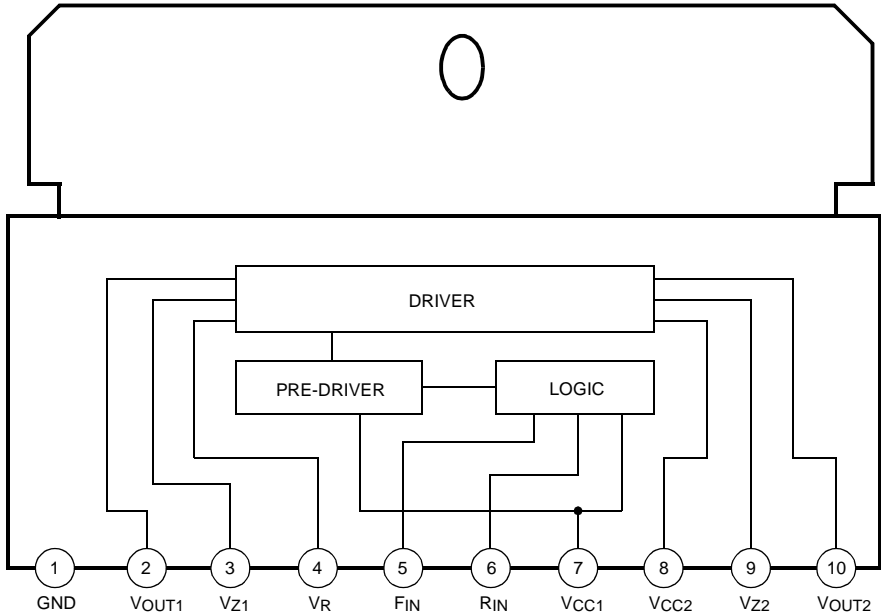

## Equivalent Circuits

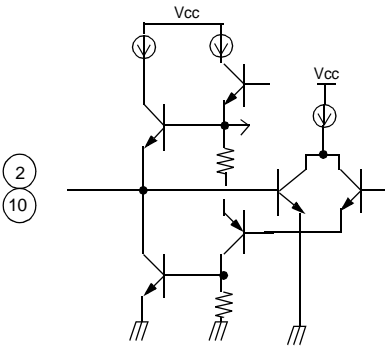
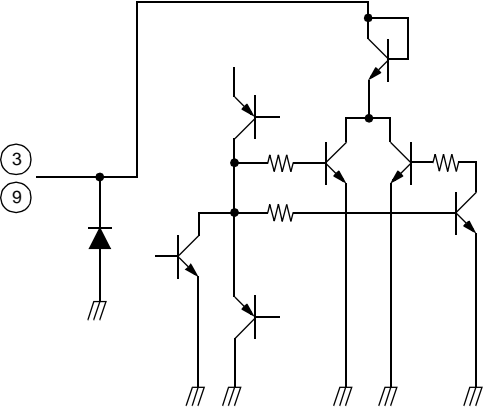
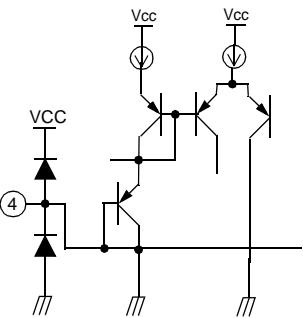
Description	Pin No.	Internal circuit
Output	2, 10	
Phase compensation	3, 9	
Speed control	4	

## Equivalent Circuit (Continued)

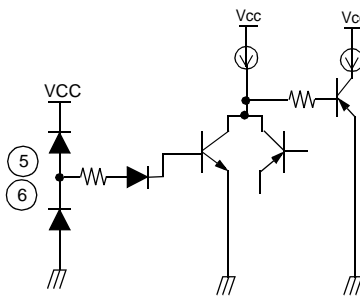
Description	Pin No.	Internal circuit
Input	5, 6	
VCC1	7	
VCC2	8	
GND	1	

## Absolute Maximum Ratings (Ta=25°C)

Parameter	Symbol	Value	Unit
Supply voltage	VCCmax	18	V
Maximum output current	I <sub>Omax</sub>	1.6 <sup>note1</sup>	A
Power dissipation	P <sub>d</sub>	15 <sup>note2</sup>	W
Input voltage	V <sub>IN</sub>	-0.3 ~ VCC	V
Operating temperature	T <sub>OPR</sub>	-25 ~ +75	°C
Storage temperature	T <sub>STG</sub>	-55 ~ +150	°C

### Notes:

- Duty 1/100, pulse width 500μs
- 1) When mounted on glass epoxy PCB (76.2 × 114 × 1.57mm)  
2) Power dissipation reduces 120mW / °C for using above Ta=25°C  
3) Do not exceed P<sub>d</sub> and SOA(Safe Operating Area).

## Power Dissipation Curve

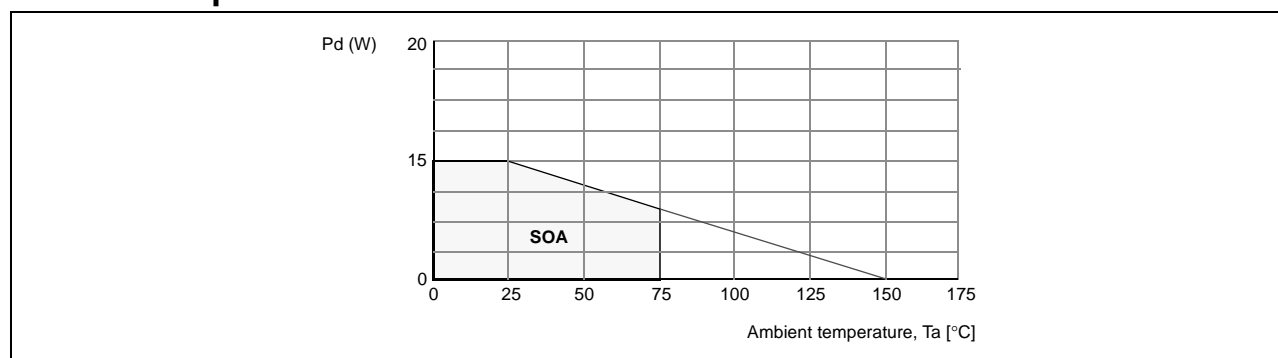

## Recommended Operating Conditions (Ta=25°C)

Parameter	Symbol	Value	Unit
Operating supply voltage	VCC	8 ~ 18	V

## Electrical Characteristics (Ta=25°C, Vcc=12V)

Parameter	Symbol	Conditions	Min.	Typ.	Max.	Units
Quiescent current	I <sub>Q</sub>	Pin5 & 6: GND, R <sub>L</sub> =∞	3	5.5	20	mA
Min. input-on current 1	I <sub>IN1</sub>	R <sub>L</sub> =∞, pin5=I <sub>IN1</sub> , pin6=L	-	10	50	μA
Min. input-on current 2	I <sub>IN2</sub>	R <sub>L</sub> =∞, pin5=L, pin6=I <sub>IN2</sub>	-	10	50	μA
Input threshold voltage 1	V <sub>INTH1</sub>	R <sub>L</sub> =∞, pin5=V <sub>INTH1</sub> , pin6=L	0.7	1.3	2.0	V
Input threshold voltage 2	V <sub>INTH2</sub>	R <sub>L</sub> =∞, pin5=L, pin6=V <sub>INTH2</sub>	0.7	1.3	2.0	V
Output leakage current 1	I <sub>OL1</sub>	R <sub>L</sub> =∞, pin5 & 6=GND	-	-	1	mA
Output leakage current 2	I <sub>OL2</sub>	R <sub>L</sub> =∞, pin5 & 6=GND	-	-	1	mA
Zener current 1	I <sub>Z1</sub>	R <sub>L</sub> =∞, pin5=H, pin6=L	-	0.85	1.5	mA
Zener current 2	I <sub>Z2</sub>	R <sub>L</sub> =∞, pin5=L, pin6=H	-	0.85	1.5	mA
Output voltage 1	V <sub>O1</sub>	R <sub>L</sub> =60Ω, pin5=H, pin6=L	6.6	7.2	-	V
Output voltage 2	V <sub>O2</sub>	R <sub>L</sub> =60Ω, pin5=L, pin6=H	6.6	7.1	-	V
Saturation voltage (Pin10-1)	V <sub>CE10-1</sub>	R <sub>L</sub> =R <sub>C</sub> =∞, pin5=H, pin6=L, I <sub>SINK</sub> =100mA	-	0.83	1.5	V
Saturation voltage (Pin2-1)	V <sub>CE2-1</sub>	R <sub>L</sub> =R <sub>C</sub> =∞, pin5=L, pin6=H, I <sub>SINK</sub> =100mA	-	0.83	1.5	V
Saturation voltage (Pin8-2)	V <sub>CE8-2</sub>	R <sub>L</sub> =R <sub>C</sub> =∞, pin5=H, pin6=L, I <sub>SOURCE</sub> =100mA	-	0.83	1.5	V
Saturation voltage (Pin8-10)	V <sub>CE8-10</sub>	R <sub>L</sub> =R <sub>C</sub> =∞, pin5=L, pin6=H, I <sub>SOURCE</sub> =100mA	-	0.83	1.5	V

## Application Information

### 1. FORWARD AND REVERSE CONTROL LOGIC

Pin #5	Pin #6	Pin #2	Pin #10	Function
L (0.7V ↓)	L (0.7V ↓)	L	L	Brake
L (0.7V ↓)	H (2.0V ↑)	L	H	Reverse
H (2.0V ↑)	L (0.7V ↓)	H	L	Forward
H (2.0V ↑)	H (2.0V ↑)	H	H	Brake

- If pin #5=H, pin #6=L, load current flows from pin #2 to pin #10 through a motor.
- If pin #5=L, pin #6=H, load current flows from pin #10 to pin #2 through a motor.
- If pin #5=pin #6=L or pin #5=pin #6=H, the KA8301 stops supplying the power to motor while absorbing counter EMF from the motor as a brake.

### 2. RUSH CURRENT RESTRICTING CIRCUIT

If a high voltage generated during reversing operation is applied across pin #2 and pin #10, an internal comparator activates the rush current restricting circuit.

### 3. DRIVE CIRCUIT

In the forward mode, the drive circuit supplies a load current to the motor from pin #2 to pin #10.  
In the reverse mode, it supplies the current from pin #10 to pin #2.

The output voltage ( $V_{OUT}$ ) applied to the motor is given by the followings;

$V_{OUT} = V_{ZD} - V_{CE(sat)}$ , where  $V_{ZD}$ : a zener voltage applied to pin #4

If pin #4 is left open, the output voltage is given by the followings;

$V_{OUT} = V_{CC1} - V_{CE(sat, pnp)} - 2V_F - V_{CE(sat)}$



# Typical Performance Characteristics

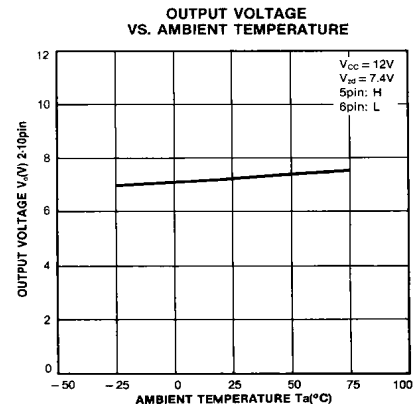
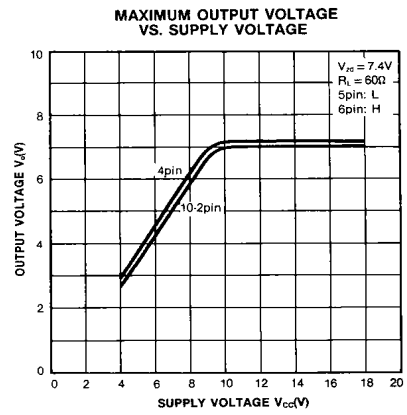
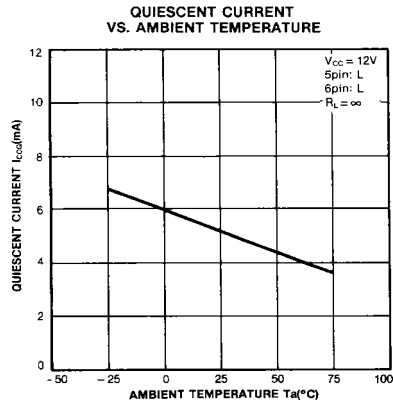
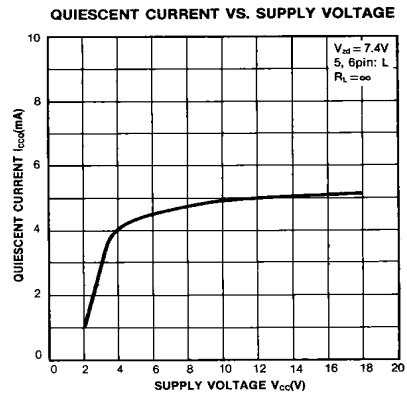
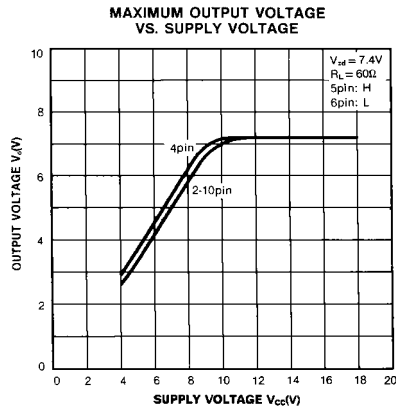

# Typical Performance Characteristics (Continued)

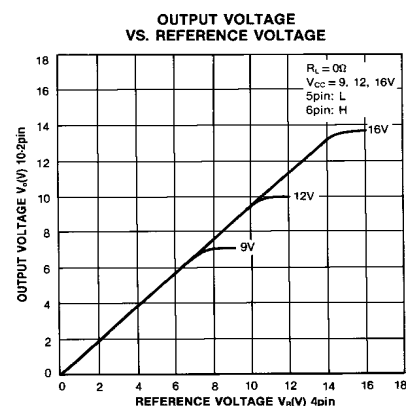
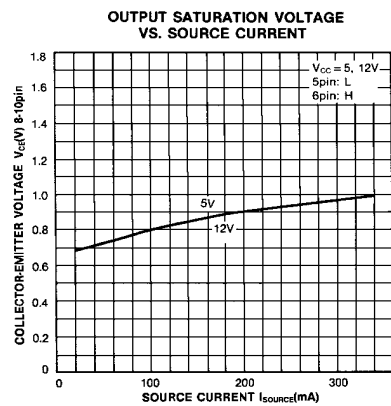
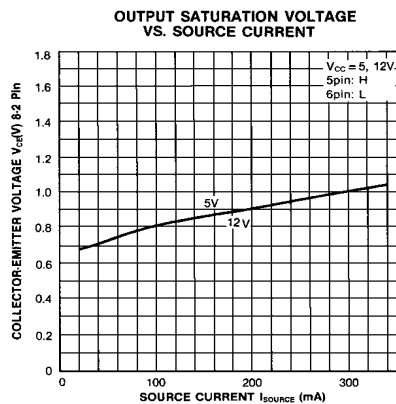
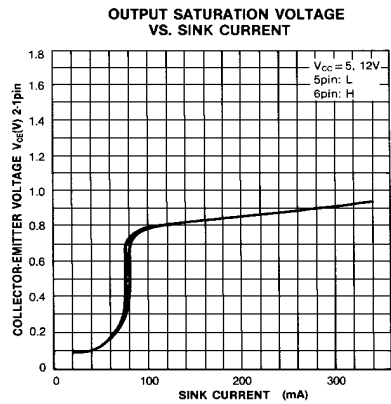
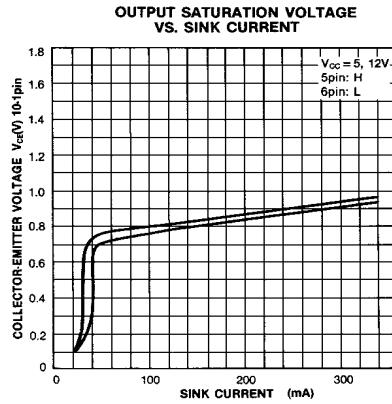
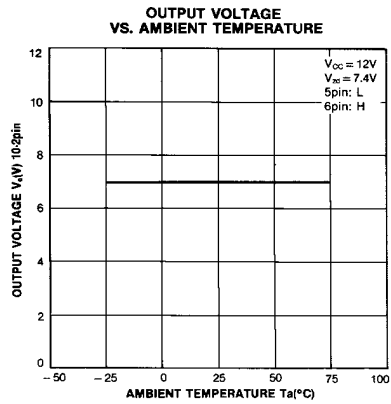

## Typical Performance Characteristics (Continued)

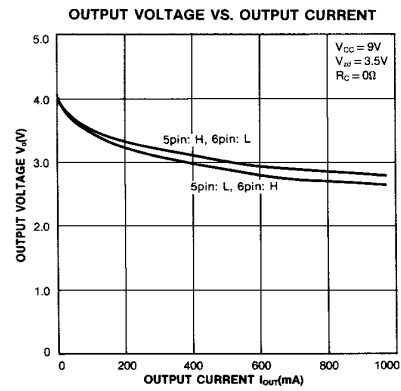
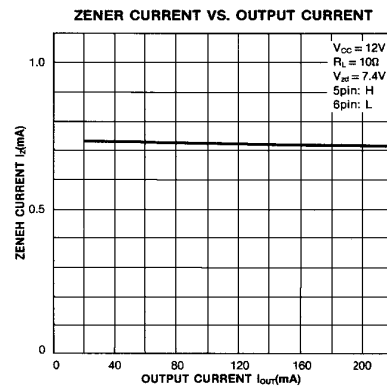
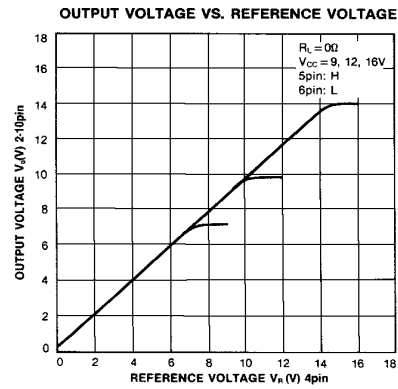

## Test Circuits

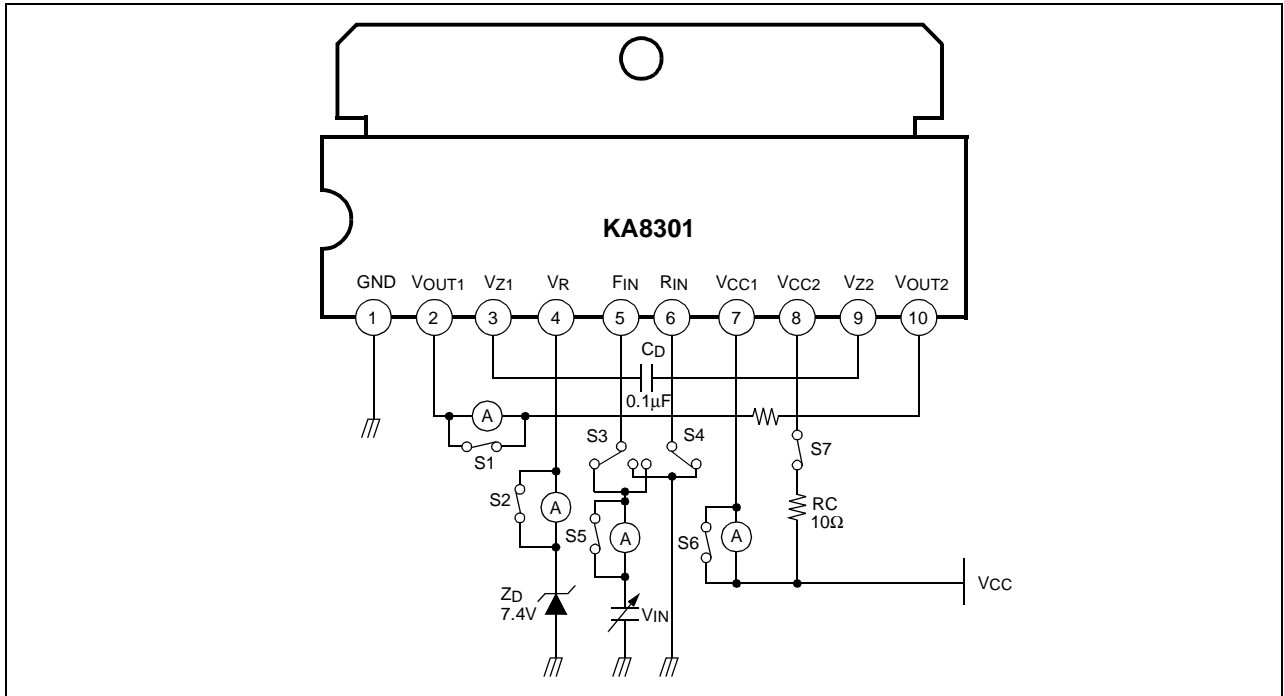

## Typical Application Circuits

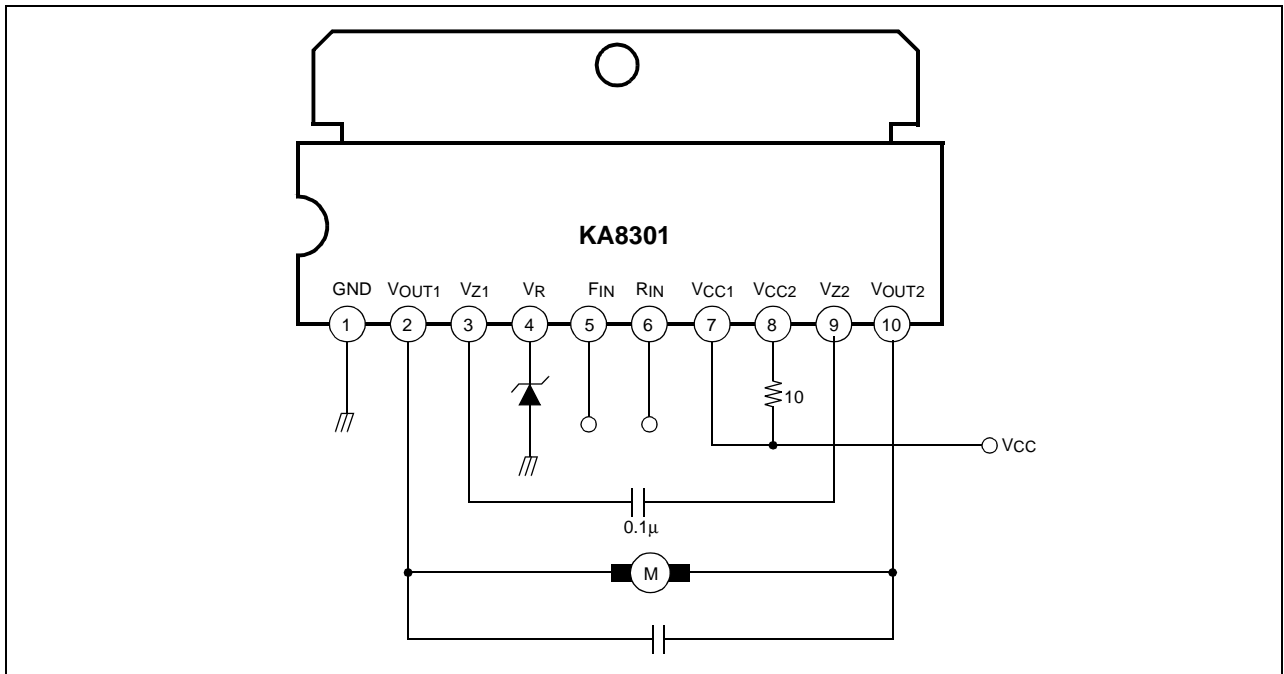

**DISCLAIMER**

FAIRCHILD SEMICONDUCTOR RESERVES THE RIGHT TO MAKE CHANGES WITHOUT FURTHER NOTICE TO ANY PRODUCTS HEREIN TO IMPROVE RELIABILITY, FUNCTION OR DESIGN. FAIRCHILD DOES NOT ASSUME ANY LIABILITY ARISING OUT OF THE APPLICATION OR USE OF ANY PRODUCT OR CIRCUIT DESCRIBED HEREIN; NEITHER DOES IT CONVEY ANY LICENSE UNDER ITS PATENT RIGHTS, NOR THE RIGHTS OF OTHERS.

**LIFE SUPPORT POLICY**

FAIRCHILD'S PRODUCTS ARE NOT AUTHORIZED FOR USE AS CRITICAL COMPONENTS IN LIFE SUPPORT DEVICES OR SYSTEMS WITHOUT THE EXPRESS WRITTEN APPROVAL OF THE PRESIDENT OF FAIRCHILD SEMICONDUCTOR INTERNATIONAL. As used herein:

1. Life support devices or systems are devices or systems which, (a) are intended for surgical implant into the body, or (b) support or sustain life, and (c) whose failure to perform when properly used in accordance with instructions for use provided in the labeling, can be reasonably expected to result in a significant injury of the user.
2. A critical component in any component of a life support device or system whose failure to perform can be reasonably expected to cause the failure of the life support device or system, or to affect its safety or effectiveness.