



## Security & Chip Card ICs

my-d products for contactless systems

my-d vicinity

### SRF 55V02P

Intelligent 2-KBit EEPROM

with Contactless Interface complying to ISO/IEC 15693

and Security Logic

Plain Mode Operation

**Revision History: Current Version 2002-07-30**

Previous Releases: 2001-08-15

Page	Subjects (changes since last revision)
	Editorial changes

**Important:** Further information is confidential and on request. Please contact:  
Infineon Technologies AG in Munich, Germany,  
Security & Chip Card ICs,  
Tel +49 (0)89 / 234-80000  
Fax +49 (0)89 / 234-81000  
E-Mail: security.chipcard.ics@infineon.com

**Published by Infineon Technologies AG, CC Applications Group**

**St.-Martin-Strasse 53, D-81541 München**

**© Infineon Technologies AG 2002**

**All Rights Reserved.**

#### **To our valued customers**

We constantly strive to improve the quality of all our products and documentation. We have spent an exceptional amount of time to ensure that this document is correct. However, we realise that we may have missed a few things. If you find any information that is missing or appears in error, please use the contact section above to inform us. We appreciate your assistance in making this a better document.

#### **Attention please!**

The information herein is given to describe certain components and shall not be considered as warranted characteristics.

Terms of delivery and rights to technical change reserved.

We hereby disclaim any and all warranties, including but not limited to warranties of non-infringement, regarding circuits, descriptions and charts stated herein.

Infineon Technologies is an approved CECC manufacturer.

#### **Information**

For further information on technology, delivery terms and conditions and prices please contact your nearest Infineon Technologies Office in Germany or our Infineon Technologies Representatives world-wide (see address list).

#### **Warnings**

Due to technical requirements components may contain dangerous substances. For information on the types in question please contact your nearest Infineon Technologies Office.

Infineon Technologies Components may only be used in life-support devices or systems with the express written approval of Infineon Technologies, if a failure of such components can reasonably be expected to cause the failure of that life-support device or system, or to affect the safety or effectiveness of that device or system. Life support devices or systems are intended to be implanted in the human body, or to support and/or maintain and sustain and/or protect human life. If they fail, it is reasonable to assume that the health of the user or other persons may be endangered.

## Intelligent 2-KBit EEPROM with Contactless Interface complying to ISO/IEC 15693 and Security Logic

### my-d vicinity – Plain Mode Operation

#### Features

- **2-KBit EEPROM**
  - Organised in 32 pages located in 1 sector
  - Each page organised in 8 bytes for data storage + 2 bytes for administrative purposes
  - Configurable number of sectors (1 to 15) & sector size (1 up to 128 pages)
  - Service Area 4 pages
  - User Area 124 pages
  - Unique chip identification number
- **Smart Electronic Article Surveillance (EAS)**
  - Easy Integration in existing infrastructure
  - On/Off EAS switch feature
- **Value Counters: up to 65536 units** (with a value range from 0 to  $2^{16}-1$ )
  - Each page in User Area configurable as a Counter
  - Support of Anti-Tearing
- **Physical Interface and Anticollision complying to ISO/IEC 15693**
  - Carrier frequency: 13.56 MHz
  - up to 26 kbit/s data rate transfer
  - Anticollision method complying with ISO/IEC 15693 with identification of up to 30 tags/sec
  - Contactless transmission of data and supply energy
  - Coupling distance from 0 to 120 cm (typical, dependent on antenna)
- **EEPROM updating (erase and program) time maximum 4 ms per page**
- **EEPROM endurance minimum  $10^5$  write/erase cycles<sup>1)</sup>**
- **Data retention for minimum of 10 years<sup>1)</sup>**
- **ESD protection typical 4 kV**
- **Ambient temperature  $-25 \dots +85^\circ\text{C}$  for chip and MCC,  $-25 \dots +70^\circ\text{C}$  for Inlay**

---

<sup>1)</sup> Values are temperature dependent

## Document References

- Confidential Data Sheet
- Qualification report chip
  
- Chip delivery specification for wafer with chip-layout (die size, orientation, ...)
- Module specification containing description of package, product logistic etc.
- Qualification report module
  
- Inlay specification containing description of package, product logistic etc.
- Qualification report inlay

## Development Tool Overview

- my-d vicinity evaluation and demonstration kit

## 1 Ordering and Packaging information

**Table 1 Ordering Information**

Type	Package <sup>1)</sup>	Memory		Pages	Ordering Code
		User	Admin.		
SRF 55V02P C	Die	256 bytes	64 bytes	32	Q67100H4896
SRF 55V02P MCC8	P-MCC8-2-1				on request
SRF 55V02P Y1.0	Inlay 45 x 45 mm <sup>2</sup>				Q67100H4909
SRF 55V02P Y2.0	Inlay 45 x 76 mm <sup>2</sup>				Q67100H4908

<sup>1)</sup> Available as a die (C) for customer packaging, as inlay (Y) or as a Module Contactless Card (MCC) for embedding in plastic cards

### Pin Description

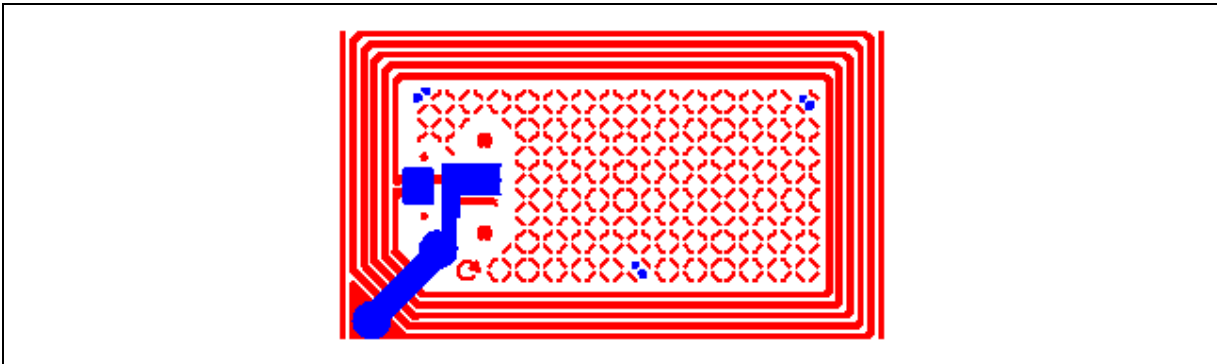

Figure 1 Pin Configuration Label Inlay (top view)

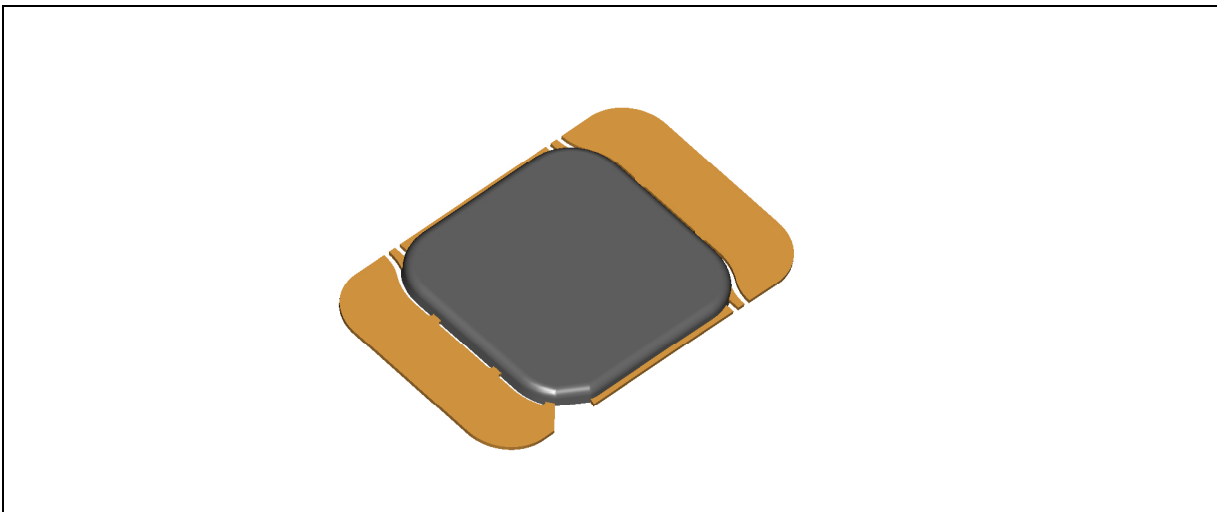

Figure 2 Pin Configuration Module Contactless Card (top view)

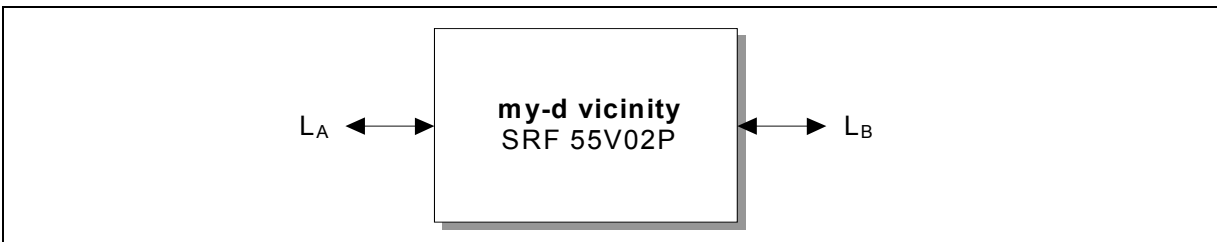

Figure 3 Pad Configuration Die

Table 2 Pin Definitions and Functions

Symbol	Function
L <sub>A</sub>	Antenna connection
L <sub>B</sub>	Antenna connection

## 2 my-d products for contactless systems

my-d products for contactless systems are designed to meet the increased security and flexibility demand of the market. This family of contactless memories supports the different interface and memory size needs as well as various security requirements for variable applications.

The product series functional architecture (e.g. memory organisation, authentication) is the same for both proximity (ISO/IEC 14443) and vicinity (ISO/IEC 15693). This eases the system design and allows simple adaptation of applications from my-d proximity to my-d vicinity or vice versa.

Applications are supported very flexible by setting the appropriate mode for the my-d product, starting with plain mode with a page locking mechanism up to various settings in secure mode for multi user / multi application configurations with tearing protected counters. In secure mode a strong cryptographic algorithm with 64 bit key length is additionally available for security mechanisms like mutual authentication and message authentication codes.

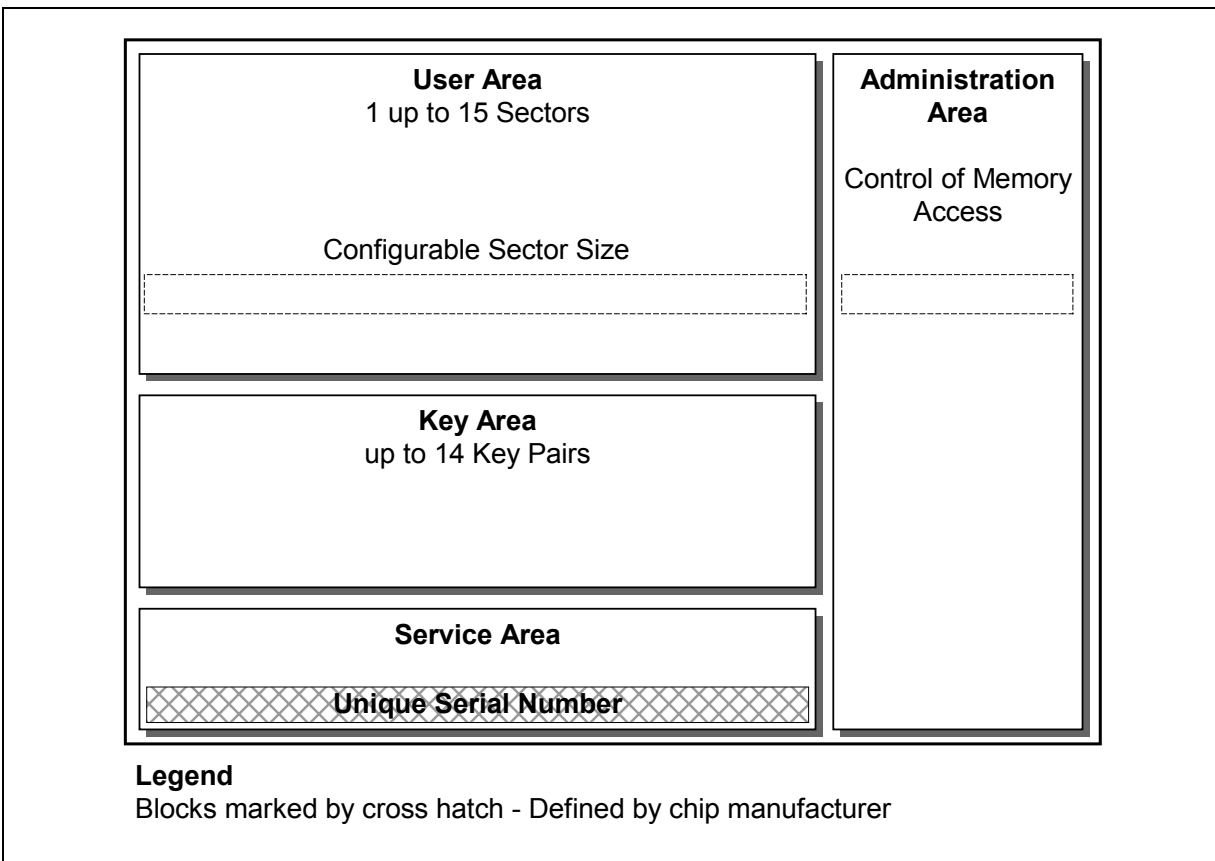

**Figure 4 Memory principle of my-d products**

These powerful features make the contactless security memory product series my-d ready to cope with even high-end requirements. Architectural compatibility of all my-d products allow an easy migration path from simple to powerful demanding applications.

### **3 my-d vicinity products**

my-d vicinity focuses on flexible memory and sector configuration with higher read/write distances. This family of contactless memory chips supplies the user with different memory sizes and optionally offers the use of security features meeting the requirements of variable applications. As special feature the EAS (Electronic Article Surveillance) mode is built in to achieve higher and more robust performance in the demanding EAS application.

my-d vicinity products are available in two memory sizes as well as in plain mode and in secure mode:

- my-d vicinity plain mode with plain memory allowing unlimited access (SRF 55VxxP). Thus the memory is organised in one sector.
- my-d vicinity secure mode allowing to configure counters and to secure memory access by authentication measures (SRF 55VxxS). Thus the memory may be organised in up to 16 sectors with at least one sector in plain mode.
- 2,5 KBit memory sizes 32 pages with 10 Bytes (8 byte user data)
- 10 KBit memory sizes 128 pages with 10 Bytes (8 byte user data)
- In security mode advanced functions are available. Please refer to the relevant data book for details.

All my-d vicinity products comply to the standard ISO/IEC 15693 for contactless vicinity smart cards. The power supply and data are transferred to my-d products via an antenna. my-d vicinity is designed to communicate up to a typical operating distance of 120 cm with a contactless reader in an appropriate gate configuration.

### 3.1 Circuit Description

my-d vicinity consists of a EEPROM memory unit, an analog interface for contactless energy and data transmission and a control unit.

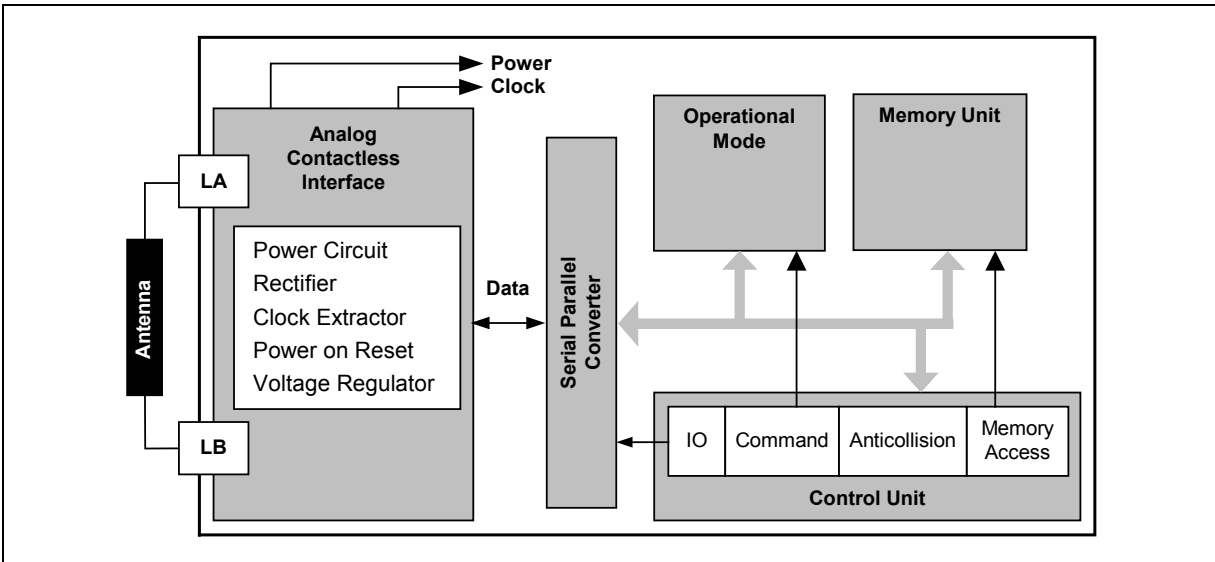

Figure 5 Block diagram of my-d vicinity

- **Analog Contactless Interface consists of:**
  - Rectifier
  - Voltage Regulator
  - Power on Reset
  - Modulator / Demodulator
  - Clock Extractor
- **Operational mode**  
The memory is accessed according to plain mode when the VICC is selected.
- **Memory Unit**  
320 bytes organised in 32 pages with 8 + 2 bytes each.
- **Control Unit**
  - Decoding and execution of the **commands**
  - **Anticollision** method complying to ISO/IEC 15693. It allows the recognition of several labels in the field which may be selected and operated in sequence.
  - **Memory access** to the pages according to the individual access conditions programmed for every page and every key



### 3.2 System Overview

The system consists of a contactless label on one hand and a contactless reader together with an antenna on the other.

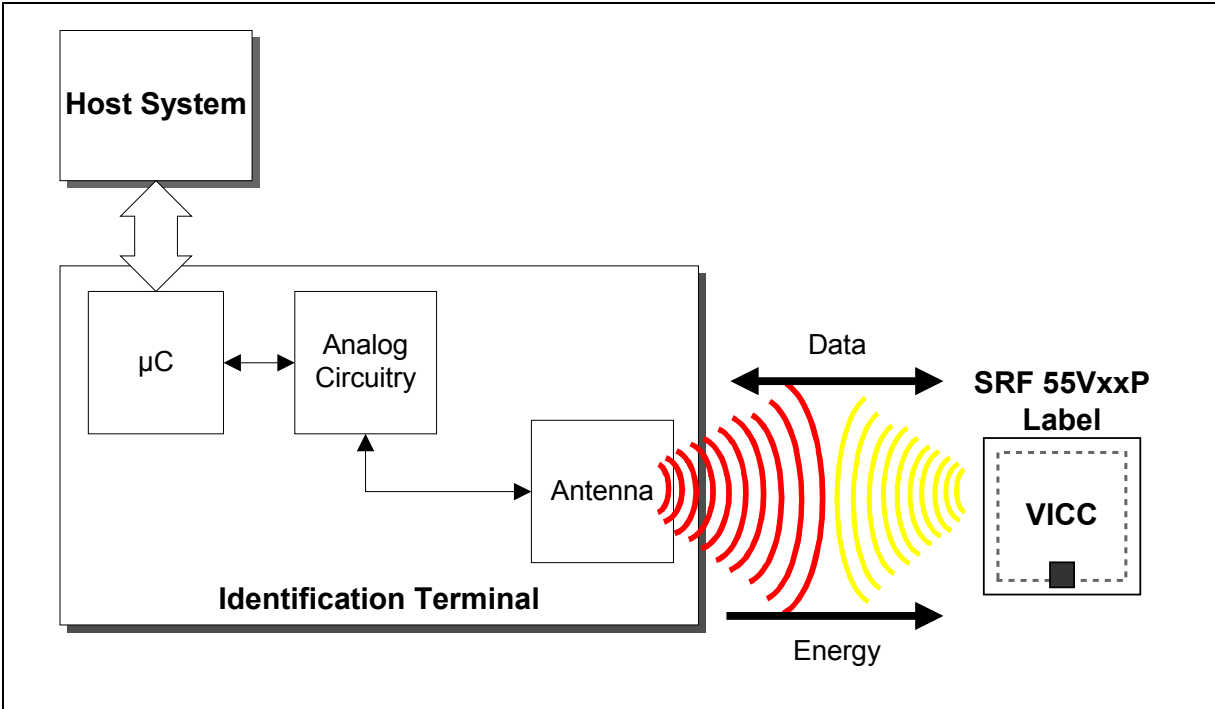

**Figure 6 Contactless System Example**

- VICC – Vicinity Card according to ISO/IEC 15693

#### Contactless Energy and Data Transfer

The operating distance between label and reader antenna is typically up to 120 cm in an appropriate gate configuration. The label antenna consists of a simple coil with a few turns. Contactless labels are passive. The RF communication interface allows to exchange data with 26 kbit/s. This high data transmission rate permits short transaction times.

An intelligent anticollision function allows to operate more than one label in the field simultaneously. The anticollision algorithm selects each label individually and ensures that the execution of a transaction with a selected label is performed correctly without data corruption resulting from other labels.

#### System Security

The serial number is unique for each label and can not be changed.