

DDR2 Unbuffered SODIMM

**200pin Unbuffered SODIMM based on 512Mb B-die
64bit Non-ECC**

**INFORMATION IN THIS DOCUMENT IS PROVIDED IN RELATION TO SAMSUNG PRODUCTS,
AND IS SUBJECT TO CHANGE WITHOUT NOTICE.**

**NOTHING IN THIS DOCUMENT SHALL BE CONSTRUED AS GRANTING ANY LICENSE,
EXPRESS OR IMPLIED, BY ESTOPPEL OR OTHERWISE,**

**TO ANY INTELLECTUAL PROPERTY RIGHTS IN SAMSUNG PRODUCTS OR TECHNOLOGY. ALL
INFORMATION IN THIS DOCUMENT IS PROVIDED**

ON AS "AS IS" BASIS WITHOUT GUARANTEE OR WARRANTY OF ANY KIND.

1. For updates or additional information about Samsung products, contact your nearest Samsung office.
2. Samsung products are not intended for use in life support, critical care, medical, safety equipment, or similar applications where Product failure could result in loss of life or personal or physical harm, or any military or defense application, or any governmental procurement to which special terms or provisions may apply.

* Samsung Electronics reserves the right to change products or specification without notice.

DDR2 Unbuffered SODIMM Ordering Information

Part Number	Density	Organization	Component Composition	Number of Rank	Height
M470T3354BG(Z)3-CD5/CC	256MB	32Mx64	32Mx16(K4T51163QB)*4	1	30mm
M470T3354BG(Z)0-CD5/CC	256MB	32Mx64	32Mx16(K4T51163QB)*4	1	30mm
M470T3354BZ3-LD5/CC	256MB	32Mx64	32Mx16(K4T51163QB)*4	1	30mm
M470T3354BZ0-LD5/CC	256MB	32Mx64	32Mx16(K4T51163QB)*4	1	30mm
M470T6554BG(Z)3-CD5/CC	512MB	64Mx64	32Mx16(K4T51163QB)*8	2	30mm
M470T6554BG(Z)0-CD5/CC	512MB	64Mx64	32Mx16(K4T51163QB)*8	2	30mm
M470T6554BZ3-LD5/CC	512MB	64Mx64	32Mx16(K4T51163QB)*8	2	30mm
M470T6554BZ0-LD5/CC	512MB	64Mx64	32Mx16(K4T51163QB)*8	2	30mm
M470T2953BS(Y)3-CD5/CC	1GB	128Mx64	64Mx8(K4T51083QB)*16	2	30mm
M470T2953BS(Y)0-CD5/CC	1GB	128Mx64	64Mx8(K4T51083QB)*16	2	30mm
M470T2953BY3-LD5/CC	1GB	128Mx64	64Mx8(K4T51083QB)*16	2	30mm
M470T2953BY0-LD5/CC	1GB	128Mx64	64Mx8(K4T51083QB)*16	2	30mm

Note: "Z" and "Y" of Part number(11th digit) stand for Lead-free products.

Note: "3" of Part number(12th digit) stand for Dummy Pad PCB products.

Features

- Performance range

	D5(DDR2-533)	CC(DDR2-400)	Unit
Speed@CL3	400	400	Mbps
Speed@CL4	533	400	Mbps
CL-tRCD-tRP	4-4-4	3-3-3	CK

- JEDEC standard 1.8V ± 0.1V Power Supply
- $V_{DDQ} = 1.8V \pm 0.1V$
- 200 MHz f_{CK} for 400Mb/sec/pin, 267MHz f_{CK} for 533Mb/sec/pin
- 4 Banks
- Posted \overline{CAS}
- Programmable \overline{CAS} Latency: 3, 4, 5
- Programmable Additive Latency: 0, 1, 2, 3 and 4
- Write Latency(WL) = Read Latency(RL) - 1
- Burst Length: 4, 8(Interleave/nibble sequential)
- Programmable Sequential / Interleave Burst Mode
- Bi-directional Differential Data-Strobe (Single-ended data-strobe is an optional feature)
- Off-Chip Driver(OCD) Impedance Adjustment
- On Die Termination
- Average Refresh Period 7.8us at lower than a $T_{CASE} 85^{\circ}C$, 3.9us at $85^{\circ}C < T_{CASE} \leq 95^{\circ}C$
 - support High Temperature Self-Refresh rate enable feature
- Package: 60ball FBGA - 64Mx8, 84ball FBGA - 32Mx16
- All of Lead-free products are compliant for RoHS

Note: For detailed DDR2 SDRAM operation, please refer to Samsung's Device operation & Timing diagram.

Address Configuration

Organization	Row Address	Column Address	Bank Address	Auto Precharge
64Mx8(512Mb) based Module	A0-A13	A0-A9	BA0-BA1	A10
32Mx16(512Mb) based Module	A0-A12	A0-A9	BA0-BA1	A10

Pin Configurations (Front side/Back side)

Pin	Front	Pin	Back	Pin	Front	Pin	Back	Pin	Front	Pin	Back	Pin	Front	Pin	Back
1	V _{REF}	2	V _{SS}	51	DQS2	52	DM2	101	A1	102	A0	151	DQ42	152	DQ46
3	V _{SS}	4	DQ4	53	V _{SS}	54	V _{SS}	103	V _{DD}	104	V _{DD}	153	DQ43	154	DQ47
5	DQ0	6	DQ5	55	DQ18	56	DQ22	105	A10/AP	106	BA1	155	V _{SS}	156	V _{SS}
7	DQ1	8	V _{SS}	57	DQ19	58	DQ23	107	BA0	108	RAS	157	DQ48	158	DQ52
9	V _{SS}	10	DM0	59	V _{SS}	60	V _{SS}	109	WE	110	S0	159	DQ49	160	DQ53
11	DQS0	12	V _{SS}	61	DQ24	62	DQ28	111	V _{DD}	112	V _{DD}	161	V _{SS}	162	V _{SS}
13	DQS0	14	DQ6	63	DQ25	64	DQ29	113	CAS	114	ODT0	163	NC, TEST	164	CK1
15	V _{SS}	16	DQ7	65	V _{SS}	66	V _{SS}	115	NC/S1	116	A13	165	V _{SS}	166	CK1
17	DQ2	18	V _{SS}	67	DM3	68	DQS3	117	V _{DD}	118	V _{DD}	167	DQS6	168	V _{SS}
19	DQ3	20	DQ12	69	NC	70	DQS3	119	NC/ODT1	120	NC	169	DQS6	170	DM6
21	V _{SS}	22	DQ13	71	V _{SS}	72	V _{SS}	121	V _{SS}	122	V _{SS}	171	V _{SS}	172	V _{SS}
23	DQ8	24	V _{SS}	73	DQ26	74	DQ30	123	DQ32	124	DQ36	173	DQ50	174	DQ54
25	DQ9	26	DM1	75	DQ27	76	DQ31	125	DQ33	126	DQ37	175	DQ51	176	DQ55
27	V _{SS}	28	V _{SS}	77	V _{SS}	78	V _{SS}	127	V _{SS}	128	V _{SS}	177	V _{SS}	178	V _{SS}
29	DQS1	30	CK0	79	CKE0	80	NC/CKE1	129	DQS4	130	DM4	179	DQ56	180	DQ60
31	DQS1	32	CK0	81	V _{DD}	82	V _{DD}	131	DQS4	132	V _{SS}	181	DQ57	182	DQ61
33	V _{SS}	34	V _{SS}	83	NC	84	NC	133	V _{SS}	134	DQ38	183	V _{SS}	184	V _{SS}
35	DQ10	36	DQ14	85	BA2	86	NC	135	DQ34	136	DQ39	185	DM7	186	DQS7
37	DQ11	38	DQ15	87	V _{DD}	88	V _{DD}	137	DQ35	138	V _{SS}	187	V _{SS}	188	DQS7
39	V _{SS}	40	V _{SS}	89	A12	90	A11	139	V _{SS}	140	DQ44	189	DQ58	190	V _{SS}
41	V _{SS}	42	V _{SS}	91	A9	92	A7	141	DQ40	142	DQ45	191	DQ59	192	DQ62
43	DQ16	44	DQ20	93	A8	94	A6	143	DQ41	144	V _{SS}	193	V _{SS}	194	DQ63
45	DQ17	46	DQ21	95	V _{DD}	96	V _{DD}	145	V _{SS}	146	DQS5	195	SDA	196	V _{SS}
47	V _{SS}	48	V _{SS}	97	A5	98	A4	147	DM5	148	DQS5	197	SCL	198	SA0
49	DQS2	50	NC	99	A3	100	A2	149	V _{SS}	150	V _{SS}	199	V _{DD} SPD	200	SA1

Note : NC = No Connect; NC, TEST(pin 163)is for bus analysis tool and is not connected on normal memory modules.

Pin Description

Pin Name	Function	Pin Name	Function
CK0,CK1	Clock Inputs, positive line	SDA	SPD Data Input/Output
CK0,CK1	Clock Inputs, negative line	SA1,SA0	SPD address
CKE0,CKE1	Clock Enables	DQ0~DQ63	Data Input/Output
RAS	Row Address Strobe	DM0~DM7	Data Masks
CAS	Column Address Strobe	DQS0~DQS7	Data strobes
WE	Write Enable	DQS0~DQS7	Data strobes complement
S0,S1	Chip Selects	TEST	Logic Analyzer specific test pin (No connect on So-DIMM)
A0~A9, A11~A13	Address Inputs	V _{DD}	Core and I/O Power
A10/AP	Address Input/Autoprecharge	V _{SS}	Ground
BA0,BA1	SDRAM Bank Address	V _{REF}	Input/Output Reference
ODT0,ODT1	On-die termination control	V _{DD} SPD	SPD Power
SCL	Serial Presence Detect (SPD) Clock Input	NC	Spare pins, No connect

Input/Output Functional Description

Symbol	Type	Function
CK0-CK1 CK0-CK1	Input	The system clock inputs. All address and command lines are sampled on the cross point of the rising edge of CK and falling edge of CK. A Delay Locked Loop (DLL) circuit is driven from the clock input and output timing for read operations is synchronized to the input clock.
CKE0-CKE1	Input	Activates the DDR2 SDRAM CK signal when high and deactivates the CK signal when low. By deactivating the clocks, CKE low initiates the Power Down mode or the Self Refresh mode.
$\overline{S0}$ - $\overline{S1}$	Input	Enables the associated DDR2 SDRAM command decoder when low and disables the command decoder when high. When the command decoder is disabled, new commands are ignored but previous operations continue. Rank 0 is selected by $\overline{S0}$, Rank 1 is selected by $\overline{S1}$. Ranks are also called "Physical banks".
\overline{RAS} , \overline{CAS} , \overline{WE}	Input	When sampled at the cross point of the rising edge of CK and falling edge of \overline{CK} , \overline{CAS} , \overline{RAS} , and \overline{WE} define the operation to be executed by the SDRAM.
BA0-BA1	Input	Selects which DDR2 SDRAM internal bank is activated.
ODT0-ODT1	Input	Asserts on-die termination for DQ, DM, DQS, and \overline{DQS} signals if enabled via the DDR2 SDRAM Extended Mode Register Set (EMRS).
A0~A9, A10/AP, A11~A13	Input	During a Bank Activate command cycle, defines the row address when sampled at the cross point of the rising edge of CK and falling edge of CK. During a Read or Write command cycle, defines the column address when sampled at the cross point of the rising edge of CK and falling edge of CK. In addition to the column address, AP is used to invoke autoprecharge operation at the end of the burst read or write cycle. If AP is high, autoprecharge is selected and BA0-BAN defines the bank to be precharged. If AP is low, autoprecharge is disabled. During a Precharge command cycle, AP is used in conjunction with BA0-BAN to control which bank(s) to precharge. If AP is high, all banks will be precharged regardless of the state of BA0-BAN inputs. If AP is low, then BA0-BAN are used to define which bank to precharge.
DQ0~DQ63	In/Out	Data Input/Output pins.
DM0-DM7	Input	The data write masks, associated with one data byte. In Write mode, DM operates as a byte mask by allowing input data to be written if it is low but blocks the write operation if it is high. In Read mode, DM lines have no effect.
DQS0~DQS7 $\overline{DQS0}$ - $\overline{DQS7}$	In/Out	The data strobes, associated with one data byte, sourced with data transfers. In Write mode, the data strobe is sourced by the controller and is centered in the data window. In Read mode, the data strobe is sourced by the DDR2 SDRAMs and is sent at the leading edge of the data window. \overline{DQS} signals are complements, and timing is relative to the crosspoint of respective DQS and \overline{DQS} . If the module is to be operated in single ended strobe mode, all \overline{DQS} signals must be tied on the system board to VSS and DDR2 SDRAM mode registers programmed appropriately.
V _{DD} , V _{DD} SPD, V _{SS}	Supply	Power supplies for core, I/O, Serial Presence Detect, and ground for the module.
SDA	In/Out	This is a bidirectional pin used to transfer data into or out of the SPD EEPROM. A resistor must be connected to V _{DD} to act as a pull up.
SCL	Input	This signal is used to clock data into and out of the SPD EEPROM. A resistor may be connected from SCL to V _{DD} to act as a pull up.
SA0-SA1	Input	Address pins used to select the Serial Presence Detect base address.
TEST	In/Out	The TEST pin is reserved for bus analysis tools and is not connected on normal memory modules(SO-DIMMs).

Functional Block Diagram: 512MB, 64Mx64 Module (Populated as 2 rank of x16 DDR2 SDRAMs)
M470T6554BG(Z)3/M470T6554BG(Z)0

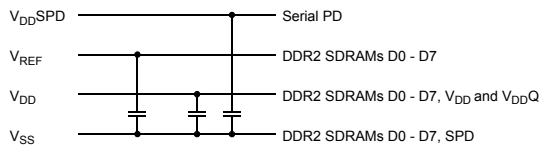
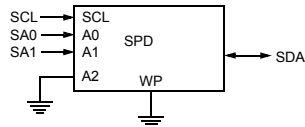
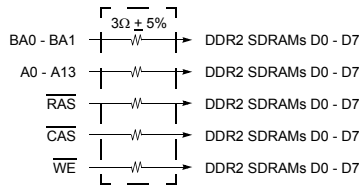
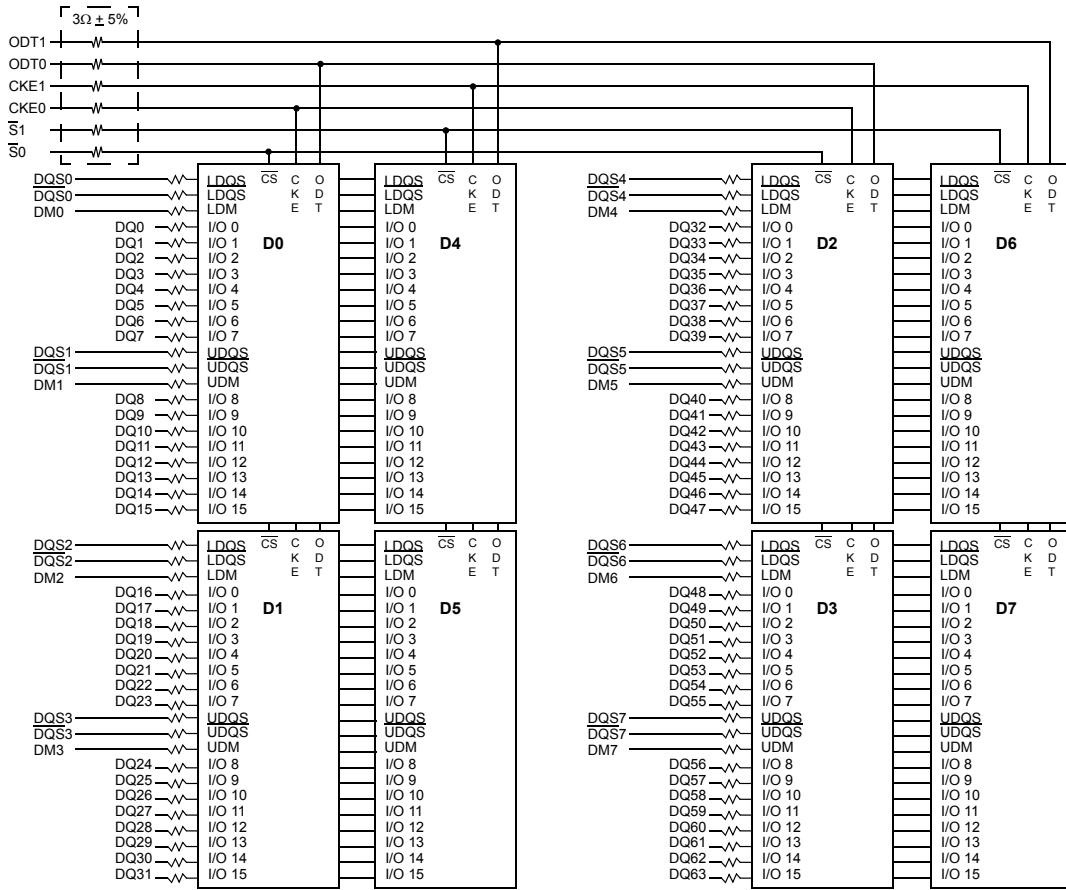

* Clock Wiring	
Clock Input	DDR2 SDRAMs
*CK0/CK0	4 DDR2 SDRAMs
*CK1/CK1	4 DDR2 SDRAMs

* Wire per Clock Loading Table/Wiring Diagrams

Notes :

1. DQ,DM, DQS/DQS# resistors : 22 Ohms ± 5%.
2. BAX, Ax, RAS, CAS, WE resistors : 3.0 Ohms ± 5%.

Functional Block Diagram: 256MB, 32Mx64 Module (Populated as 1 rank of x16 DDR2 SDRAMs)
M470T3354BG(Z)3/M470T3354BG(Z)0

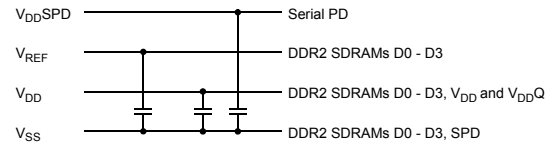
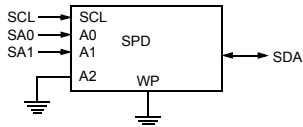
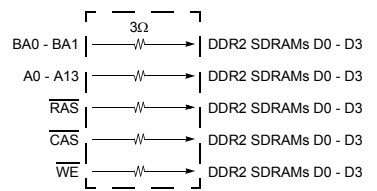
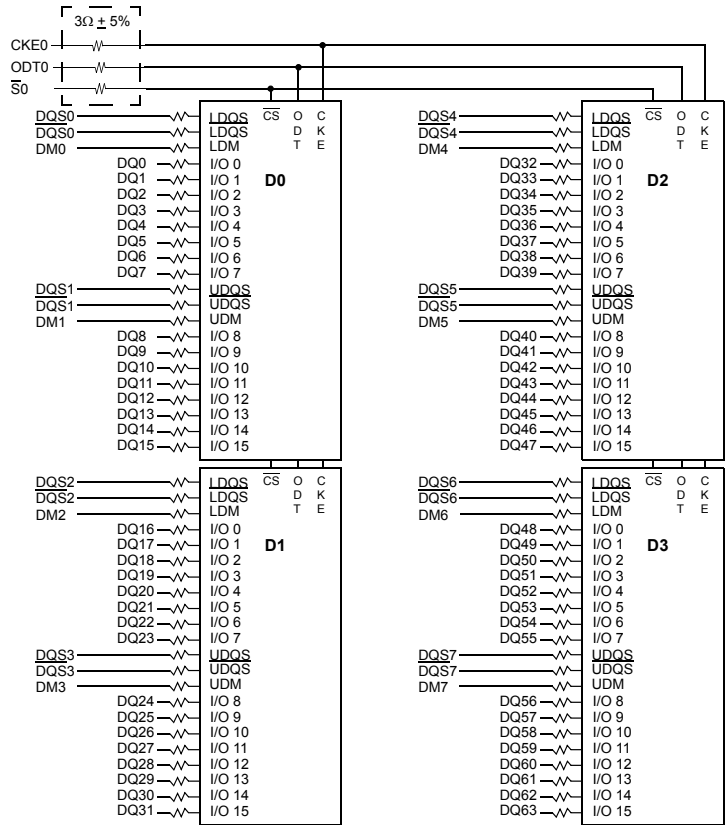

* Clock Wiring	
Clock Input	DDR2 SDRAMs
*CK0/CK0	2 DDR2 SDRAMs
*CK1/CK1	2 DDR2 SDRAMs

* Wire per Clock Loading Table/Wiring Diagrams

- Notes :
1. DQ, DM, DQS/DQS resistors : 22 Ohms ± 5%.
 2. BAx, Ax, RAS, CAS, WE resistors : 3.0 Ohms ± 5%.

Functional Block Diagram: 1GB, 128Mx64 Module(Populated as 2 ranks of x8 DDR2 SDRAMs)
M470T2953BS(Y)3/M470T2953BS(Y)0

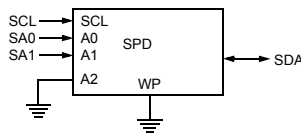
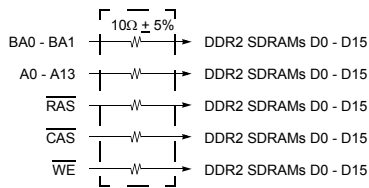
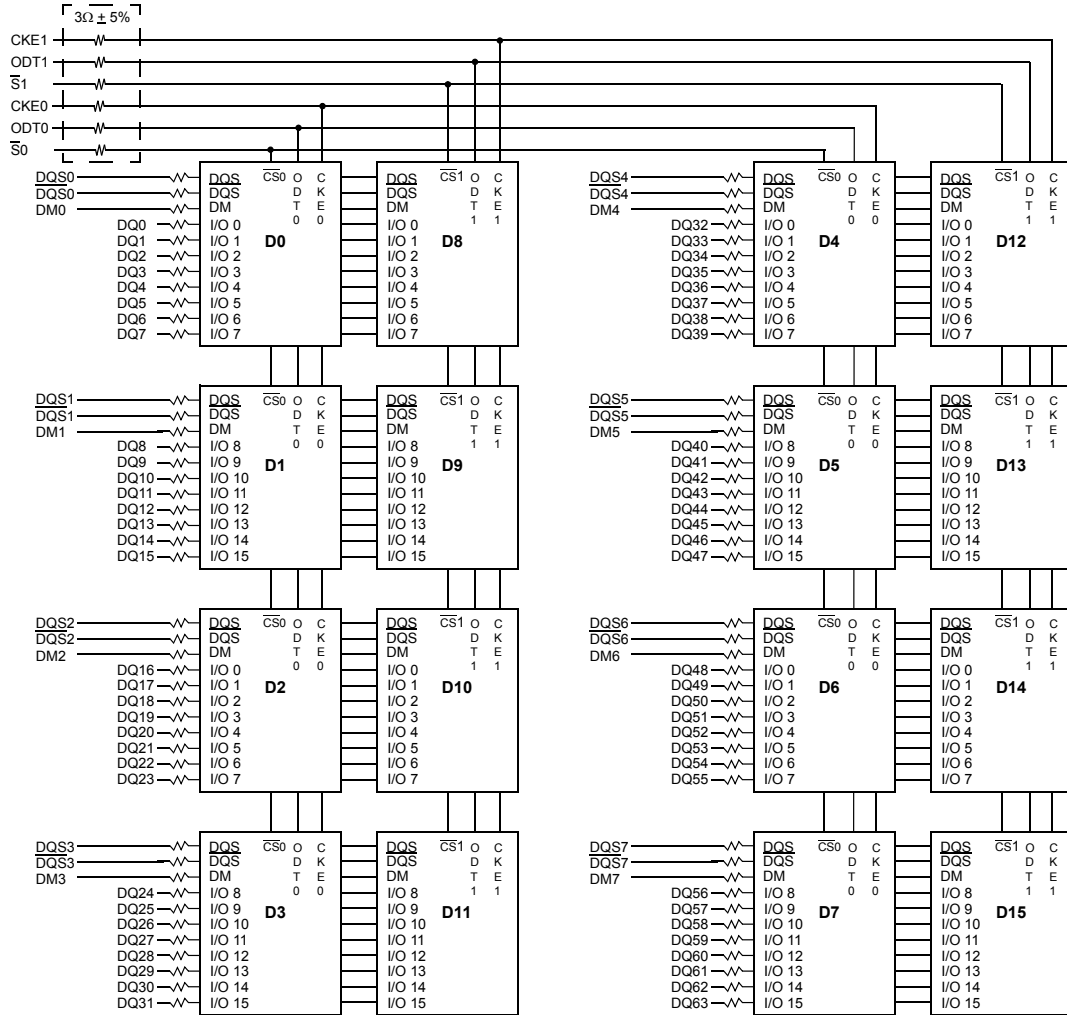

* Clock Wiring	
Clock Input	DDR2 SDRAMs
*CK0/CK0	8 DDR2 SDRAMs
*CK1/CK1	8 DDR2 SDRAMs

* Wire per Clock Loading Table/Wiring Diagrams

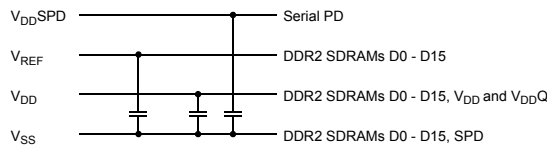

- Notes :
1. DQ,DM, DQS/DQS resistors : 22 Ohms ± 5%.
 2. BAx, Ax, RAS, CAS, WE resistors : 10 Ohms ± 5%.

Absolute Maximum DC Ratings

Symbol	Parameter	Rating	Units	Notes
V_{DD}	Voltage on V_{DD} pin relative to V_{SS}	- 1.0 V ~ 2.3 V	V	1
V_{DDQ}	Voltage on V_{DDQ} pin relative to V_{SS}	- 0.5 V ~ 2.3 V	V	1
V_{DDL}	Voltage on V_{DDL} pin relative to V_{SS}	- 0.5 V ~ 2.3 V	V	1
V_{IN}, V_{OUT}	Voltage on any pin relative to V_{SS}	- 0.5 V ~ 2.3 V	V	1
T_{STG}	Storage Temperature	-55 to +100	°C	1, 2

Note :

- Stresses greater than those listed under "Absolute Maximum Ratings" may cause permanent damage to the device. This is a stress rating only and functional operation of the device at these or any other conditions above those indicated in the operational sections of this specification is not implied. Exposure to absolute maximum rating conditions for extended periods may affect reliability.
- Storage Temperature is the case surface temperature on the center/top side of the DRAM. For the measurement conditions, please refer to JESD51-2 standard.

AC & DC Operating Conditions

Recommended DC Operating Conditions (SSTL - 1.8)

Symbol	Parameter	Rating			Units	Notes
		Min.	Typ.	Max.		
V_{DD}	Supply Voltage	1.7	1.8	1.9	V	
V_{DDL}	Supply Voltage for DLL	1.7	1.8	1.9	V	4
V_{DDQ}	Supply Voltage for Output	1.7	1.8	1.9	V	4
V_{REF}	Input Reference Voltage	$0.49 \cdot V_{DDQ}$	$0.50 \cdot V_{DDQ}$	$0.51 \cdot V_{DDQ}$	mV	1,2
V_{TT}	Termination Voltage	$V_{REF} - 0.04$	V_{REF}	$V_{REF} + 0.04$	V	3

Note : There is no specific device V_{DD} supply voltage requirement for SSTL-1.8 compliance. However under all conditions V_{DDQ} must be less than or equal to V_{DD} .

- The value of V_{REF} may be selected by the user to provide optimum noise margin in the system. Typically the value of V_{REF} is expected to be about $0.5 \times V_{DDQ}$ of the transmitting device and V_{REF} is expected to track variations in V_{DDQ} .
- Peak to peak AC noise on V_{REF} may not exceed $\pm 2\% V_{REF}(DC)$.
- V_{TT} of transmitting device must track V_{REF} of receiving device.
- AC parameters are measured with V_{DD} , V_{DDQ} and V_{DDL} tied together.

Operating Temperature Condition

Symbol	Parameter	Rating	Units	Notes
TOPER	Operating Temperature	0 to 95	°C	1, 2, 3

Note :

- Operating Temperature is the case surface temperature on the center/top side of the DRAM. For the measurement conditions, please refer to JESD51.2 standard.
- At 0 - 85 °C, operation temperature range are the temperature which all DRAM specification will be supported.
- At 85 - 95 °C operation temperature range, doubling refresh commands in frequency to a 32ms period (tREFI=3.9 us) is required, and to enter to self refresh mode at this temperature range, an EMRS command is required to change internal refresh rate.

Input DC Logic Level

Symbol	Parameter	Min.	Max.	Units	Notes
V _{IH} (DC)	DC input logic high	V _{REF} + 0.125	V _{DDQ} + 0.3	V	
V _{IL} (DC)	DC input logic low	- 0.3	V _{REF} - 0.125	V	

Input AC Logic Level

Symbol	Parameter	Min.	Max.	Units	Notes
V _{IH} (AC)	AC input logic high	V _{REF} + 0.250	-	V	
V _{IL} (AC)	AC input logic low	-	V _{REF} - 0.250	V	

AC Input Test Conditions

Symbol	Condition	Value	Units	Notes
V _{REF}	Input reference voltage	0.5 * V _{DDQ}	V	1
V _{SWING} (MAX)	Input signal maximum peak to peak swing	1.0	V	1
SLEW	Input signal minimum slew rate	1.0	V/ns	2, 3

Notes:

- Input waveform timing is referenced to the input signal crossing through the V_{IH/IL}(AC) level applied to the device under test.
- The input signal minimum slew rate is to be maintained over the range from V_{REF} to V_{IH}(AC) min for rising edges and the range from V_{REF} to V_{IL}(AC) max for falling edges as shown in the below figure.
- AC timings are referenced with input waveforms switching from V_{IL}(AC) to V_{IH}(AC) on the positive transitions and V_{IH}(AC) to V_{IL}(AC) on the negative transitions.

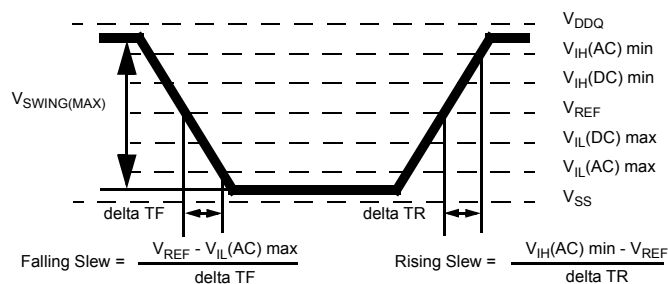

< AC Input Test Signal Waveform >

IDD Specification Parameters Definition

(IDD values are for full operating range of Voltage and Temperature)

Symbol	Proposed Conditions	Units	Notes
IDD0	Operating one bank active-precharge current; $t_{CK} = t_{CK}(IDD)$, $t_{RC} = t_{RC}(IDD)$, $t_{RAS} = t_{RASmin}(IDD)$; CKE is HIGH, CS\ is HIGH between valid commands; Address bus inputs are SWITCHING; Data bus inputs are SWITCHING	mA	
IDD1	Operating one bank active-read-precharge current; $I_{OUT} = 0mA$; BL = 4, CL = CL(IDD), AL = 0; $t_{CK} = t_{CK}(IDD)$, $t_{RC} = t_{RC}(IDD)$, $t_{RAS} = t_{RASmin}(IDD)$, $t_{RCD} = t_{RCD}(IDD)$; CKE is HIGH, CS\ is HIGH between valid commands; Address bus inputs are SWITCHING; Data pattern is same as IDD4W	mA	
IDD2P	Precharge power-down current; All banks idle; $t_{CK} = t_{CK}(IDD)$; CKE is LOW; Other control and address bus inputs are STABLE; Data bus inputs are FLOATING	mA	
IDD2Q	Precharge quiet standby current; All banks idle; $t_{CK} = t_{CK}(IDD)$; CKE is HIGH, CS\ is HIGH; Other control and address bus inputs are STABLE; Data bus inputs are FLOATING	mA	
IDD2N	Precharge standby current; All banks idle; $t_{CK} = t_{CK}(IDD)$; CKE is HIGH, CS\ is HIGH; Other control and address bus inputs are SWITCHING; Data bus inputs are SWITCHING	mA	
IDD3P	Active power-down current; All banks open; $t_{CK} = t_{CK}(IDD)$; CKE is LOW; Other control and address bus inputs are STABLE; Data bus inputs are FLOATING	Fast PDN Exit MRS(12) = 0mA	mA
		Slow PDN Exit MRS(12) = 1mA	mA
IDD3N	Active standby current; All banks open; $t_{CK} = t_{CK}(IDD)$, $t_{RAS} = t_{RASmax}(IDD)$, $t_{RP} = t_{RP}(IDD)$; CKE is HIGH, CS\ is HIGH between valid commands; Other control and address bus inputs are SWITCHING; Data bus inputs are SWITCHING	mA	
IDD4W	Operating burst write current; All banks open, Continuous burst writes; BL = 4, CL = CL(IDD), AL = 0; $t_{CK} = t_{CK}(IDD)$, $t_{RAS} = t_{RASmax}(IDD)$, $t_{RP} = t_{RP}(IDD)$; CKE is HIGH, CS\ is HIGH between valid commands; Address bus inputs are SWITCHING; Data bus inputs are SWITCHING	mA	
IDD4R	Operating burst read current; All banks open, Continuous burst reads, $I_{OUT} = 0mA$; BL = 4, CL = CL(IDD), AL = 0; $t_{CK} = t_{CK}(IDD)$, $t_{RAS} = t_{RASmax}(IDD)$, $t_{RP} = t_{RP}(IDD)$; CKE is HIGH, CS\ is HIGH between valid commands; Address bus inputs are SWITCHING; Data pattern is same as IDD4W	mA	
IDD5B	Burst auto refresh current; $t_{CK} = t_{CK}(IDD)$; Refresh command at every $t_{RFC}(IDD)$ interval; CKE is HIGH, CS\ is HIGH between valid commands; Other control and address bus inputs are SWITCHING; Data bus inputs are SWITCHING	mA	
IDD6	Self refresh current; CK and CK\ at 0V; CKE $\leq 0.2V$; Other control and address bus inputs are FLOATING; Data bus inputs are FLOATING	Normal	mA
		Low Power	mA
IDD7	Operating bank interleave read current; All bank interleaving reads, $I_{OUT} = 0mA$; BL = 4, CL = CL(IDD), AL = $t_{RCD}(IDD) - 1 * t_{CK}(IDD)$; $t_{CK} = t_{CK}(IDD)$, $t_{RC} = t_{RC}(IDD)$, $t_{RRD} = t_{RRD}(IDD)$, $t_{FAW} = t_{FAW}(IDD)$, $t_{RCD} = 1 * t_{CK}(IDD)$; CKE is HIGH, CS\ is HIGH between valid commands; Address bus inputs are STABLE during DESELECTs; Data pattern is same as IDD4R; Refer to the following page for detailed timing conditions	mA	

Operating Current Table(1-1) (T_A=0°C, VDD= 1.9V)

M470T6554BG(Z)3/M470T6554BG(Z)0 : 64Mx64 512MB Module

Symbol	CD5 (DDR533@CL=4)	LD5 (DDR533@CL=4)	CCC (DDR400@CL=3)	LCC (DDR400@CL=3)	Unit	Notes
IDD0	760	460	720	460	mA	
IDD1	860	560	760	520	mA	
IDD2P	64	64	64	64	mA	
IDD2Q	200	200	200	200	mA	
IDD2N	240	200	240	200	mA	
IDD3P-F	240	120	240	120	mA	
IDD3P-S	120	120	120	120	mA	
IDD3N	560	260	520	260	mA	
IDD4W	1,200	700	1,000	700	mA	
IDD4R	1,100	700	940	700	mA	
IDD5B	1,060	860	1,000	860	mA	
IDD6	44	40	44	40	mA	
IDD7	1,840	1,060	1,760	1,060	mA	

* Module IDD was calculated on the basis of component IDD and can be differently measured according to DQ loading cap.

M470T3354BG(Z)3/M470T3354BG(Z)0 : 32Mx64 256MB Module

Symbol	CD5 (DDR533@CL=4)	LD5 (DDR533@CL=4)	CCC (DDR400@CL=3)	LCC (DDR400@CL=3)	Unit	Notes
IDD0	480	360	460	360	mA	
IDD1	580	460	500	420	mA	
IDD2P	32	32	32	32	mA	
IDD2Q	100	100	100	100	mA	
IDD2N	120	100	120	100	mA	
IDD3P-F	120	60	120	60	mA	
IDD3P-S	60	60	60	60	mA	
IDD3N	280	160	260	160	mA	
IDD4W	920	600	740	520	mA	
IDD4R	820	600	680	520	mA	
IDD5B	780	760	740	760	mA	
IDD6	22	20	22	20	mA	
IDD7	1,560	960	1,500	960	mA	

* Module IDD was calculated on the basis of component IDD and can be differently measured according to DQ loading cap.

Operating Current Table(1-2) (TA=0°C, VDD= 1.9V)

M470T2953BS(Y)3/M470T2953BS(Y)0 : 128Mx64 1GB Module

Symbol	CD5 (DDR533@CL=4)	LD5 (DDR533@CL=4)	CCC (DDR400@CL=3)	LCC (DDR400@CL=3)	Unit	Notes
IDD0	1,360	760	1,280	760	mA	
IDD1	1,440	920	1,320	840	mA	
IDD2P	128	128	128	128	mA	
IDD2Q	400	400	400	400	mA	
IDD2N	480	400	480	400	mA	
IDD3P-F	480	240	480	240	mA	
IDD3P-S	240	240	240	240	mA	
IDD3N	1,120	520	1,040	520	mA	
IDD4W	2,160	1,160	1,680	1,000	mA	
IDD4R	2,000	1,160	1,680	1,000	mA	
IDD5B	2,120	1,720	2,000	1,720	mA	
IDD6	88	80	88	80	mA	
IDD7	2,760	1,960	2,680	1,960	mA	

* Module IDD was calculated on the basis of component IDD and can be differently measured according to DQ loading cap.

Input/Output Capacitance(VDD=1.8V, VDDQ=1.8V, TA=25°C)

Parameter	Symbol	Min	Max	Min	Max	Min	Max	Units
		M470T6554BG(Z)3 M470T6554BG(Z)0		M470T3354BG(Z)3 M470T3354BG(Z)0		M470T2953BS(Y)3 M470T2953BS(Y)0		
Input capacitance, CK and $\overline{\text{CK}}$	CCK	-	32	-	24	-	48	pF
Input capacitance, CKE, $\overline{\text{CS}}$, Addr, $\overline{\text{RAS}}$, $\overline{\text{CAS}}$, $\overline{\text{WE}}$	CI	-	34	-	34	-	42	
Input/output capacitance, DQ, DM, DQS, $\overline{\text{DQS}}$	CIO	-	10	-	6	-	10	

* DM is internally loaded to match DQ and DQS identically.

Electrical Characteristics & AC Timing for DDR2-533/400 SDRAM

(0 °C ≤ T_{CASE} ≤ 95 °C; V_{DDQ} = 1.8V ± 0.1V; V_{DD} = 1.8V ± 0.1V)

Refresh Parameters by Device Density

Parameter	Symbol	256Mb	512Mb	1Gb	2Gb	4Gb	Units
Refresh to active/Refresh command time	tRFC	75	105	127.5	195	tbd	ns
Average periodic refresh interval	tREFI	0 °C ≤ T _{CASE} ≤ 85 °C	7.8	7.8	7.8	7.8	μs
		85 °C < T _{CASE} ≤ 95 °C	3.9	3.9	3.9	3.9	μs

Speed Bins and CL, tRCD, tRP, tRC and tRAS for Corresponding Bin

Speed	DDR2-533(D5)		DDR2-400(CC)		Units
Bin (CL - tRCD - tRP)	4 - 4 - 4		3 - 3 - 3		
Parameter	min	max	min	max	
tCK, CL=3	5	8	5	8	ns
tCK, CL=4	3.75	8	5	8	ns
tCK, CL=5	-	-	-	-	ns
tRCD	15		15		ns
tRP	15		15		ns
tRC	55		55		ns
tRAS	40	70000	40	70000	ns

Timing Parameters by Speed Grade

(Refer to notes for informations related to this table at the bottom)

Parameter	Symbol	DDR2-533		DDR2-400		Units	Notes
		min	max	min	max		
DQ output access time from CK/CK	tAC	-500	+500	-600	+600	ps	
DQS output access time from CK/CK	tDQSK	-450	+450	-500	+500	ps	
CK high-level width	tCH	0.45	0.55	0.45	0.55	tCK	
CK low-level width	tCL	0.45	0.55	0.45	0.55	tCK	
CK half period	tHP	min(tCL, tCH)	x	min(tCL, tCH)	x	ps	
Clock cycle time, CL=x	tCK	3750	8000	5000	8000	ps	
DQ and DM input hold time	tDH	225	x	275	x	ps	
DQ and DM input setup time	tDS	100	x	150	x	ps	
Control & Address input pulse width for each input	tIPW	0.6	x	0.6	x	tCK	
DQ and DM input pulse width for each input	tDIPW	0.35	x	0.35	x	tCK	
Data-out high-impedance time from CK/CK	tHZ	x	tAC max	x	tAC max	ps	
DQS low-impedance time from CK/CK	tLZ(DQS)	tAC min	tAC max	tAC min	tAC max	ps	
DQ low-impedance time from CK/CK	tLZ(DQ)	2* tACmin	tAC max	2* tACmin	tAC max	ps	
DQS-DQ skew for DQS and associated DQ signals	tDQSQ	x	300	x	350	ps	
DQ hold skew factor	tQHS	x	400	x	450	ps	
DQ/DQS output hold time from DQS	tQH	tHP - tQHS	x	tHP - tQHS	x	ps	
Write command to first DQS latching transition	tDQSS	WL-0.25	WL+0.25	WL-0.25	WL+0.25	tCK	
DQS input high pulse width	tDQSH	0.35	x	0.35	x	tCK	
DQS input low pulse width	tDQSL	0.35	x	0.35	x	tCK	
DQS falling edge to CK setup time	tDSS	0.2	x	0.2	x	tCK	
DQS falling edge hold time from CK	tDSH	0.2	x	0.2	x	tCK	
Mode register set command cycle time	tMRD	2	x	2	x	tCK	
Write postamble	tWPST	0.4	0.6	0.4	0.6	tCK	
Write preamble	tWPRE	0.35	x	0.35	x	tCK	
Address and control input hold time	tIH	375	x	475	x	ps	
Address and control input setup time	tIS	250	x	350	x	ps	
Read preamble	tRPRE	0.9	1.1	0.9	1.1	tCK	
Read postamble	tRPST	0.4	0.6	0.4	0.6	tCK	
Active to active command period for 1KB page size products	tRRD	7.5	x	7.5	x	ns	
Active to active command period for 2KB page size products	tRRD	10	x	10	x	ns	
Four Activate Window for 1KB page size products	tFAW	37.5		37.5		ns	
Four Activate Window for 2KB page size products	tFAW	50		50		ns	
CAS to CAS command delay	tCCD	2		2		tCK	
Write recovery time	tWR	15	x	15	x	ns	
Auto precharge write recovery + precharge time	tDAL	tWR+tRP	x	tWR+tRP	x	tCK	
Internal write to read command delay	tWTR	7.5	x	10	x	ns	
Internal read to precharge command delay	tRTP	7.5		7.5		ns	
Exit self refresh to a non-read command	tXSNR	tRFC + 10		tRFC + 10		ns	
Exit self refresh to a read command	tXSRD	200		200		tCK	
Exit precharge power down to any non-read command	tXP	2	x	2	x	tCK	
Exit active power down to read command	tXARD	2	x	2	x	tCK	
Exit active power down to read command (Slow exit, Lower power)	tXARDS	6 - AL		6 - AL		tCK	

Parameter	Symbol	DDR2-533		DDR2-400		Units	Notes
		min	max	min	max		
CKE minimum pulse width (high and low pulse width)	tCKE	3		3		tCK	
ODT turn-on delay	tAOND	2	2	2	2	tCK	
ODT turn-on	tAON	tAC(min)	tAC(max)+1	tAC(min)	tAC(max)+1	ns	
ODT turn-on(Power-Down mode)	tAONPD	tAC(min)+2	2tCK+tAC(max)+1	tAC(min)+2	2tCK+tAC(max)+1	ns	
ODT turn-off delay	tAOFD	2.5	2.5	2.5	2.5	tCK	
ODT turn-off	tAOF	tAC(min)	tAC(max)+0.6	tAC(min)	tAC(max)+0.6	ns	
ODT turn-off (Power-Down mode)	tAOFPD	tAC(min)+2	2.5tCK+tAC(max)+1	tAC(min)+2	2.5tCK+tAC(max)+1	ns	
ODT to power down entry latency	tANPD	3		3		tCK	
ODT power down exit latency	tAXPD	8		8		tCK	
OCD drive mode output delay	tOIT	0	12	0	12	ns	
Minimum time clocks remains ON after CKE asynchronously drops LOW	tDelay	tIS+tCK +tIH		tIS+tCK +tIH		ns	

Physical Dimensions: 32Mbx16 based 64Mx64 Module(2 Rank)
M470T6554BG(Z)3/M470T6554BG(Z)0

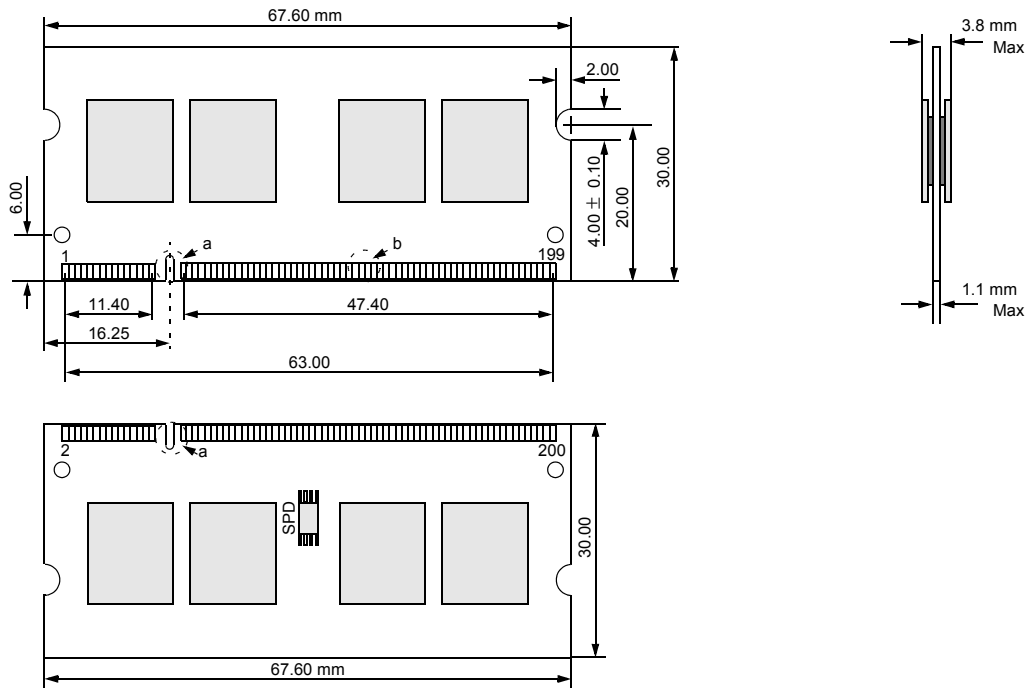

DETAIL a

DETAIL b

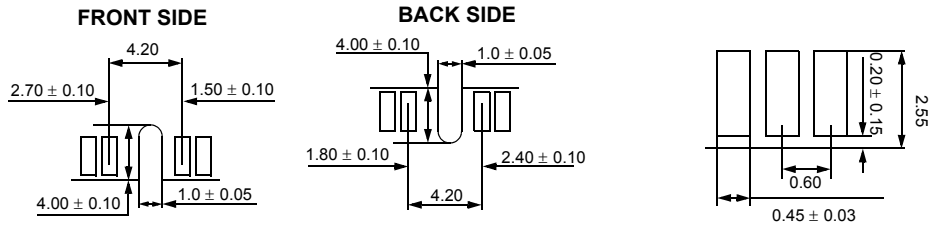

The used device is 32M x16 DDR2 SDRAM, FBGA.
DDR2 SDRAM Part NO : K4T51163QB

Physical Dimensions: 32Mbx16 based 32Mx64 Module(1 Rank)
M470T3354BG(Z)3/M470T3354BG(Z)0

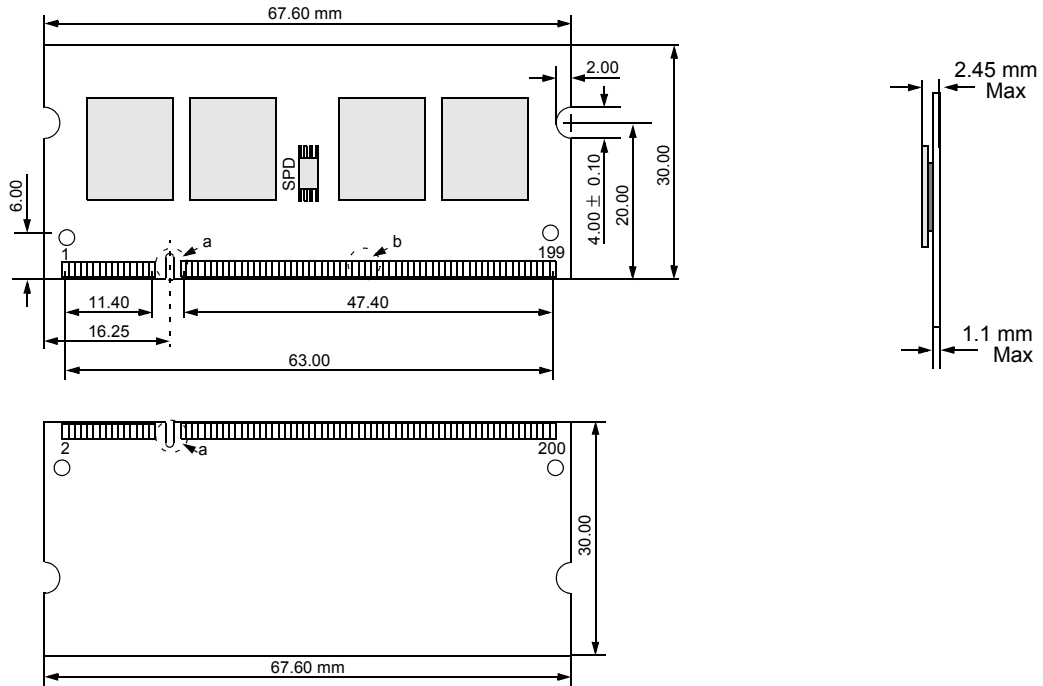

DETAIL a

DETAIL b

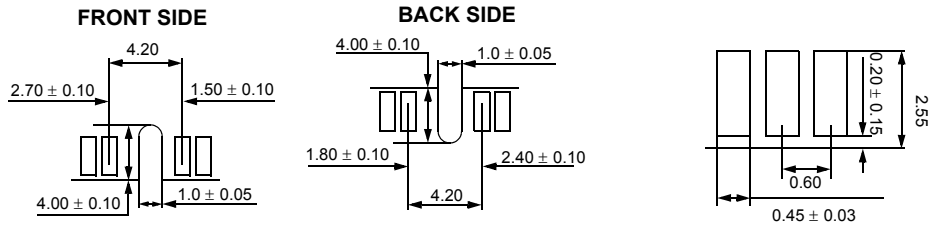

The used device is 32M x16 DDR2 SDRAM, FBGA.
DDR2 SDRAM Part NO : K4T51163QB

Physical Dimensions: 64Mbx8 based 128Mx64 Module(2 Ranks)
M470T2953BS(Y)3/M470T2953BS(Y)0

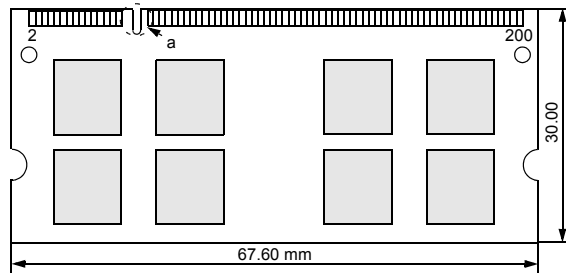
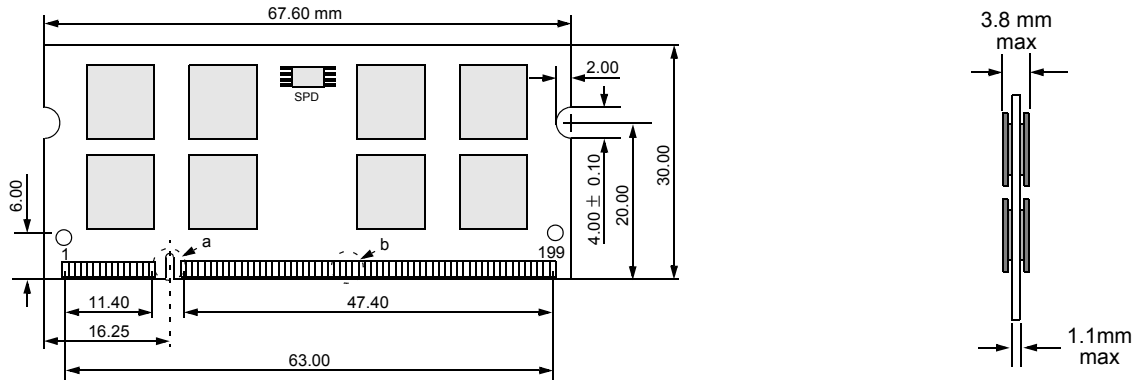

DETAIL a

DETAIL b

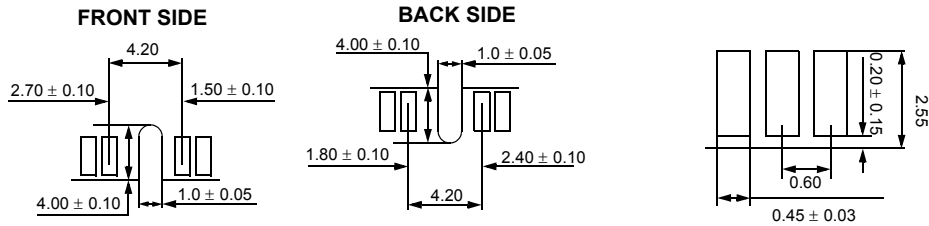

The used device is 64M x8 DDR2 SDRAM, FBGA.
DDR2 SDRAM Part NO : K4T51083QB

Revision History

Revision 1.0 (Jan. 2004)

- Initial Release

Revision 1.1 (Jun. 2004)

- Added lead-free part number in the ordering information
- Changed IDD2P

Revision 1.2 (Jul. 2004)

- Added current values and part number of low power product

Revision 1.3 (Feb. 2005)

- Added the detail information for mechanical dimension

Revision 1.4 (Mar. 2005)

- Changed 1GB Functional Block Diagram

Revision 1.5 (Aug. 2005)

- Changed the IDD Specification Parameters Definition