

### FEATURES

- Plastic package has Underwriters Laboratory Flammability Classification 94V-0
- Metal silicon junction ,majority carrier conduction
- Guard ring for overvoltage protection
- Low power loss ,high efficiency
- High current capability ,Low forward voltage drop
- High surge capability
- For use in low voltage ,high frequency inverters, free wheeling ,and polarity protection applications
- Dual rectifier construction
- High temperature soldering guaranteed:260° C/10 seconds,, 0.25"(6.35mm)from case
- Component in accordance to RoHS 2002/95/EC and WEEE 2002/96/EC

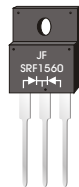

### ITO-220AB

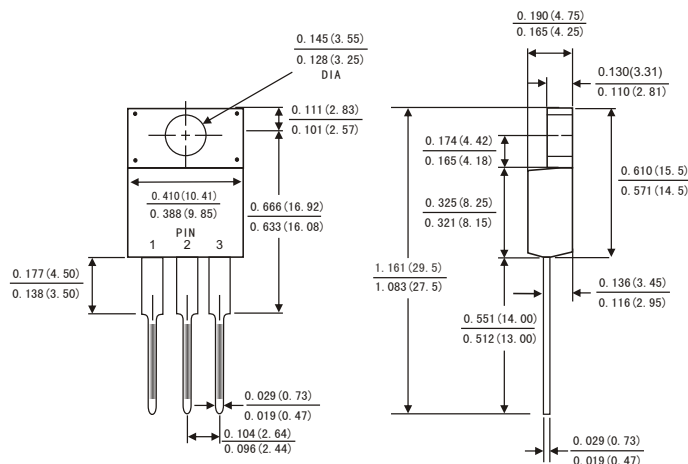

### MECHANICAL DATA

- Case: JEDEC ITO-220AB molded plastic body
- Terminals: Lead solderable per MIL-STD-750,method 2026
- Polarity: As marked.
- Mounting Position: Any
- Weight: 0.08ounce, 2.24 gram

Dimensions in inches and (millimeters)

### MAXIMUM RATINGS AND ELECTRICAL CHARACTERISTICS

(Ratings at 25°C ambient temperature unless otherwise specified ,Single phase ,half wave ,resistive or inductive load. For capacitive load, derate by 20%.)

	Symbols	SRF 1535	SRF 1545	SRF 1550	SRF 1560	SRF 15A0	SRF 15150	SRF 15200	Units
Maximum repetitive peak reverse voltage	VRRM	35	45	50	60	100	150	200	Volts
Maximum RMS voltage	VRMS	25	32	35	42	70	105	140	Volts
Maximum DC blocking voltage	VDC	35	45	50	60	100	150	200	Volts
Maximum average forward rectified current See Fig. 1	I(AV)	15.0							Amps
Peak forward surge current 8.3ms single half sine-wave superimposed on rated load (JEDEC method)	IFSM	150.0							Amps
Maximum instantaneous forward voltage at 15 A	VF	0.60		0.75	0.85	0.90	0.95		Volts
Maximum instantaneous reverse current at rated DC blocking voltage(Note 1)	T <sub>c</sub> = 25°C	0.5							mA
	T <sub>c</sub> = 125°C	30			50				
Typical thermal resistance (Note 2)	R <sub>θJC</sub>	3.0							°C/W
Operating junction temperature range	T <sub>J</sub>	-65 to+125			-65 to+150				°C
Storage temperature range	T <sub>STG</sub>	-65 to+150							°C

Notes: 1.Pulse test: 300 μs pulse width,1% duty cycle

2.Thermal resistance from junction to case

1-120

# RATINGS AND CHARACTERISTIC CURVES SRF1535 THRU SRF15200

FIG.1-FORWARD CURRENT DERATING CURVE

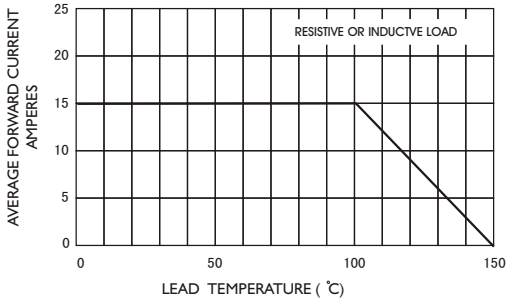

FIG.2-MAXIMUM NON-REPETITIVE PEAK FORWARD SURGE CURRENT

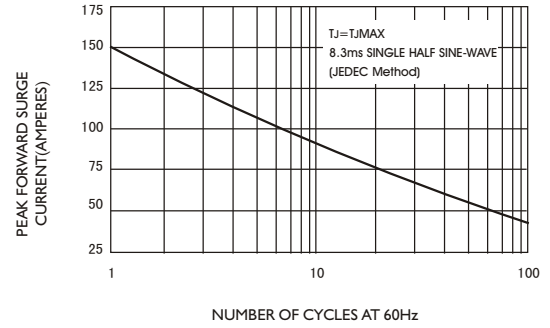

FIG.3-TYPICAL INSTANTANEOUS FORWARD CHARACTERISTICS

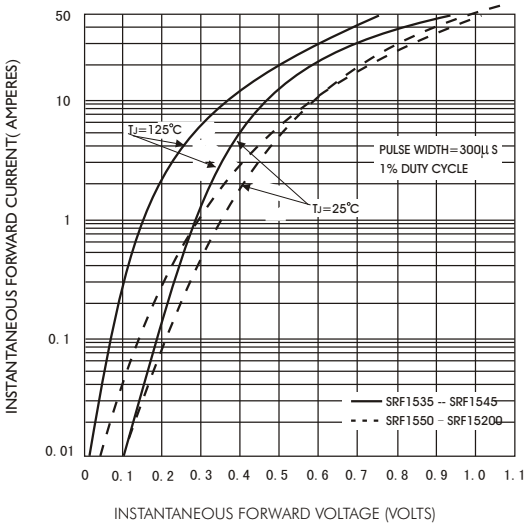

FIG.4-TYPICAL REVERSE CHARACTERISTICS

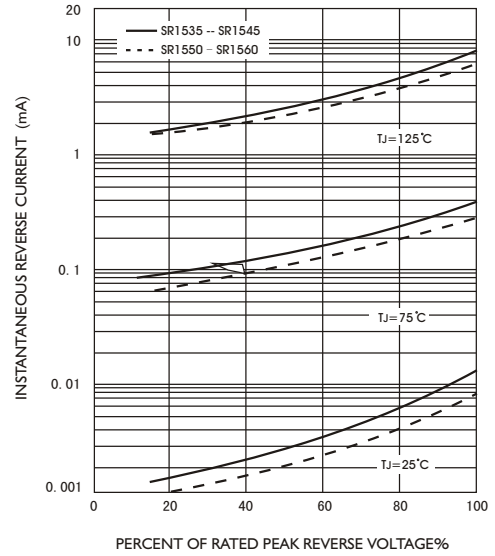

FIG.5-TYPICAL JUNCTION CAPACITANCE

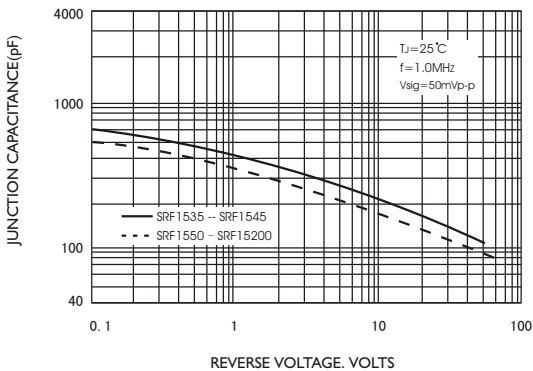

FIG.6-TYPICAL TRANSIENT THERMAL IMPEDANCE

