

FEATURES

- Plastic package has Underwriters Laboratory Flammability Classification 94V-0
- Metal silicon junction ,majority carrier conduction
- Guard ring for overvoltage protection
- Low power loss ,high efficiency
- High current capability ,Low forward voltage drop
- High surge capability
- For use in low voltage ,high frequency inverters, free wheeling ,and polarity protection applications
- Dual rectifier construction
- High temperature soldering guaranteed:260° C/10 seconds, 0.25"(6.35mm)from case
- Component in accordance to RoHS 2002/95/EC and WEEE 2002/96/EC

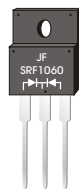

ITO-220AB

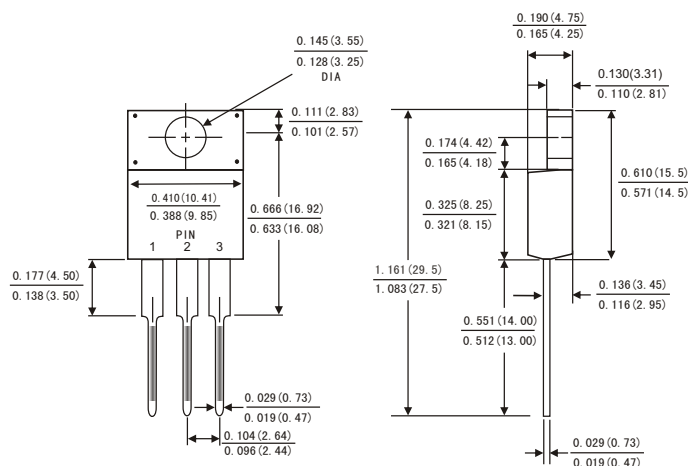

MECHANICAL DATA

- Case: JEDEC ITO-220AB molded plastic body
- Terminals: Lead solderable per MIL-STD-750,method 2026
- Polarity: As marked.
- Mounting Position: Any
- Weight: 0.08ounce, 2.24 gram

Dimensions in inches and (millimeters)

MAXIMUM RATINGS AND ELECTRICAL CHARACTERISTICS

(Ratings at 25° C ambient temperature unless otherwise specified ,Single phase ,half wave ,resistive or inductive load. For capacitive load,derate by 20%.)

| | Symbols | SRF 1020 | SRF 1030 | SRF 1040 | SRF 1050 | SRF 1060 | SRF 1080 | SRF 10A0 | SRF 10150 | SRF 10200 | Units |
|--|------------|------------|----------|----------|------------|----------|----------|----------|-----------|-----------|-------|
| Maximum repetitive peak reverse voltage | VRRM | 20 | 30 | 40 | 50 | 60 | 80 | 100 | 150 | 200 | Volts |
| Maximum RMS voltage | VRMS | 14 | 21 | 28 | 35 | 42 | 56 | 70 | 105 | 140 | Volts |
| Maximum DC blocking voltage | VDC | 20 | 30 | 40 | 50 | 60 | 80 | 100 | 150 | 200 | Volts |
| Maximum average forward rectified current (see Fig.1) | I(AV) | 10 | | | | | | | | | Amps |
| Peak forward surge current 8.3ms single half sine-wave superimposed on rated load (JEDEC method) | IFSM | 150 | | | | | | | | | Amps |
| Maximum instantaneous forward voltage at 10.0 A(Note 1) | VF | 0.60 | | 0.75 | | 0.85 | | 0.90 | 0.95 | | Volts |
| Maximum instantaneous reverse current at rated DC blocking voltage(Note 1) | TA = 25°C | 0.5 | | | | | | | | | mA |
| | TA = 125°C | 15 | | | 50 | | | | | | |
| Typical thermal resistance (Note 2) | RθJC | 2.5 | | | | | | | | | °C/W |
| Operating junction temperature range | TJ | -65 to+125 | | | -65 to+150 | | | | | | °C |
| Storage temperature range | TSTG | -65 to+150 | | | | | | | | | °C |

- Notes: 1.Pulse test: 300 μs pulse width,1% duty cycle
2.Thermal resistance from junction to case

RATINGS AND CHARACTERISTIC CURVES SRF1020 THRU SRF10200

FIG.1-FORWARD CURRENT DERATING CURVE

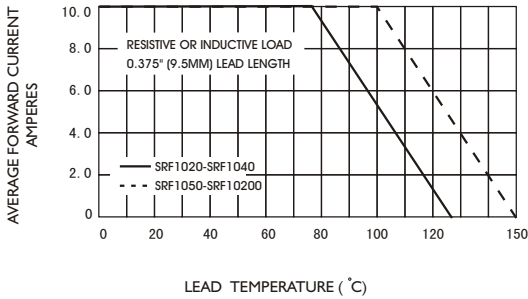

FIG.2-MAXIMUM NON-REPETITIVE PEAK FORWARD SURGE CURRENT

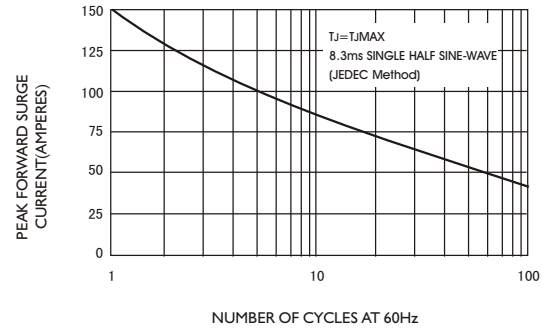

FIG.3-TYPICAL INSTANTANEOUS FORWARD CHARACTERISTICS

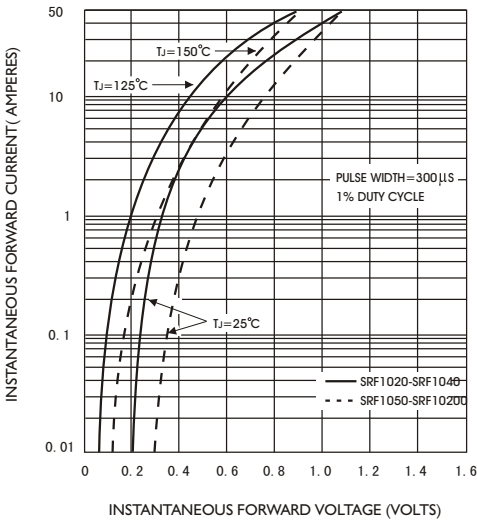

FIG.4-TYPICAL REVERSE CHARACTERISTICS

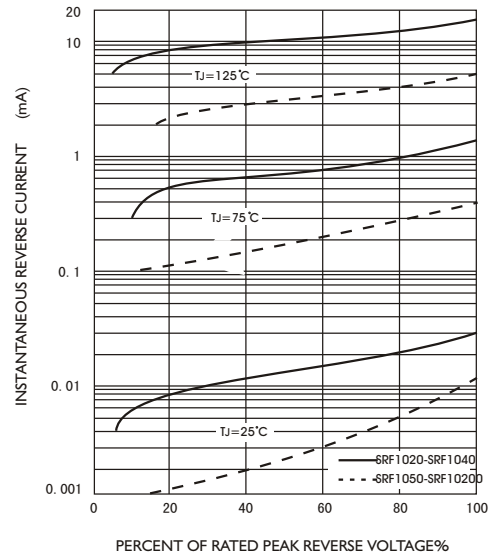

FIG.5-TYPICAL JUNCTION CAPACITANCE

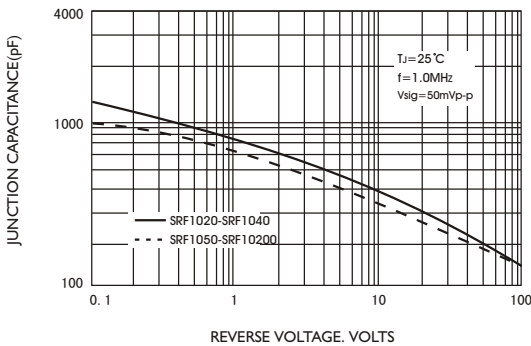

FIG.6-TYPICAL TRANSIENT THERMAL IMPEDANCE

