

Features

- Device is Bi-Directional
- Small Size and Low Profile
- Superior Repeatability
- Typical Insertion Loss 0.3 dB
- Typical Directivity 15 dB
- 2 Watt Power Handling
- SOIC-8 Package

Description

M/A-COM's CH20-0032-17G is an IC based monolithic bi-directional coupler in a low cost SO-8 plastic package. This 17 dB coupler is ideally suited for applications where power monitoring, small size, low insertion loss, superior repeatability, and low cost are required. Typical applications include base station switching networks, power monitoring in hand-holds and other communication applications where size and PCB real estate is a premium. Available in tape and reel.

The CH20-0032-17G is fabricated using a passive-integrated circuit process. The process features full chip passivation for increased performance and reliability.

Functional Block Diagram

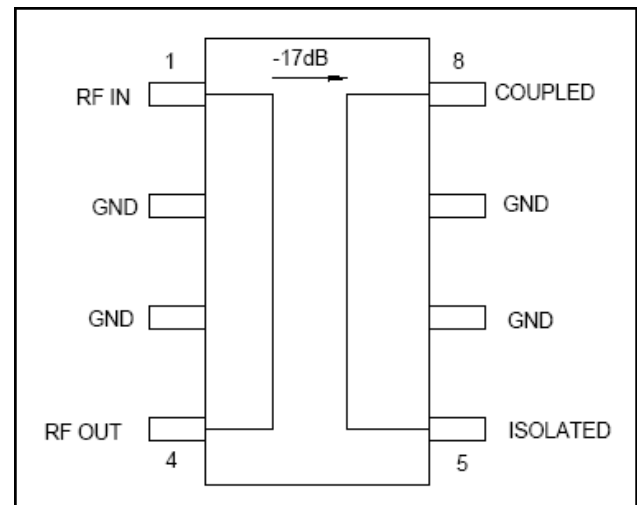

1. Pins 2, 3, 6, and 7 must be RF and DC grounded.

Ordering Information

Part Number	Package
CH20-0032-17G	Bulk Packaging
CH20-0032-17G-TR	1000 piece reel
CH20-0032-17GSAM	Sample Test Board

Note: Reference Application Note M513 for reel size information.

Pin Configuration

Pin No.	Function	Pin No.	Function
1	RF IN	5	ISOLATED
2	GND	6	GND
3	GND	7	GND
4	RF OUT	8	COUPLED

Electrical Specifications: $T_A = 25^\circ\text{C}$, $Z_0 = 50\Omega$ ¹

Parameter	Units	Min	Typ	Max
Insertion Loss	dB	—	0.3	0.5
VSWR	—	—	1.3:1	1.6:1
Coupling	dB	—	17±2	—
Coupling Flatness	dB	—	1.2	1.5
Directivity	dB	10	15	—

Absolute Maximum Ratings^{2,3}

Parameter	Absolute Maximum
Input Power	2W CW
Operating Temperature	-40°C to +85°C
Storage Temperature	-65°C to +150°C

- Exceeding any one or combination of these limits may cause permanent damage to this device.
- M/A-COM does not recommend sustained operation near these survivability limits.

Handling Procedures

Please observe the following precautions to avoid damage:

Static Sensitivity

GMIC Circuits are sensitive to electrostatic discharge (ESD) and can be damaged by static electricity. Proper ESD control techniques should be used when handling these devices.

Recommended PCB Configuration

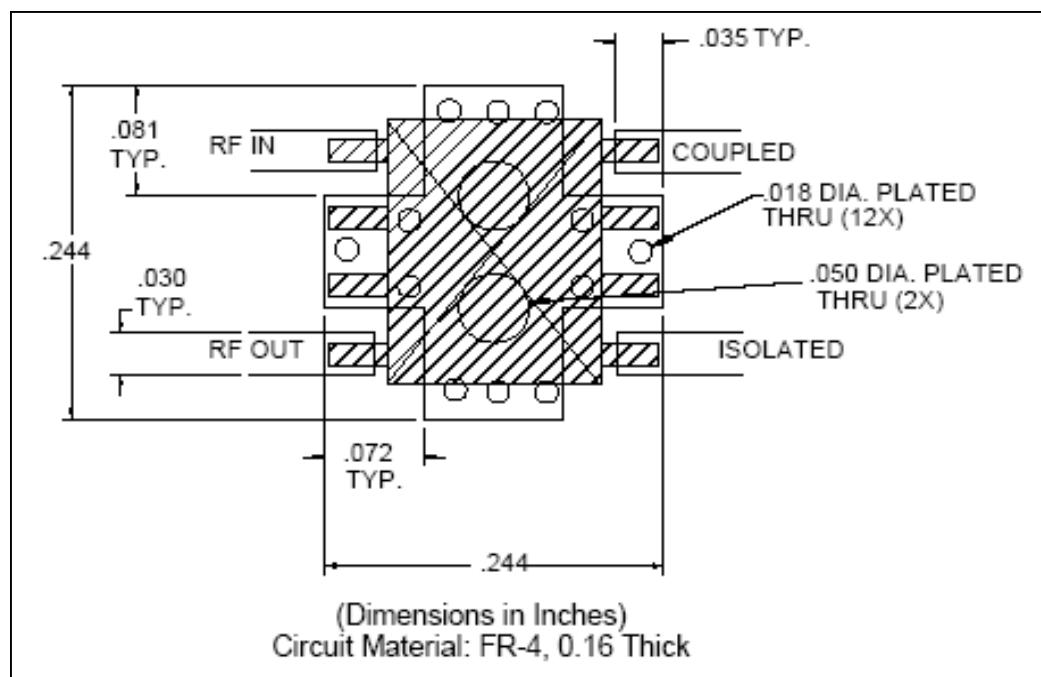

ADVANCED: Data Sheets contain information regarding a product M/A-COM Technology Solutions is considering for development. Performance is based on target specifications, simulated results, and/or prototype measurements. Commitment to develop is not guaranteed.
PRELIMINARY: Data Sheets contain information regarding a product M/A-COM Technology Solutions has under development. Performance is based on engineering tests. Specifications are typical. Mechanical outline has been fixed. Engineering samples and/or test data may be available. Commitment to produce in volume is not guaranteed.

• **North America** Tel: 800.366.2266 • **Europe** Tel: +353.21.244.6400
 • **India** Tel: +91.80.4155721 • **China** Tel: +86.21.2407.1588
 Visit www.macomtech.com for additional data sheets and product information.

M/A-COM Technology Solutions Inc. and its affiliates reserve the right to make changes to the product(s) or information contained herein without notice.

Typical Performance Curves @ +25°C

Directivity vs. Frequency

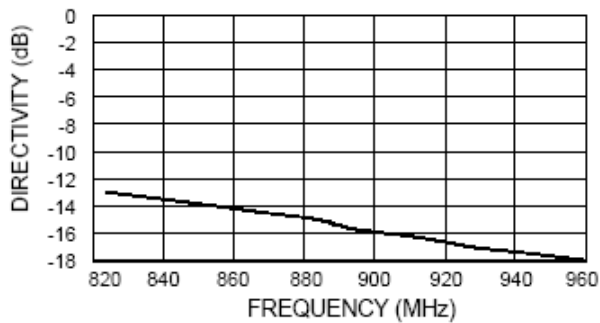

Insertion Loss vs. Frequency

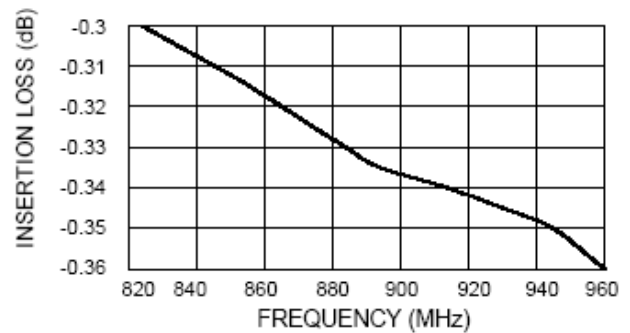

VSWR vs. Frequency

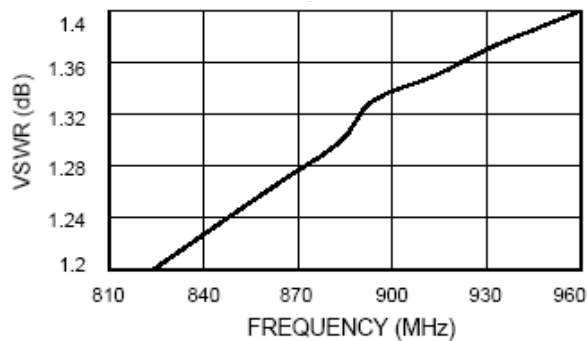

Coupling vs. Frequency

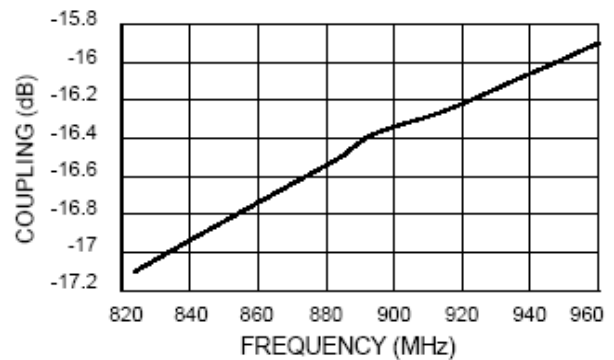

CH20-0032-17G

Low Cost SMT 17dB Bi-Directional Coupler
824 – 960 MHz

Rev. V3

SOIC-8[†]

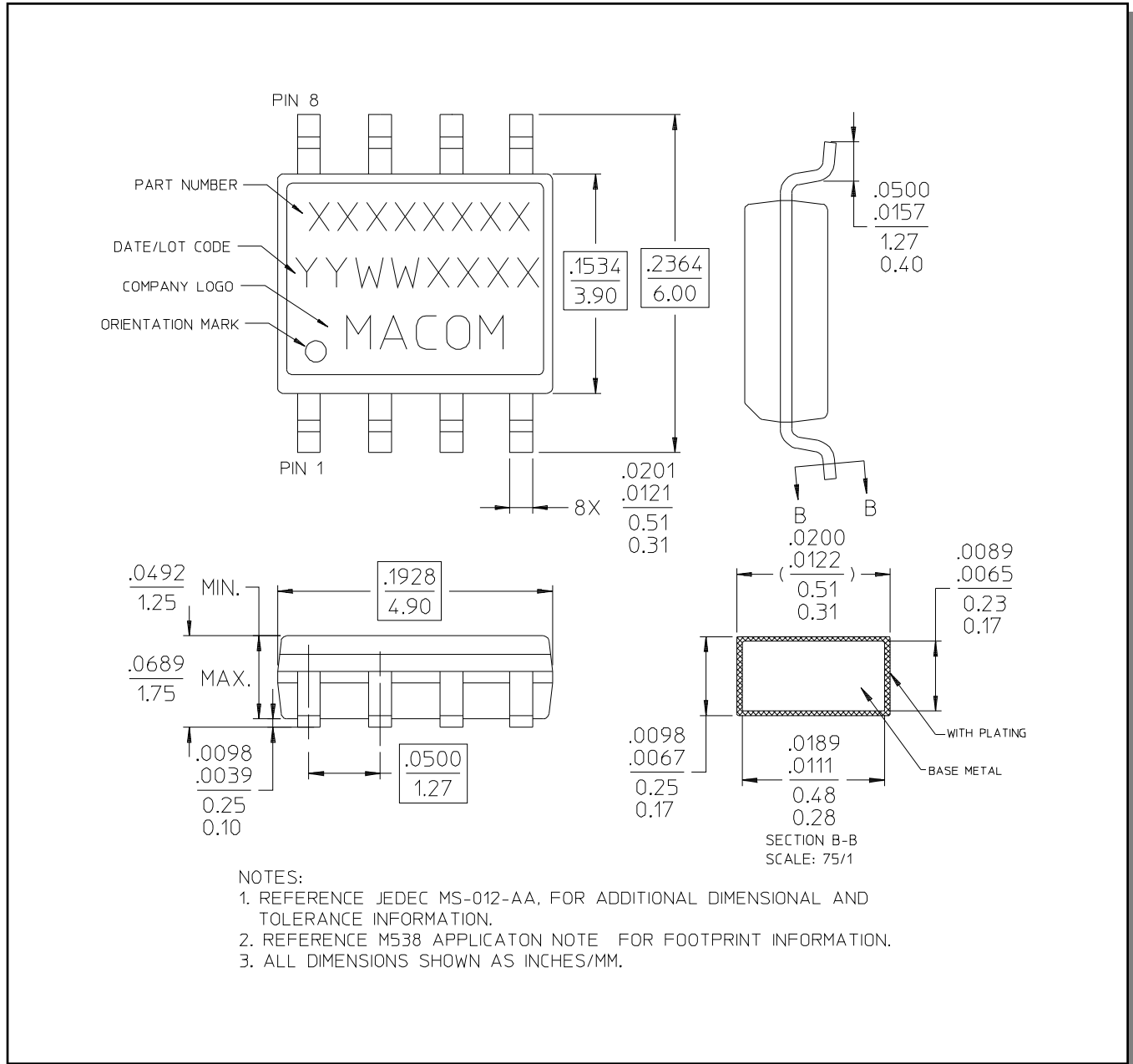

[†] Reference Application Note M538 for solder reflow recommendations.