

# 512Mb B-die DDR SDRAM Specification

60 FBGA

**INFORMATION IN THIS DOCUMENT IS PROVIDED IN RELATION TO SAMSUNG PRODUCTS, AND IS SUBJECT TO CHANGE WITHOUT NOTICE.**

**NOTHING IN THIS DOCUMENT SHALL BE CONSTRUED AS GRANTING ANY LICENSE, EXPRESS OR IMPLIED, BY ESTOPPEL OR OTHERWISE,**

**TO ANY INTELLECTUAL PROPERTY RIGHTS IN SAMSUNG PRODUCTS OR TECHNOLOGY. ALL INFORMATION IN THIS DOCUMENT IS PROVIDED**

**ON AS "AS IS" BASIS WITHOUT GUARANTEE OR WARRANTY OF ANY KIND.**

1. For updates or additional information about Samsung products, contact your nearest Samsung office.
2. Samsung products are not intended for use in life support, critical care, medical, safety equipment, or similar applications where Product failure could result in loss of life or personal or physical harm, or any military or defense application, or any governmental procurement to which special terms or provisions may apply.

\* Samsung Electronics reserves the right to change products or specification without notice.

**Table of Contents**

1.0 Key Features ..... 4

2.0 Ordering Information ..... 4

3.0 Operating Frequencies..... 4

4.0 Pin Description ..... 5

5.0 Package Physical Dimension ..... 6

6.0 Block Diagram (32Mbit x4 / 16Mbit x8 / 8Mbit x16 I/O x4 Banks)..... 7

7.0 Input/Output Function Description ..... 8

8.0 Command Truth Table..... 9

9.0 General Description..... 10

10.0 Absolute Maximum Rating ..... 10

11.0 DC Operating Conditions ..... 10

12.0 DDR SDRAM Spec Items & Test Conditions ..... 11

13.0 Input/Output Capacitance ..... 11

14.0 Detailed test condition for DDR SDRAM IDD1 & IDD7A ..... 12

15.0 DDR SDRAM IDD spec table ..... 13

16.0 AC Operating Conditions ..... 14

17.0 AC Overshoot/Undershoot specification for Address and Control Pins ..... 14

18.0 Overshoot/Undershoot specification for Data, Strobe and Mask Pins..... 15

19.0 AC Timing Parameters & Specifications ..... 16

20.0 System Characteristics for DDR SDRAM ..... 17

21.0 Component Notes..... 18

22.0 System Notes ..... 20

23.0 IBIS : I/V Characteristics for Input and Output Buffers ..... 21

**Revision History**

| Revision | Month     | Year | History                             |
|----------|-----------|------|-------------------------------------|
| 0.0      | September | 2003 | - First version for internal review |
| 1.0      | October   | 2003 | - updated DC Characteristics        |
| 1.1      | May       | 2004 | - Corrected typo.                   |
| 1.2      | October   | 2004 | - Corrected typo                    |
| 1.3      | June      | 2005 | - Changed master format.            |

## 1.0 Key Features

- VDD : 2.5V ± 0.2V, VDDQ : 2.5V ± 0.2V for DDR333
- VDD : 2.6V ± 0.1V, VDDQ : 2.6V ± 0.1V for DDR400
- Double-data-rate architecture; two data transfers per clock cycle
- Bidirectional data strobe [DQS] (x4,x8) & [L(U)DQS] (x16)
- Four banks operation
- Differential clock inputs(CK and  $\overline{CK}$ )
- DLL aligns DQ and DQS transition with CK transition
- MRS cycle with address key programs
  - Read latency : DDR333(2.5 Clock), DDR400(3 Clock)
  - Burst length (2, 4, 8)
  - Burst type (sequential & interleave)
- All inputs except data & DM are sampled at the positive going edge of the system clock(CK)
- Data I/O transactions on both edges of data strobe
- Edge aligned data output, center aligned data input
- LDM,UDM for write masking only (x16)
- DM for write masking only (x4, x8)
- Auto & Self refresh
- 7.8us refresh interval(8K/64ms refresh)
- Maximum burst refresh cycle : 8
- 60Ball FBGA (**Leaded & Pb-Free(RoHS compliant)**) package

## 2.0 Ordering Information

| Part No.             | Org.     | Max Freq.         | Interface | Package     |
|----------------------|----------|-------------------|-----------|-------------|
| K4H510438B-G(Z)C/LCC | 128M x 4 | CC(DDR400@CL=3)   | SSTL2     | 60ball FBGA |
| K4H510438B-G(Z)C/LB3 |          | B3(DDR333@CL=2.5) |           |             |
| K4H510438B-G(Z)C/LA2 |          | A2(DDR266@CL=2)   |           |             |
| K4H510438B-G(Z)C/LB0 |          | B0(DDR266@CL=2.5) |           |             |
| K4H510838B-G(Z)C/LCC | 64M x 8  | CC(DDR400@CL=3)   | SSTL2     | 60ball FBGA |
| K4H510838B-G(Z)C/LB3 |          | B3(DDR333@CL=2.5) |           |             |
| K4H510838B-G(Z)C/LA2 |          | A2(DDR266@CL=2)   |           |             |
| K4H510838B-G(Z)C/LB0 |          | B0(DDR266@CL=2.5) |           |             |
| K4H511638B-G(Z)C/LCC | 32M x 16 | CC(DDR400@CL=3)   | SSTL2     | 60ball FBGA |
| K4H511638B-G(Z)C/LB3 |          | B3(DDR333@CL=2.5) |           |             |
| K4H511638B-G(Z)C/LA2 |          | A2(DDR266@CL=2)   |           |             |
| K4H511638B-G(Z)C/LB0 |          | B0(DDR266@CL=2.5) |           |             |

Note : Leaded and Lead-free(Pb-free) can be discriminated by PKG P/N (G : 60 FBGA with Leaded, Z : 60 FBGA with Lead-free)

## 3.0 Operating Frequencies

|              | CC(DDR400@CL=3) | B3(DDR333@CL=2.5) |
|--------------|-----------------|-------------------|
| Speed @CL2   | -               | 133MHz            |
| Speed @CL2.5 | 166MHz          | 166MHz            |
| Speed @CL3   | 200MHz          | -                 |
| CL-tRCD-tRP  | 3-3-3           | 2.5-3-3           |

4.0 Ball Description (Bottom View)

128M x 4

|   |          |          |          |          |          |          |                  |                  |          |          |          |          |
|---|----------|----------|----------|----------|----------|----------|------------------|------------------|----------|----------|----------|----------|
| 1 | VSSQ     | NC       | NC       | NC       | NC       | VREF     |                  |                  |          |          |          |          |
| 2 | NC       | VDDQ     | VSSQ     | VDDQ     | VSSQ     | VSS      | CK               | A12              | A11      | A8       | A6       | A4       |
| 3 | VSS      | DQ3      | NC       | DQ2      | DQS      | DM       | $\overline{CK}$  | CKE              | A9       | A7       | A5       | VSS      |
|   | <b>A</b> | <b>B</b> | <b>C</b> | <b>D</b> | <b>E</b> | <b>F</b> | <b>G</b>         | <b>H</b>         | <b>J</b> | <b>K</b> | <b>L</b> | <b>M</b> |
| 7 | VDD      | DQ0      | NC       | DQ1      | NC       | NC       | $\overline{WE}$  | $\overline{RAS}$ | BA1      | A0       | A2       | VDD      |
| 8 | NC       | VSSQ     | VDDQ     | VSSQ     | VDDQ     | VDD      | $\overline{CAS}$ | $\overline{CS}$  | BA0      | A10/AP   | A1       | A3       |
| 9 | VDDQ     | NC       | NC       | NC       | NC       | NC       |                  |                  |          |          |          |          |

64M x 8

|   |          |          |          |          |          |          |                  |                  |          |          |          |          |
|---|----------|----------|----------|----------|----------|----------|------------------|------------------|----------|----------|----------|----------|
| 1 | VSSQ     | NC       | NC       | NC       | NC       | VREF     |                  |                  |          |          |          |          |
| 2 | DQ7      | VDDQ     | VSSQ     | VDDQ     | VSSQ     | VSS      | CK               | A12              | A11      | A8       | A6       | A4       |
| 3 | VSS      | DQ6      | DQ5      | DQ4      | DQS      | DM       | $\overline{CK}$  | CKE              | A9       | A7       | A5       | VSS      |
|   | <b>A</b> | <b>B</b> | <b>C</b> | <b>D</b> | <b>E</b> | <b>F</b> | <b>G</b>         | <b>H</b>         | <b>J</b> | <b>K</b> | <b>L</b> | <b>M</b> |
| 7 | VDD      | DQ1      | DQ2      | DQ3      | NC       | NC       | $\overline{WE}$  | $\overline{RAS}$ | BA1      | A0       | A2       | VDD      |
| 8 | DQ0      | VSSQ     | VDDQ     | VSSQ     | VDDQ     | VDD      | $\overline{CAS}$ | $\overline{CS}$  | BA0      | A10/AP   | A1       | A3       |
| 9 | VDDQ     | NC       | NC       | NC       | NC       | NC       |                  |                  |          |          |          |          |

32M x 16

|   |          |          |          |          |          |          |                  |                  |          |          |          |          |
|---|----------|----------|----------|----------|----------|----------|------------------|------------------|----------|----------|----------|----------|
| 1 | VSSQ     | DQ14     | DQ12     | DQ10     | DQ8      | VREF     |                  |                  |          |          |          |          |
| 2 | DQ15     | VDDQ     | VSSQ     | VDDQ     | VSSQ     | VSS      | CK               | A12              | A11      | A8       | A6       | A4       |
| 3 | VSS      | DQ13     | DQ11     | DQ9      | UDQS     | UDM      | $\overline{CK}$  | CKE              | A9       | A7       | A5       | VSS      |
|   | <b>A</b> | <b>B</b> | <b>C</b> | <b>D</b> | <b>E</b> | <b>F</b> | <b>G</b>         | <b>H</b>         | <b>J</b> | <b>K</b> | <b>L</b> | <b>M</b> |
| 7 | VDD      | DQ2      | DQ4      | DQ6      | LDQS     | LDM      | $\overline{WE}$  | $\overline{RAS}$ | BA1      | A0       | A2       | VDD      |
| 8 | DQ0      | VSSQ     | VDDQ     | VSSQ     | VDDQ     | VDD      | $\overline{CAS}$ | $\overline{CS}$  | BA0      | A10/AP   | A1       | A3       |
| 9 | VDDQ     | DQ1      | DQ3      | DQ5      | DQ7      | NC       |                  |                  |          |          |          |          |

| Organization | Row Address | Column Address  |
|--------------|-------------|-----------------|
| 128Mx4       | A0~A12      | A0-A9, A11, A12 |
| 64Mx8        | A0~A12      | A0-A9, A11      |
| 32Mx16       | A0~A12      | A0-A9           |

DM is internally loaded to match DQ and DQS identically.

Row & Column address configuration

5.0 Package Physical Dimension

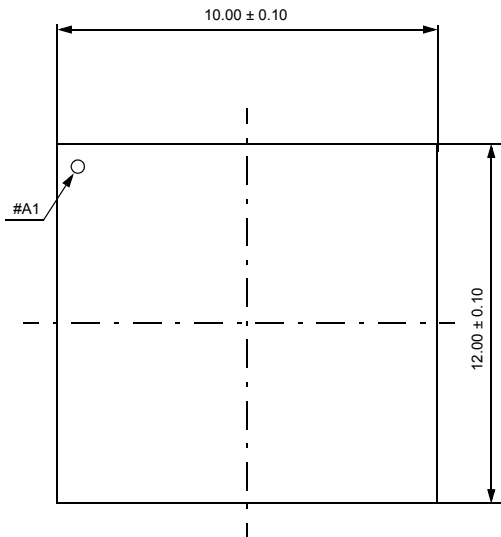

Top view

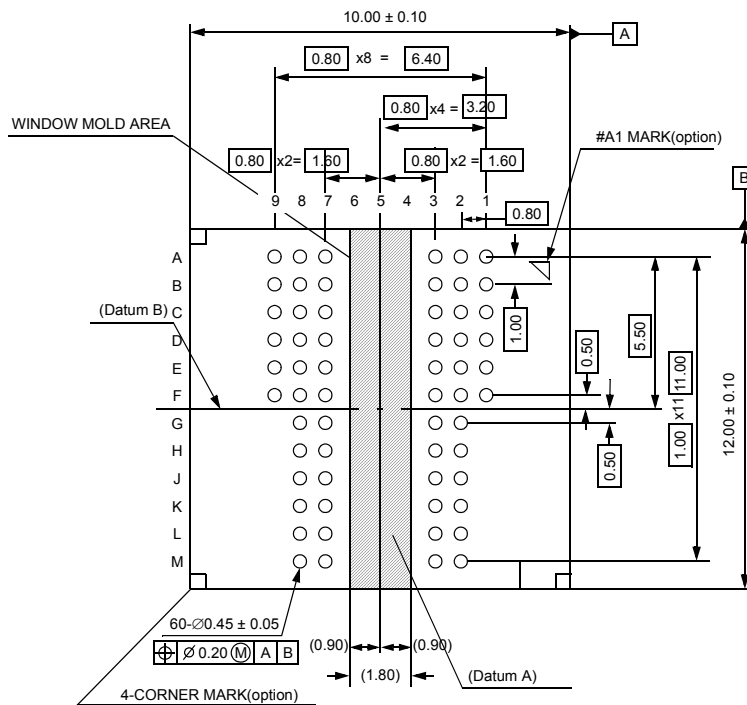
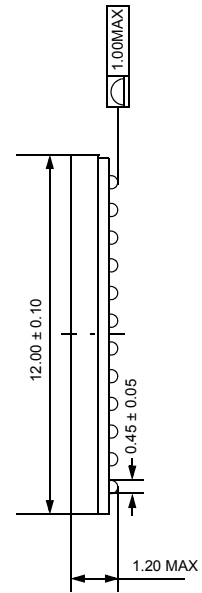

Bottom view

60Ball FBGA 512Mb Package Dimension

6.0 Block Diagram (32Mb x 4 / 16Mb x 8 / 8Mb x 16 I/O x4 Banks)

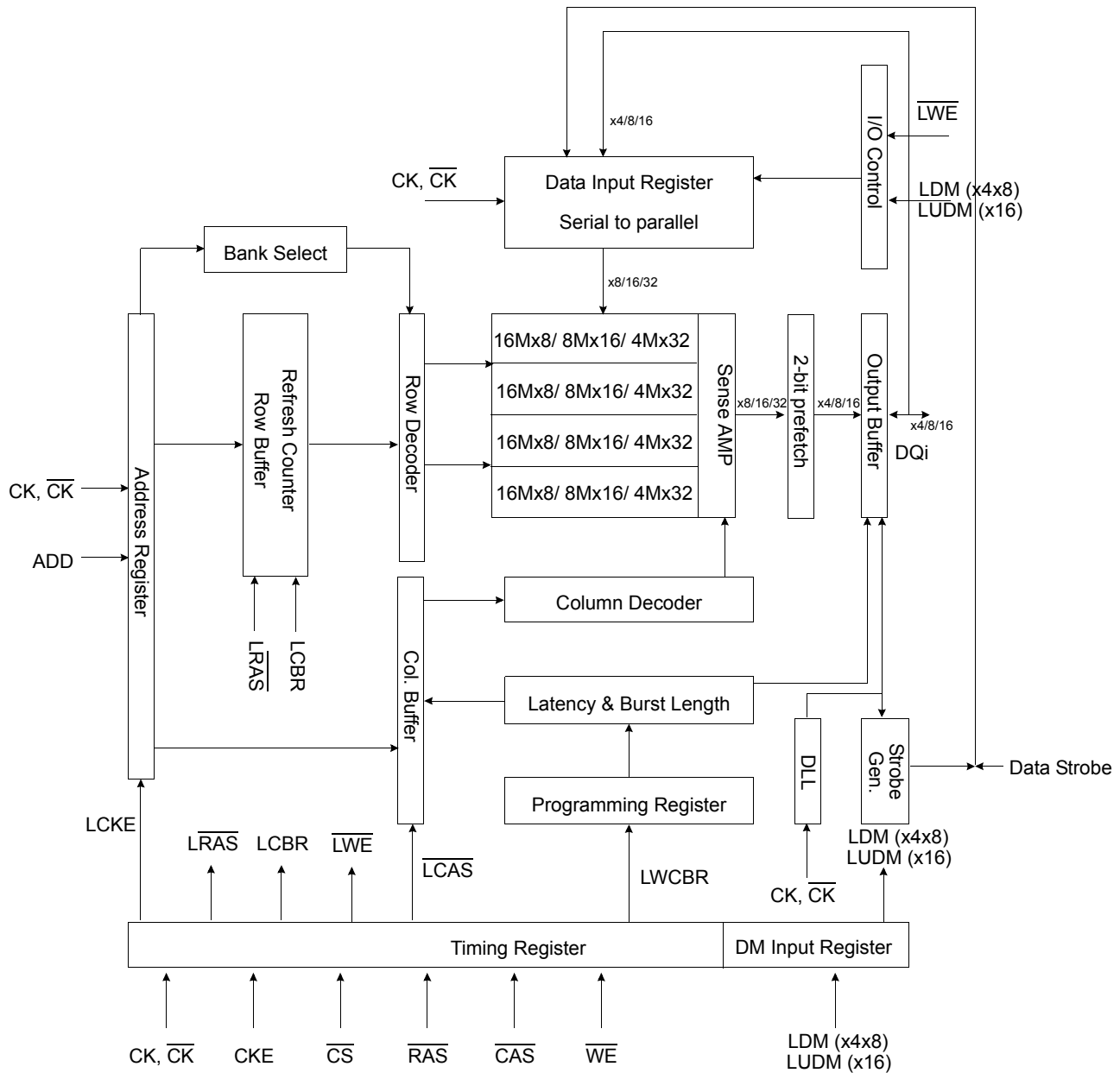

## 7.0 Input/Output Function Description

| SYMBOL  | TYPE   | DESCRIPTION  |
|---|--------|--|
| CK, $\overline{CK}$                                   | Input  | Clock : CK and $\overline{CK}$ are differential clock inputs. All address and control input signals are sampled on the positive edge of CK and negative edge of $\overline{CK}$ . Output (read) data is referenced to both edges of CK. Internal clock signals are derived from CK/CK.   |
| CKE   | Input  | Clock Enable : CKE HIGH activates, and CKE LOW deactivates internal clock signals, and device input buffers and output drivers. Taking CKE Low provides PRECHARGE POWER-DOWN and SELF REFRESH operation (all banks idle), or ACTIVE POWER-DOWN (row ACTIVE in any bank). CKE is synchronous for POWER-DOWN entry and exit, and for SELF REFRESH entry. CKE is asynchronous for SELF REFRESH exit, and for output disable. CKE must be maintained high throughout READ and WRITE accesses. Input buffers, excluding CK, $\overline{CK}$ and CKE are disabled during POWER-DOWN. Input buffers, excluding CKE are disabled during SELF REFRESH. CKE is an SSTL_2 input, but will detect an LVCMOS Low level after Vdd is applied upon 1st power up, After $V_{REF}$ has become stable during the power on and initialization sequence, it must be maintained for proper operation of the CKE receiver. For proper SELF-REFRESH entry and exit, $V_{REF}$ must be maintained to this input. |
| $\overline{CS}$                                       | Input  | Chip Select : $\overline{CS}$ enables (registered LOW) and disables (registered HIGH) the command decoder. All commands are masked when $\overline{CS}$ is registered HIGH. $\overline{CS}$ provides for external bank selection on systems with multiple banks. $\overline{CS}$ is considered part of the command code.   |
| $\overline{RAS}$ , $\overline{CAS}$ , $\overline{WE}$ | Input  | Command Inputs : $\overline{RAS}$ , $\overline{CAS}$ and $\overline{WE}$ (along with $\overline{CS}$ ) define the command being entered.   |
| LDM, (UDM)  | Input  | Input Data Mask : DM is an input mask signal for write data. Input data is masked when DM is sampled HIGH along with that input data during a WRITE access. DM is sampled on both edges of DQS. Although DM pins are input only, the DM loading matches the DQ and DQS loading. For the x16, LDM corresponds to the data on DQ0~D7 ; UDM corresponds to the data on DQ8~DQ15. DM may be driven high, low, or floating during READS.  |
| BA0, BA1  | Input  | Bank Address Inputs : BA0 and BA1 define to which bank an ACTIVE, READ, WRITE or PRECHARGE command is being applied.   |
| A [0 : 12]  | Input  | Address Inputs : Provide the row address for ACTIVE commands, and the column address and AUTO PRECHARGE bit for READ/WRITE commands, to select one location out of the memory array in the respective bank. A10 is sampled during a PRECHARGE command to determine whether the PRECHARGE applies to one bank (A10 LOW) or all banks (A10 HIGH). If only one bank is to be precharged, the bank is selected by BA0, BA1. The address inputs also provide the op-code during a MODE REGISTER SET command. BA0 and BA1 define which mode register is loaded during the MODE REGISTER SET command (MRS or EMRS).   |
| DQ  | I/O    | Data Input/Output : Data bus   |
| LDQS, (U)DQS  | I/O    | Data Strobe : Output with read data, input with write data. Edge-aligned with read data, centered in write data. Used to capture write data. For the x16, LDQS corresponds to the data on DQ0~D7 ; UDQS corresponds to the data on DQ8~DQ15  |
| NC  | -      | No Connect : No internal electrical connection is present.   |
| VDDQ  | Supply | DQ Power Supply : +2.5V $\pm$ 0.2V. (+2.6V $\pm$ 0.1V for DDR400)  |
| VSSQ  | Supply | DQ Ground.   |
| VDD   | Supply | Power Supply : +2.5V $\pm$ 0.2V. (+2.6V $\pm$ 0.1V for DDR400)   |
| VSS   | Supply | Ground.  |
| VREF  | Input  | SSTL_2 reference voltage.  |



8.0 Command Truth Table

(V=Valid, X=Don't Care, H=Logic High, L=Logic Low)

| COMMAND                          |                        | CKEn-1 | CKEn  | $\overline{CS}$ | $\overline{RAS}$ | $\overline{CAS}$ | $\overline{WE}$ | BA0,1   | A10/AP      | A0 ~ A9,<br>A11 ~ A12 | Note |      |
|----------------------------------|------------------------|--------|-------|-----------------|------------------|------------------|-----------------|---------|-------------|-----------------------|------|------|
| Register                         | Extended MRS           | H      | X     | L               | L                | L                | L               | OP CODE |             |                       | 1, 2 |      |
| Register                         | Mode Register Set      | H      | X     | L               | L                | L                | L               | OP CODE |             |                       | 1, 2 |      |
| Refresh                          | Auto Refresh           | H      | H     | L               | L                | L                | H               | X       |             |                       | 3    |      |
|                                  |                        |        | Entry |                 |                  |                  |                 |         |             | L                     |      | 3    |
|                                  | Self Refresh           | L      | H     | L               | H                | H                | H               | X       |             |                       | 3    |      |
|                                  |                        |        |       | Exit            | H                | X                | X               |         |             | X                     |      | 3    |
| Bank Active & Row Addr.          |                        | H      | X     | L               | L                | H                | H               | V       | Row Address |                       |      |      |
| Read & Column Address            | Auto Precharge Disable | H      | X     | L               | H                | L                | H               | V       | L           | Column Address        |      | 4    |
|                                  | Auto Precharge Enable  |        |       |                 |                  |                  |                 |         | H           |                       |      | 4    |
| Write & Column Address           | Auto Precharge Disable | H      | X     | L               | H                | L                | L               | V       | L           | Column Address        |      | 4    |
|                                  | Auto Precharge Enable  |        |       |                 |                  |                  |                 |         | H           |                       |      | 4, 6 |
| Burst Stop                       |                        | H      | X     | L               | H                | H                | L               | X       |             |                       | 7    |      |
| Precharge                        | Bank Selection         | H      | X     | L               | L                | H                | L               | V       | L           | X                     |      |      |
|                                  | All Banks              |        |       |                 |                  |                  |                 | X       | H           |                       |      | 5    |
| Active Power Down                | Entry                  | H      | L     | H               | X                | X                | X               | X       |             |                       |      |      |
|                                  |                        |        |       | L               | V                | V                | V               |         |             |                       |      |      |
| Precharge Power Down Mode        | Entry                  | H      | L     | H               | X                | X                | X               | X       |             |                       |      |      |
|                                  |                        |        |       | L               | H                | H                | H               |         |             |                       |      |      |
|                                  | Exit                   | L      | H     | H               | X                | X                | X               |         |             |                       |      |      |
|                                  |                        |        |       | L               | V                | V                | V               |         |             |                       |      |      |
| DM(UDM/LDM for x16 only)         |                        | H      |       | X               |                  |                  |                 | X       |             |                       | 8    |      |
| No operation (NOP) : Not defined |                        | H      | X     | H               | X                | X                | X               | X       |             |                       | 9    |      |
|                                  |                        |        |       | L               | H                | H                | H               |         |             |                       | 9    |      |

Note :

- OP Code : Operand Code. A0 ~ A13& BA0 ~ BA1 : Program keys. (@EMRS/MRS)
- EMRS/MRS can be issued only at all banks precharge state.  
A new command can be issued 2 clock cycles after EMRS or MRS.
- Auto refresh functions are same as the CBR refresh of DRAM.  
The automatical precharge without row precharge command is meant by "Auto".  
Auto/self refresh can be issued only at all banks precharge state.
- BA0 ~ BA1 : Bank select addresses.  
If both BA0 and BA1 are "Low" at read, write, row active and precharge, bank A is selected.  
If BA0 is "High" and BA1 is "Low" at read, write, row active and precharge, bank B is selected.  
If BA0 is "Low" and BA1 is "High" at read, write, row active and precharge, bank C is selected.  
If both BA0 and BA1 are "High" at read, write, row active and precharge, bank D is selected.
- If A10/AP is "High" at row precharge, BA0 and BA1 are ignored and all banks are selected.
- During burst write with auto precharge, new read/write command can not be issued.  
Another bank read/write command can be issued after the end of burst.  
New row active of the associated bank can be issued at tRP after the end of burst.
- Burst stop command is valid at every burst length.
- DM(x4/8) sampled at the rising and falling edges of the DQS and Data-in are masked at the both edges (Write DM latency is 0).  
UDM/LDM(x16 only) sampled at the rising and falling edges of the UDQS/LDQS and Data-in are masked at the both edges (Write UDM/LDM latency is 0).
- This combination is not defined for any function, which means "No Operation(NOP)" in DDR SDRAM.

32M x 4Bit x 4 Banks / 16M x 8Bit x 4 Banks / 8M x 16Bit x 4 Banks Double Data Rate SDRAM

### 9.0 General Description

The K4H510438B / K4H510838B / K4H511638B is 536,870,912 bits of double data rate synchronous DRAM organized as 4x 33,554,432 / 4x 16,777,216 / 4x 8,388,608 words by 4/8/16bits, fabricated with SAMSUNG's high performance CMOS technology. Synchronous features with Data Strobe allow extremely high performance up to 400Mb/s per pin. I/O transactions are possible on both edges of DQS. Range of operating frequencies, programmable burst length and programmable latencies allow the device to be useful for a variety of high performance memory system applications.

### 10.0 Absolute Maximum Rating

| Parameter  | Symbol                             | Value      | Unit |
|--|------------------------------------|------------|------|
| Voltage on any pin relative to V <sub>SS</sub>                                   | V <sub>IN</sub> , V <sub>OUT</sub> | -0.5 ~ 3.6 | V    |
| Voltage on V <sub>DD</sub> & V <sub>DDQ</sub> supply relative to V <sub>SS</sub> | V <sub>DD</sub> , V <sub>DDQ</sub> | -1.0 ~ 3.6 | V    |
| Storage temperature  | T <sub>STG</sub>                   | -55 ~ +150 | °C   |
| Power dissipation  | P <sub>D</sub>                     | 1.5        | W    |
| Short circuit current  | I <sub>OS</sub>                    | 50         | mA   |

Note : Permanent device damage may occur if ABSOLUTE MAXIMUM RATINGS are exceeded.  
 Functional operation should be restricted to recommend operation condition.  
 Exposure to higher than recommended voltage for extended periods of time could affect device reliability.

### 11.0 DC Operating Conditions Recommended operating conditions(Voltage referenced to V<sub>SS</sub>=0V, T<sub>A</sub>=0 to 70°C)

| Parameter  | Symbol                 | Min                    | Max                    | Unit | Note |
|--|------------------------|------------------------|------------------------|------|------|
| Supply voltage(for device with a nominal V <sub>DD</sub> of 2.5V for DDR266/333)         | V <sub>DD</sub>        | 2.3                    | 2.7                    |      |      |
| Supply voltage(for device with a nominal V <sub>DD</sub> of 2.6V for DDR400)             | V <sub>DD</sub>        | 2.5                    | 2.7                    |      |      |
| I/O Supply voltage(for device with a nominal V <sub>DD</sub> of 2.5V for DDR266/333)     | V <sub>DDQ</sub>       | 2.3                    | 2.7                    | V    |      |
| I/O Supply voltage(for device with a nominal V <sub>DD</sub> of 2.5V for DDR400)         | V <sub>DDQ</sub>       | 2.5                    | 2.7                    |      |      |
| I/O Reference voltage  | V <sub>REF</sub>       | 0.49*V <sub>DDQ</sub>  | 0.51*V <sub>DDQ</sub>  | V    | 1    |
| I/O Termination voltage(system)  | V <sub>TT</sub>        | V <sub>REF</sub> -0.04 | V <sub>REF</sub> +0.04 | V    | 2    |
| Input logic high voltage   | V <sub>IH</sub> (DC)   | V <sub>REF</sub> +0.15 | V <sub>DDQ</sub> +0.3  | V    |      |
| Input logic low voltage  | V <sub>IL</sub> (DC)   | -0.3                   | V <sub>REF</sub> -0.15 | V    |      |
| Input Voltage Level, CK and $\overline{\text{CK}}$ inputs                                | V <sub>IN</sub> (DC)   | -0.3                   | V <sub>DDQ</sub> +0.3  | V    |      |
| Input Differential Voltage, CK and $\overline{\text{CK}}$ inputs                         | V <sub>ID</sub> (DC)   | 0.36                   | V <sub>DDQ</sub> +0.6  | V    | 3    |
| V-I Matching: Pullup to Pulldown Current Ratio   | V <sub>I</sub> (Ratio) | 0.71                   | 1.4                    | -    | 4    |
| Input leakage current  | I <sub>I</sub>         | -2                     | 2                      | uA   |      |
| Output leakage current   | I <sub>OZ</sub>        | -5                     | 5                      | uA   |      |
| Output High Current(Normal strength driver) ; V <sub>OUT</sub> = V <sub>TT</sub> + 0.84V | I <sub>OH</sub>        | -16.8                  |                        | mA   |      |
| Output High Current(Normal strength driver) ; V <sub>OUT</sub> = V <sub>TT</sub> - 0.84V | I <sub>OL</sub>        | 16.8                   |                        | mA   |      |
| Output High Current(Half strength driver) ; V <sub>OUT</sub> = V <sub>TT</sub> + 0.45V   | I <sub>OH</sub>        | -9                     |                        | mA   |      |
| Output High Current(Half strength driver) ; V <sub>OUT</sub> = V <sub>TT</sub> - 0.45V   | I <sub>OL</sub>        | 9                      |                        | mA   |      |

- Note :
- V<sub>REF</sub> is expected to be equal to 0.5\*V<sub>DDQ</sub> of the transmitting device, and to track variations in the dc level of same. Peak-to-peak noise on V<sub>REF</sub> may not exceed +/-2% of the dc value.
  - V<sub>TT</sub> is not applied directly to the device. V<sub>TT</sub> is a system supply for signal termination resistors, is expected to be set equal to V<sub>REF</sub>, and must track variations in the DC level of V<sub>REF</sub>
  - V<sub>ID</sub> is the magnitude of the difference between the input level on CK and the input level on  $\overline{\text{CK}}$ .
  - The ratio of the pullup current to the pulldown current is specified for the same temperature and voltage, over the entire temperature and voltage range, for device drain to source voltages from 0.25V to 1.0V. For a given output, it represents the maximum difference between pullup and pulldown drivers due to process variation. The full variation in the ratio of the maximum to minimum pullup and pulldown current will not exceed 1.7 for device drain to source voltages from 0.1 to 1.0.

12.0 DDR SDRAM Spec Items & Test Conditions

| Conditions  | Symbol |
|---|--------|
| <b>Operating current - One bank Active-Precharge;</b><br>tRC=tRCmin; tCK=10ns for DDR200, tCK=7.5ns for DDR266, 6ns for DDR333, 5ns for DDR400;<br>DQ,DM and DQS inputs changing once per clock cycle;<br>address and control inputs changing once every two clock cycles.  | IDD0   |
| <b>Operating current - One bank operation ;</b> One bank open, BL=4, Reads<br>- Refer to the following page for detailed test condition   | IDD1   |
| <b>Precharge power-down standby current;</b> All banks idle; power - down mode;<br>CKE = <VIL(max); tCK=10ns for DDR200,tCK=7.5ns for DDR266, 6ns for DDR333, 5ns for DDR400;<br>Vin = Vref for DQ,DQS and DM.  | IDD2P  |
| <b>Precharge Floating standby current;</b> CS# > =VIH(min);All banks idle; CKE > = VIH(min); tCK=10ns for<br>DDR200,tCK=7.5ns for DDR266, 6ns for DDR333, 5ns for DDR400; Address and other control inputs changing<br>once per clock cycle; Vin = Vref for DQ,DQS and DM   | IDD2F  |
| <b>Precharge Quiet standby current;</b> CS# > = VIH(min); All banks idle;<br>CKE > = VIH(min); tCK=10ns for DDR200, tCK=7.5ns for DDR266, 6ns for DDR333, 5ns for DDR400; Address and<br>other control inputs stable at >= VIH(min) or <=VIL(max); Vin = Vref for DQ ,DQS and DM  | IDD2Q  |
| <b>Active power - down standby current ;</b> one bank active; power-down mode;<br>CKE=< VIL (max); tCK=10ns for DDR200,tCK=7.5ns for DDR266, 6ns for DDR333, 5ns for DDR400;<br>Vin = Vref for DQ,DQS and DM  | IDD3P  |
| <b>Active standby current;</b> CS# >= VIH(min); CKE>=VIH(min);<br>one bank active; active - precharge; tRC=tRASmax; tCK=10ns for DDR200,tCK=7.5ns for DDR266, 6ns for<br>DDR333, 5ns for DDR400; DQ, DQS and DM inputs changing twice per clock cycle; address and other control<br>inputs changing once per clock cycle  | IDD3N  |
| <b>Operating current - burst read;</b> Burst length = 2; reads; contiguous burst; One bank active; address and control<br>inputs changing once per clock cycle; CL=2 at tCK=10ns for DDR200, CL=2 at 7.5ns for DDR266(A2), CL=2.5 at<br>tCK=7.5ns for DDR266(B0), tCK=6ns for DDR333, CL=3 at tCK=5ns for DDR400; 50% of data changing on every<br>transfer; Iout = 0 mA                                  | IDD4R  |
| <b>Operating current - burst write;</b> Burst length = 2; writes; continuous burst;<br>One bank active address and control inputs changing once per clock cycle; CL=2 at tCK=10ns for DDR200, CL=2<br>at tCK=7.5ns for DDR266(A2), CL=2.5 at tCK=7.5ns for DDR266(B0), 6ns for DDR333, 5ns for DDR400; DQ, DM<br>and DQS inputs changing twice per clock cycle, 50% of input data changing at every burst | IDD4W  |
| <b>Auto refresh current;</b> tRC = tRFC(min) which is 12*tCK for DDR200 at tCK=10ns; 16*tCK for DDR266 at<br>tCK=7.5ns; 20*tCK for DDR333 at tCK=6ns, 24*tCK for DDR400 at tCK=5ns; distributed refresh   | IDD5   |
| <b>Self refresh current;</b> CKE =< 0.2V; External clock on; tCK=10ns for DDR200, tCK=7.5ns for DDR266, 6ns for<br>DDR333, 5ns for DDR400.  | IDD6   |
| <b>Operating current - Four bank operation ;</b> Four bank interleaving with BL=4<br>-Refer to the following page for detailed test condition   | IDD7A  |

13.0 Input/Output Capacitance

( TA= 25°C, f=100MHz)

| Parameter  | Symbol | Min | Max | DeltaCap(max) | Unit | Note    |
|--|--------|-----|-----|---------------|------|---------|
| Input capacitance<br>(A0 ~ A12, BA0 ~ BA1, CKE, CS, RAS,CAS, WE) | CIN1   | 1.5 | 2.5 | 0.5           | pF   | 4       |
| Input capacitance( CK, CK )                                      | CIN2   | 1.5 | 2.5 | 0.25          | pF   | 4       |
| Data & DQS input/output capacitance                              | COUT   | 3.5 | 4.5 | 0.5           | pF   | 1,2,3,4 |
| Input capacitance(DM for x4/8, UDM/LDM for x16)                  | CIN3   | 3.5 | 4.5 |               | pF   | 1,2,3,4 |

Note :

- These values are guaranteed by design and are tested on a sample basis only.
- Although DM is an input -only pin, the input capacitance of this pin must model the input capacitance of the DQ and DQS pins.  
This is required to match signal propagation times of DQ, DQS, and DM in the system.
- Unused pins are tied to ground.
- This parameter is sampled. For DDR266 and DDR333 VDDQ = +2.5V +0.2V, VDD = +3.3V +0.3V or +0.25V+0.2V. For  
DDR400, VDDQ = +2.6V +0.1V, VDD = +2.6V +0.1V. For all devices, f=100MHz, TA=25°C, Vout(dc) = VDDQ/2, Vout(peak to  
peak) = 0.2V. DM inputs are grouped with I/O pins - reflecting the fact that they are matched in loading (to facilitate trace  
matching at the board level).

**14.0 Detailed test condition for DDR SDRAM IDD1 & IDD7A****IDD1 : Operating current: One bank operation**

1. Typical Case: Fro DDR200,266,333: Vdd = 2.5V, T=25°C; For DDR400: Vdd=2.6V,T=25°C  
Worst Case : Vdd = 2.7V, T= 10°C
2. Only one bank is accessed with tRC(min), Burst Mode, Address and Control inputs on NOP edge are changing once per clock cycle. Iout = 0mA
3. Timing patterns
  - B0(133Mhz, CL=2.5) : tCK = 7.5ns, CL=2.5, BL=4, tRCD = 3\*tCK, tRC = 9\*tCK, tRAS = 6\*tCK  
Read : A0 N N R0 N N P0 N N A0 N - repeat the same timing with random address changing  
\*50% of data changing at every burst
  - A2 (133Mhz, CL=2) : tCK = 7.5ns, CL=2, BL=4, tRCD = 3\*tCK, tRC = 9\*tCK, tRAS = 6\*tCK  
Read : A0 N N R0 N N P0 N N A0 N - repeat the same timing with random address changing  
\*50% of data changing at every burst
  - B3(166Mhz, CL=2.5) : tCK=6ns, CL=2.5, BL=4, tRCD=3\*tCK, tRC = 10\*tCK, tRAS=7\*tCK  
Read : A0 N N R0 N N P0 N N A0 N - repeat the same timing with random address changing  
\*50% of data changing at every burst
  - CC(200Mhz,CL = 3) : tCK = 5ns, CL = 3, BL = 4, tRCD = 3\*tCK , tRC = 11\*tCK, tRAS = 8\*tCK  
Read : A0 N N R0 N N N N P0 N N - repeat the same timing with random address changing  
\*50% of data changing at every transfer

Legend : A=Activate, R=Read, W=Write, P=Precharge, N=DESELECT

**IDD7A : Operating current: Four bank operation**

1. Typical Case: Fro DDR200,266,333: Vdd = 2.5V, T=25°C; For DDR400: Vdd=2.6V,T=25°C  
Worst Case : Vdd = 2.7V, T= 10°C
2. Four banks are being interleaved with tRC(min), Burst Mode, Address and Control inputs on NOP edge are not changing. Iout = 0mA
4. Timing patterns
  - B0(133Mhz, CL=2.5) : tCK = 7.5ns, CL=2.5, BL=4, tRRD = 2\*tCK, tRCD = 3\*tCK, Read with autoprecharge  
Read : A0 N A1 R0 A2 R1 A3 R2 N R3 A0 N A1 R0 - repeat the same timing with random address changing  
\*50% of data changing at every burst
  - A2(133Mhz, CL=2) : tCK = 7.5ns, CL=2, BL=4, tRRD = 2\*tCK, tRCD = 3\*tCK, Read with autoprecharge  
Read : A0 N A1 R0 A2 R1 A3 R2 N R3 A0 N A1 R0 - repeat the same timing with random address changing  
\*50% of data changing at every burst
  - B3(166Mhz,CL=2.5) : tCK=6ns, CL=2.5, BL=4, tRRD=2\*tCK, tRCD=3\*tCK, Read with autoprecharge  
Read : A0 N A1 R0 A2 R1 A3 R2 N R3 A0 N A1 R0 - repeat the same timing with random address changing  
\*50% of data changing at every burst
  - CC(200Mhz,CL = 3) : tCK = 5ns, CL = 3, BL = 4, tRCD = 3\*tCK , tRC = 11\*tCK, tRAS = 8\*tCK  
Read : A0 N N R0 N N N N P0 N N - repeat the same timing with random address changing  
\*50% of data changing at every transfer

Legend : A=Activate, R=Read, W=Write, P=Precharge, N=DESELECT

15.0 DDR SDRAM IDD spec table

(V<sub>DD</sub>=2.7V, T = 10°C)

| Symbol | 64Mx4 (K4H510438B) |                   |                   |                   | Unit | Notes    |
|--------|--------------------|-------------------|-------------------|-------------------|------|----------|
|        | CC(DDR400@CL=3)    | B3(DDR333@CL=2.5) | A2(DDR266@CL=2.0) | B0(DDR266@CL=2.5) |      |          |
| IDD0   | 165                | 125               | 110               | 110               | mA   |          |
| IDD1   | 185                | 150               | 135               | 135               | mA   |          |
| IDD2P  | 5                  | 5                 | 5                 | 5                 | mA   |          |
| IDD2F  | 30                 | 30                | 30                | 30                | mA   |          |
| IDD2Q  | 25                 | 25                | 25                | 25                | mA   |          |
| IDD3P  | 55                 | 30                | 30                | 30                | mA   |          |
| IDD3N  | 95                 | 50                | 50                | 50                | mA   |          |
| IDD4R  | 200                | 180               | 150               | 150               | mA   |          |
| IDD4W  | 240                | 185               | 155               | 155               | mA   |          |
| IDD5   | 265                | 250               | 240               | 240               | mA   |          |
| IDD6   | Normal             | 5                 | 5                 | 5                 | mA   |          |
|        | Low power          | 3                 | 3                 | 3                 | mA   | Optional |
| IDD7A  | 430                | 390               | 340               | 340               | mA   |          |

| Symbol | 64Mx8 (K4H510838B) |                   |                   |                   | Unit | Notes    |
|--------|--------------------|-------------------|-------------------|-------------------|------|----------|
|        | CC(DDR400@CL=3)    | B3(DDR333@CL=2.5) | A2(DDR266@CL=2.0) | B0(DDR266@CL=2.5) |      |          |
| IDD0   | 165                | 125               | 110               | 110               | mA   |          |
| IDD1   | 185                | 150               | 135               | 135               | mA   |          |
| IDD2P  | 5                  | 5                 | 5                 | 5                 | mA   |          |
| IDD2F  | 30                 | 30                | 30                | 30                | mA   |          |
| IDD2Q  | 25                 | 25                | 25                | 25                | mA   |          |
| IDD3P  | 55                 | 30                | 30                | 30                | mA   |          |
| IDD3N  | 95                 | 50                | 50                | 50                | mA   |          |
| IDD4R  | 200                | 180               | 150               | 150               | mA   |          |
| IDD4W  | 240                | 185               | 155               | 155               | mA   |          |
| IDD5   | 265                | 250               | 240               | 240               | mA   |          |
| IDD6   | Normal             | 5                 | 5                 | 5                 | mA   |          |
|        | Low power          | 3                 | 3                 | 3                 | mA   | Optional |
| IDD7A  | 430                | 390               | 340               | 340               | mA   |          |

| Symbol | 32Mx16 (K4H511638B) |                   |                   |                   | Unit | Notes    |
|--------|---------------------|-------------------|-------------------|-------------------|------|----------|
|        | CC(DDR400@CL=3)     | B3(DDR333@CL=2.5) | A2(DDR266@CL=2.0) | B0(DDR266@CL=2.5) |      |          |
| IDD0   | 165                 | 125               | 110               | 110               | mA   |          |
| IDD1   | 190                 | 155               | 140               | 140               | mA   |          |
| IDD2P  | 5                   | 5                 | 5                 | 5                 | mA   |          |
| IDD2F  | 30                  | 30                | 30                | 30                | mA   |          |
| IDD2Q  | 25                  | 25                | 25                | 25                | mA   |          |
| IDD3P  | 55                  | 30                | 30                | 30                | mA   |          |
| IDD3N  | 100                 | 50                | 50                | 50                | mA   |          |
| IDD4R  | 230                 | 195               | 170               | 170               | mA   |          |
| IDD4W  | 280                 | 215               | 190               | 190               | mA   |          |
| IDD5   | 265                 | 250               | 240               | 240               | mA   |          |
| IDD6   | Normal              | 5                 | 5                 | 5                 | mA   |          |
|        | Low power           | 3                 | 3                 | 3                 | mA   | Optional |
| IDD7A  | 450                 | 405               | 360               | 360               | mA   |          |

16.0 AC Operating Conditions

| Parameter/Condition                                  | Symbol               | Min                       | Max                       | Unit | Note |
|--|----------------------|---------------------------|---------------------------|------|------|
| Input High (Logic 1) Voltage, DQ, DQS and DM signals | V <sub>IH</sub> (AC) | V <sub>REF</sub> + 0.31   |                           | V    |      |
| Input Low (Logic 0) Voltage, DQ, DQS and DM signals. | V <sub>IL</sub> (AC) |                           | V <sub>REF</sub> - 0.31   | V    |      |
| Input Differential Voltage, CK and /CK inputs        | V <sub>ID</sub> (AC) | 0.7                       | V <sub>DDQ</sub> +0.6     | V    | 1    |
| Input Crossing Point Voltage, CK and /CK inputs      | V <sub>IX</sub> (AC) | 0.5*V <sub>DDQ</sub> -0.2 | 0.5*V <sub>DDQ</sub> +0.2 | V    | 2    |

Note :

1. V<sub>ID</sub> is the magnitude of the difference between the input level on CK and the input level on /CK.
2. The value of V<sub>IX</sub> is expected to equal 0.5\*V<sub>DDQ</sub> of the transmitting device and must track variations in the dc level of the same.

17.0 AC Overshoot/Undershoot specification for Address and Control Pins

| Parameter  | Specification |        |            |
|--|---------------|--------|------------|
|  | DDR400        | DDR333 | DDR200/266 |
| Maximum peak amplitude allowed for overshoot                                 | TBD           | TBD    | 1.5 V      |
| Maximum peak amplitude allowed for undershoot                                | TBD           | TBD    | 1.5 V      |
| The area between the overshoot signal and VDD must be less than or equal to  | TBD           | TBD    | 4.5 V-ns   |
| The area between the undershoot signal and GND must be less than or equal to | TBD           | TBD    | 4.5 V-ns   |

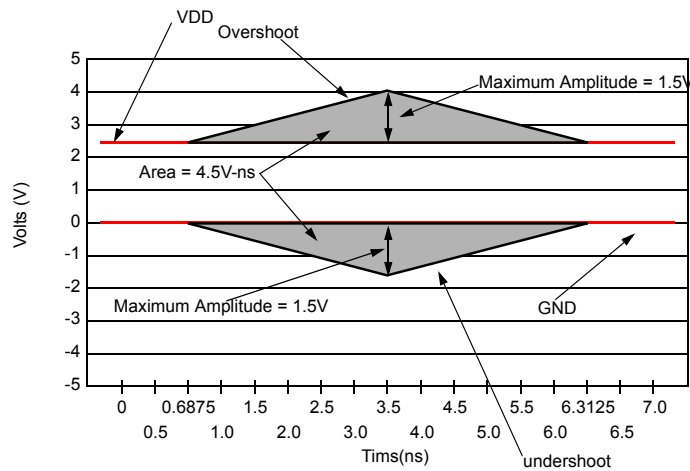

AC overshoot/Undershoot Definition

18.0 Overshoot/Undershoot specification for Data, Strobe and Mask Pins

| Parameter  | Specification |        |            |
|--|---------------|--------|------------|
|  | DDR400        | DDR333 | DDR200/266 |
| Maximum peak amplitude allowed for overshoot                                 | TBD           | TBD    | 1.2 V      |
| Maximum peak amplitude allowed for undershoot                                | TBD           | TBD    | 1.2 V      |
| The area between the overshoot signal and VDD must be less than or equal to  | TBD           | TBD    | 2.4 V-ns   |
| The area between the undershoot signal and GND must be less than or equal to | TBD           | TBD    | 2.4 V-ns   |

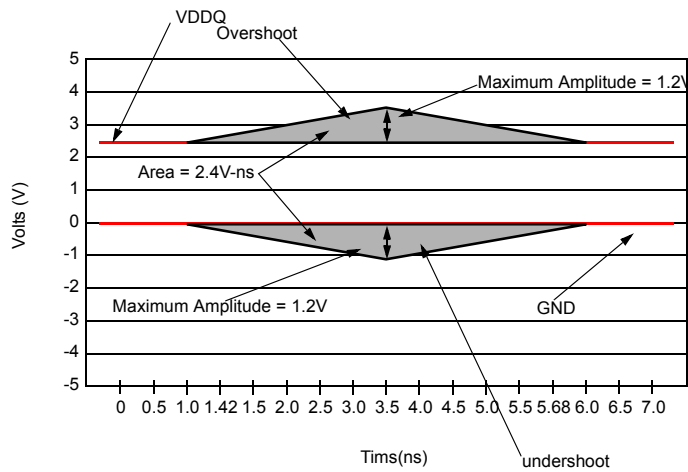

DQ/DM/DQS AC overshoot/Undershoot Definition

19.0 AC Timing Parameters & Specifications

| Parameter                                     | Symbol | CC<br>(DDR400@CL=3.0)       |       | B3<br>(DDR333@CL=2.5)       |      | A2<br>(DDR266@CL=2.0)       |       | B0<br>(DDR266@CL=2.5)       |       | Unit | Note      |  |
|---|--------|-----------------------------|-------|-----------------------------|------|-----------------------------|-------|-----------------------------|-------|------|-----------|--|
|   |        | Min                         | Max   | Min                         | Max  | Min                         | Max   | Min                         | Max   |      |           |  |
| Row cycle time                                | tRC    | 55                          |       | 60                          |      | 65                          |       | 65                          |       | ns   |           |  |
| Refresh row cycle time                        | tRFC   | 70                          |       | 72                          |      | 75                          |       | 75                          |       | ns   |           |  |
| Row active time                               | tRAS   | 40                          | 70K   | 42                          | 70K  | 45                          | 70K   | 45                          | 70K   | ns   |           |  |
| RAS to CAS delay                              | tRCD   | 15                          |       | 18                          |      | 20                          |       | 20                          |       | ns   |           |  |
| Row precharge time                            | tRP    | 15                          |       | 18                          |      | 20                          |       | 20                          |       | ns   |           |  |
| Row active to Row active delay                | tRRD   | 10                          |       | 12                          |      | 15                          |       | 15                          |       | ns   |           |  |
| Write recovery time                           | tWR    | 15                          |       | 15                          |      | 15                          |       | 15                          |       | ns   |           |  |
| Last data in to Read command                  | tWTR   | 2                           |       | 1                           |      | 1                           |       | 1                           |       | tCK  |           |  |
| Clock cycle time                              | tCK    | CL=2.0                      | -     | -                           | 7.5  | 12                          | 7.5   | 12                          | 10    | 12   | ns        |  |
|   |        | CL=2.5                      | 6     | 12                          | 6    | 12                          | 7.5   | 12                          | 7.5   | 12   | ns        |  |
|   |        | CL=3.0                      | 5     | 10                          | -    | -                           | -     | -                           | -     | -    | -         |  |
| Clock high level width                        | tCH    | 0.45                        | 0.55  | 0.45                        | 0.55 | 0.45                        | 0.55  | 0.45                        | 0.55  | tCK  |           |  |
| Clock low level width                         | tCL    | 0.45                        | 0.55  | 0.45                        | 0.55 | 0.45                        | 0.55  | 0.45                        | 0.55  | tCK  |           |  |
| DQS-out access time from CK/CK                | tDQSCK | -0.55                       | +0.55 | -0.6                        | +0.6 | -0.75                       | +0.75 | -0.75                       | +0.75 | ns   |           |  |
| Output data access time from CK/CK            | tAC    | -0.65                       | +0.65 | -0.7                        | +0.7 | -0.75                       | +0.75 | -0.75                       | +0.75 | ns   |           |  |
| Data strobe edge to output data edge          | tDQSQ  | -                           | 0.4   | -                           | 0.45 | -                           | 0.5   | -                           | 0.5   | ns   | 22        |  |
| Read Preamble                                 | tRPRE  | 0.9                         | 1.1   | 0.9                         | 1.1  | 0.9                         | 1.1   | 0.9                         | 1.1   | tCK  |           |  |
| Read Postamble                                | tRPST  | 0.4                         | 0.6   | 0.4                         | 0.6  | 0.4                         | 0.6   | 0.4                         | 0.6   | tCK  |           |  |
| CK to valid DQS-in                            | tDQSS  | 0.72                        | 1.28  | 0.75                        | 1.25 | 0.75                        | 1.25  | 0.75                        | 1.25  | tCK  |           |  |
| DQS-in setup time                             | tWPRES | 0                           |       | 0                           |      | 0                           |       | 0                           |       | ns   | 13        |  |
| DQS-in hold time                              | tWPRE  | 0.25                        |       | 0.25                        |      | 0.25                        |       | 0.25                        |       | tCK  |           |  |
| DQS falling edge to CK rising-setup time      | tDSS   | 0.2                         |       | 0.2                         |      | 0.2                         |       | 0.2                         |       | tCK  |           |  |
| DQS falling edge from CK rising-hold time     | tDSH   | 0.2                         |       | 0.2                         |      | 0.2                         |       | 0.2                         |       | tCK  |           |  |
| DQS-in high level width                       | tDQSH  | 0.35                        |       | 0.35                        |      | 0.35                        |       | 0.35                        |       | tCK  |           |  |
| DQS-in low level width                        | tDQSL  | 0.35                        |       | 0.35                        |      | 0.35                        |       | 0.35                        |       | tCK  |           |  |
| Address and Control Input setup time(fast)    | tIS    | 0.6                         |       | 0.75                        |      | 0.9                         |       | 0.9                         |       | ns   | 15, 17~19 |  |
| Address and Control Input hold time(fast)     | tIH    | 0.6                         |       | 0.75                        |      | 0.9                         |       | 0.9                         |       | ns   | 15, 17~19 |  |
| Address and Control Input setup               | tIS    | 0.7                         |       | 0.8                         |      | 1.0                         |       | 1.0                         |       | ns   | 16~19     |  |
| Address and Control Input hold time(slow)     | tIH    | 0.7                         |       | 0.8                         |      | 1.0                         |       | 1.0                         |       | ns   | 16~19     |  |
| Data-out high impedance time from CK/CK       | tHZ    | -0.65                       | +0.65 | -0.7                        | +0.7 | -0.75                       | +0.75 | -0.75                       | +0.75 | ns   | 11        |  |
| Data-out low impedance time from CK/CK        | tLZ    | -0.65                       | +0.65 | -0.7                        | +0.7 | -0.75                       | +0.75 | -0.75                       | +0.75 | ns   | 11        |  |
| Mode register set cycle time                  | tMRD   | 10                          |       | 12                          |      | 15                          |       | 15                          |       | ns   |           |  |
| DQ & DM setup time to DQS                     | tDS    | 0.4                         |       | 0.45                        |      | 0.5                         |       | 0.5                         |       | ns   | j, k      |  |
| DQ & DM hold time to DQS                      | tDH    | 0.4                         |       | 0.45                        |      | 0.5                         |       | 0.5                         |       | ns   | j, k      |  |
| Control & Address input pulse width           | tIPW   | 2.2                         |       | 2.2                         |      | 2.2                         |       | 2.2                         |       | ns   | 18        |  |
| DQ & DM input pulse width                     | tDIPW  | 1.75                        |       | 1.75                        |      | 1.75                        |       | 1.75                        |       | ns   | 18        |  |
| Exit self refresh to non-Read command         | tXSNR  | 75                          |       | 75                          |      | 75                          |       | 75                          |       | ns   |           |  |
| Exit self refresh to read command             | tXSRD  | 200                         |       | 200                         |      | 200                         |       | 200                         |       | tCK  |           |  |
| Refresh interval time                         | tREFI  |                             | 7.8   |                             | 7.8  |                             | 7.8   |                             | 7.8   | us   | 14        |  |
| Output DQS valid window                       | tQH    | tHP<br>-tQHS                | -     | tHP<br>-tQHS                | -    | tHP<br>-tQHS                | -     | tHP<br>-tQHS                | -     | ns   | 21        |  |
| Clock half period                             | tHP    | tCLmin<br>or tCHmin         | -     | tCLmin<br>or tCHmin         | -    | tCLmin<br>or tCHmin         | -     | tCLmin<br>or tCHmin         | -     | ns   | 20, 21    |  |
| Data hold skew factor                         | tQHS   |                             | 0.5   |                             | 0.55 |                             | 0.75  |                             | 0.75  | ns   | 21        |  |
| DQS write postamble time                      | tWPST  | 0.4                         | 0.6   | 0.4                         | 0.6  | 0.4                         | 0.6   | 0.4                         | 0.6   | tCK  | 12        |  |
| Active to Read with Auto precharge command    | tRAP   | 15                          |       | 18                          |      | 20                          |       | 20                          |       |      |           |  |
| Autoprecharge write recovery + Precharge time | tDAL   | (tWR/tCK)<br>+<br>(tRP/tCK) |       | (tWR/tCK)<br>+<br>(tRP/tCK) |      | (tWR/tCK)<br>+<br>(tRP/tCK) |       | (tWR/tCK)<br>+<br>(tRP/tCK) |       | tCK  | 23        |  |



## 20.0 System Characteristics for DDR SDRAM

The following specification parameters are required in systems using DDR333, DDR266 & DDR200 devices to ensure proper system performance. these characteristics are for system simulation purposes and are guaranteed by design.

**Table 1 : Input Slew Rate for DQ, DQS, and DM**

| AC CHARACTERISTICS   |        | DDR333 |     | DDR266 |     | DDR200 |     |       |       |
|--|--------|--------|-----|--------|-----|--------|-----|-------|-------|
| PARAMETER  | SYMBOL | MIN    | MAX | MIN    | MAX | MIN    | MAX | Units | Notes |
| DQ/DM/DQS input slew rate measured between VIH(DC), VIL(DC) and VIL(DC), VIH(DC) | DCSLEW | TBD    | TBD | TBD    | TBD | 0.5    | 4.0 | V/ns  | a, m  |

**Table 2 : Input Setup & Hold Time Derating for Slew Rate**

| Input Slew Rate | $\Delta t_{IS}$ | $\Delta t_{IH}$ | Units | Notes |
|-----------------|-----------------|-----------------|-------|-------|
| 0.5 V/ns        | 0               | 0               | ps    | i     |
| 0.4 V/ns        | +50             | 0               | ps    | i     |
| 0.3 V/ns        | +100            | 0               | ps    | i     |

**Table 3 : Input/Output Setup & Hold Time Derating for Slew Rate**

| Input Slew Rate | $\Delta t_{DS}$ | $\Delta t_{DH}$ | Units | Notes |
|-----------------|-----------------|-----------------|-------|-------|
| 0.5 V/ns        | 0               | 0               | ps    | k     |
| 0.4 V/ns        | +75             | +75             | ps    | k     |
| 0.3 V/ns        | +150            | +150            | ps    | k     |

**Table 4 : Input/Output Setup & Hold Derating for Rise/Fall Delta Slew Rate**

| Delta Slew Rate | $\Delta t_{DS}$ | $\Delta t_{DH}$ | Units | Notes |
|-----------------|-----------------|-----------------|-------|-------|
| +/- 0.0 V/ns    | 0               | 0               | ps    | j     |
| +/- 0.25 V/ns   | +50             | +50             | ps    | j     |
| +/- 0.5 V/ns    | +100            | +100            | ps    | j     |

**Table 5 : Output Slew Rate Characteristic (X4, X8 Devices only)**

| Slew Rate Characteristic | Typical Range (V/ns) | Minimum (V/ns) | Maximum (V/ns) | Notes       |
|--------------------------|----------------------|----------------|----------------|-------------|
| Pullup Slew Rate         | 1.2 ~ 2.5            | 1.0            | 4.5            | a,c,d,f,g,h |
| Pulldown slew            | 1.2 ~ 2.5            | 1.0            | 4.5            | b,c,d,f,g,h |

**Table 6 : Output Slew Rate Characteristic (X16 Devices only)**

| Slew Rate Characteristic | Typical Range (V/ns) | Minimum (V/ns) | Maximum (V/ns) | Notes       |
|--------------------------|----------------------|----------------|----------------|-------------|
| Pullup Slew Rate         | 1.2 ~ 2.5            | 0.7            | 5.0            | a,c,d,f,g,h |
| Pulldown slew            | 1.2 ~ 2.5            | 0.7            | 5.0            | b,c,d,f,g,h |

**Table 7 : Output Slew Rate Matching Ratio Characteristics**

| AC CHARACTERISTICS                                   |  | DDR266B |     | DDR200 |     |       |
|--|--|---------|-----|--------|-----|-------|
| PARAMETER  |  | MIN     | MAX | MIN    | MAX | Notes |
| Output Slew Rate Matching Ratio (Pullup to Pulldown) |  | TBD     | TBD | 0.67   | 1.5 | e,m   |

## 21.0 Component Notes

1. All voltages referenced to Vss.
2. Tests for ac timing, IDD, and electrical, ac and dc characteristics, may be conducted at nominal reference/supply voltage levels, but the related specifications and device operation are guaranteed for the full voltage range specified.
3. Figure 1 represents the timing reference load used in defining the relevant timing parameters of the part. It is not intended to be either a precise representation of the typical system environment nor a depiction of the actual load presented by a production tester. System designers will use IBIS or other simulation tools to correlate the timing reference load to a system environment. Manufacturers will correlate to their production test conditions (generally a coaxial transmission line terminated at the tester electronics).

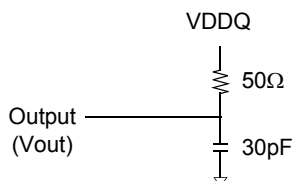

Figure 1 : Timing Reference Load

4. AC timing and IDD tests may use a VIL to VIH swing of up to 1.5 V in the test environment, but input timing is still referenced to VREF (or to the crossing point for CK/CK), and parameter specifications are guaranteed for the specified ac input levels under normal use conditions. The minimum slew rate for the input signals is 1 V/ns in the range between VIL(ac) and VIH(ac).
5. The ac and dc input level specifications are as defined in the SSTL\_2 Standard (i.e., the receiver will effectively switch as a result of the signal crossing the ac input level and will remain in that state as long as the signal does not ring back above (below) the dc input LOW (HIGH) level.
6. Inputs are not recognized as valid until VREF stabilizes. Exception: during the period before VREF stabilizes,  $CKE \leq 0.2VDDQ$  is recognized as LOW.
7. Enables on.chip refresh and address counters.
8. IDD specifications are tested after the device is properly initialized.
9. The  $CK/\overline{CK}$  input reference level (for timing referenced to  $CK/\overline{CK}$ ) is the point at which CK and  $\overline{CK}$  cross; the input reference level for signals other than  $CK/\overline{CK}$ , is VREF.
10. The output timing reference voltage level is VTT.
11. tHZ and tLZ transitions occur in the same access time windows as valid data transitions. These parameters are not referenced to a specific voltage level but specify when the device output is no longer driving (HZ), or begins driving (LZ).
12. The maximum limit for this parameter is not a device limit. The device will operate with a greater value for this parameter, but system performance (bus turnaround) will degrade accordingly.
13. The specific requirement is that DQS be valid (HIGH, LOW, or at some point on a valid transition) on or before this CK edge. A valid transition is defined as monotonic and meeting the input slew rate specifications of the device. when no writes were previously in progress on the bus, DQS will be transitioning from High-Z to logic LOW. If a previous write was in progress, DQS could be HIGH, LOW, or transitioning from HIGH to LOW at this time, depending on tDQSS.
14. A maximum of eight AUTO REFRESH commands can be posted to any given DDR SDRAM device.
15. For command/address input slew rate  $\geq 1.0$  V/ns
16. For command/address input slew rate  $\geq 0.5$  V/ns and  $< 1.0$  V/ns

**Component Notes**

17. For CK &  $\overline{\text{CK}}$  slew rate  $\geq 1.0$  V/ns
18. These parameters guarantee device timing, but they are not necessarily tested on each device. They may be guaranteed by device design or tester correlation.
19. Slew Rate is measured between VOH(ac) and VOL(ac).
20. Min (tCL, tCH) refers to the smaller of the actual clock low time and the actual clock high time as provided to the device (i.e. this value can be greater than the minimum specification limits for tCL and tCH).....For example, tCL and tCH are = 50% of the period, less the half period jitter (tJIT(HP)) of the clock source, and less the half period jitter due to crosstalk (tJIT(crosstalk)) into the clock traces.
21. tQH = tHP - tQHS, where:  
tHP = minimum half clock period for any given cycle and is defined by clock high or clock low (tCH, tCL). tQHS accounts for 1) The pulse duration distortion of on-chip clock circuits; and 2) The worst case push-out of DQS on one transition followed by the worst case pull-in of DQ on the next transition, both of which are, separately, due to data pin skew and output pattern effects, and p-channel to n-channel variation of the output drivers.
22. tDQSQ  
Consists of data pin skew and output pattern effects, and p-channel to n-channel variation of the output drivers for any given cycle.
23. tDAL = (tWR/tCK) + (tRP/tCK)  
For each of the terms above, if not already an integer, round to the next highest integer. Example: For DDR266B at CL=2.5 and tCK=7.5ns tDAL = (15 ns / 7.5 ns) + (20 ns / 7.5ns) = (2) + (3)  
tDAL = 5 clocks

22.0 System Notes

a. Pullup slew rate is characterized under the test conditions as shown in Figure 2.

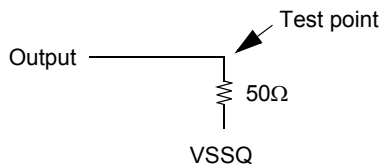

Figure 2 : Pullup slew rate test load

b. Pulldown slew rate is measured under the test conditions shown in Figure 3.

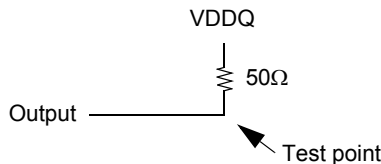

Figure 3 : Pulldown slew rate test load

- c. Pullup slew rate is measured between (VDDQ/2 - 320 mV +/- 250 mV)  
 Pulldown slew rate is measured between (VDDQ/2 + 320 mV +/- 250 mV)  
 Pullup and Pulldown slew rate conditions are to be met for any pattern of data, including all outputs switching and only one output switching.

Example : For typical slew rate, DQ0 is switching  
 For minimum slew rate, all DQ bits are switching from either high to low, or low to high.  
 The remaining DQ bits remain the same as for previous state.

d. Evaluation conditions

Typical : 25 °C (T Ambient), VDDQ = 2.5V(for DDR266/333) and 2.6V(for DDR400), typical process  
 Minimum : 70 °C (T Ambient), VDDQ = 2.3V(for DDR266/333) and 2.5V(for DDR400), slow - slow process  
 Maximum : 0 °C (T Ambient), VDDQ = 2.7V(for DDR266/333) and 2.7V(for DDR400), fast - fast process

e. The ratio of pullup slew rate to pulldown slew rate is specified for the same temperature and voltage, over the entire temperature and voltage range. For a given output, it represents the maximum difference between pullup and pulldown drivers due to process variation.

f. Verified under typical conditions for qualification purposes.

g. TSOPII package devices only.

h. Only intended for operation up to 266 Mbps per pin.

i. A derating factor will be used to increase tIS and tIH in the case where the input slew rate is below 0.5V/ns as shown in Table 2. The Input slew rate is based on the lesser of the slew rates determined by either VIH(AC) to VIL(AC) or VIH(DC) to VIL(DC), similarly for rising transitions.

j. A derating factor will be used to increase tDS and tDH in the case where DQ, DM, and DQS slew rates differ, as shown in Tables 3 & 4. Input slew rate is based on the larger of AC-AC delta rise, fall rate and DC-DC delta rise, Input slew rate is based on the lesser of the slew rates determined by either VIH(AC) to VIL(AC) or VIH(DC) to VIL(DC), similarly for rising transitions.

The delta rise/fall rate is calculated as:  
 $\{1/(\text{Slew Rate1})\} - \{1/(\text{Slew Rate2})\}$

For example : If Slew Rate 1 is 0.5 V/ns and slew Rate 2 is 0.4 V/ns, then the delta rise, fall rate is - 0.5ns/V . Using the table given, this would result in the need for an increase in tDS and tDH of 100 ps.

k. Table 3 is used to increase tDS and tDH in the case where the I/O slew rate is below 0.5 V/ns. The I/O slew rate is based on the lesser on the lesser of the AC - AC slew rate and the DC- DC slew rate. The input slew rate is based on the lesser of the slew rates determined by either VIH(ac) to VIL(ac) or VIH(DC) to VIL(DC), and similarly for rising transitions.

m. DQS, DM, and DQ input slew rate is specified to prevent double clocking of data and preserve setup and hold times. Signal transitions through the DC region must be monotonic.

### 23.0 IBIS : I/V Characteristics for Input and Output Buffers

#### DDR SDRAM Output Driver V-I Characteristics

DDR SDRAM Output driver characteristics are defined for full and half strength operation as selected by the EMRS bit A1.

Figures 3 and 4 show the driver characteristics graphically, and tables 8 and 9 show the same data in tabular format suitable for input into simulation tools. The driver characteristics evaluation conditions are:

|         |      |   |
|---------|------|---|
| Typical | 25°C | V <sub>dd</sub> /V <sub>ddq</sub> = 2.5V, typical process   |
| Minimum | 70°C | V <sub>dd</sub> /V <sub>ddq</sub> = 2.3V, slow-slow process |
| Maximum | 0°C  | V <sub>dd</sub> /V <sub>ddq</sub> = 2.7V, fast-fast process |

#### Output Driver Characteristic Curves Notes:

1. The full variation in driver current from minimum to maximum process, temperature and voltage will lie within the outer bounding lines of the V-I curve of Figure 3 and 4.
2. It is recommended that the "typical" IBIS V-I curve lie within the inner bounding lines of the V-I curves of Figure 3 and 4.
3. The full variation in the ratio of the "typical" IBIS pullup to "typical" IBIS pulldown current should be unity +/- 10%, for device drain to source voltages from 0.1 to 1.0. This specification is a design objective only. It is not guaranteed.

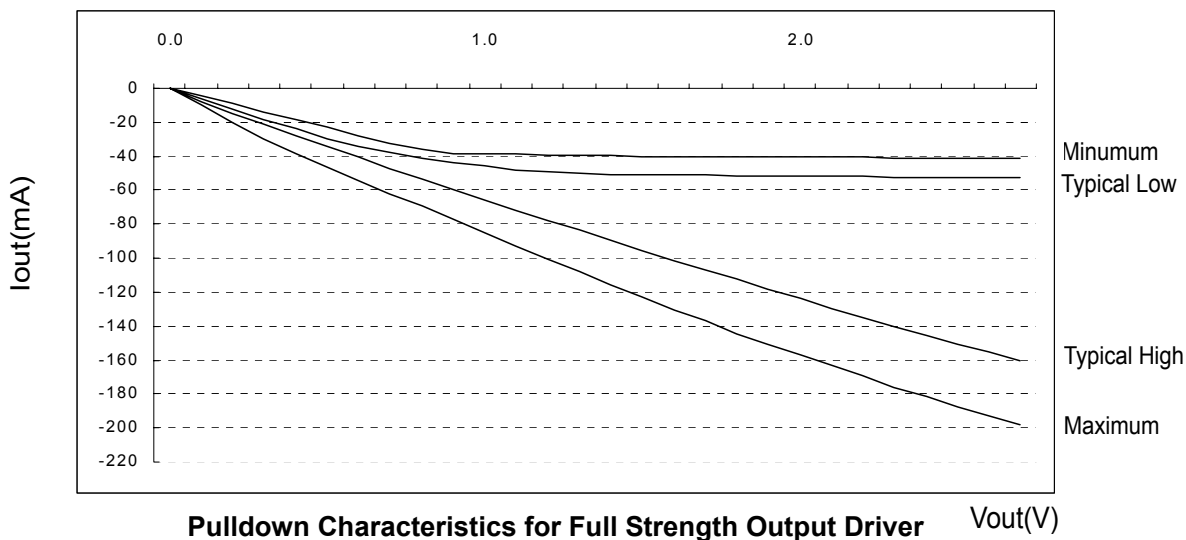
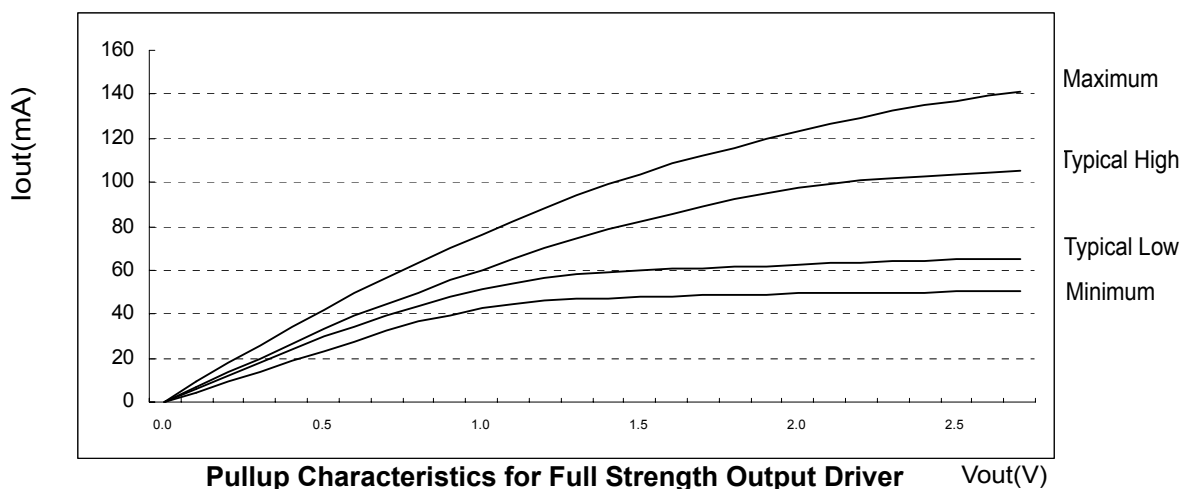

Figure 3. I/V characteristics for input/output buffers: Pull up (above) and pull down (below)

| Voltage (V) | Pulldown Current (mA) |              |         |         | pullup Current (mA) |              |         |         |
|-------------|-----------------------|--------------|---------|---------|---------------------|--------------|---------|---------|
|             | Typical Low           | Typical High | Minimum | Maximum | Typical Low         | Typical High | Minimum | Maximum |
| 0.1         | 6.0                   | 6.8          | 4.6     | 9.6     | -6.1                | -7.6         | -4.6    | -10.0   |
| 0.2         | 12.2                  | 13.5         | 9.2     | 18.2    | -12.2               | -14.5        | -9.2    | -20.0   |
| 0.3         | 18.1                  | 20.1         | 13.8    | 26.0    | -18.1               | -21.2        | -13.8   | -29.8   |
| 0.4         | 24.1                  | 26.6         | 18.4    | 33.9    | -24.0               | -27.7        | -18.4   | -38.8   |
| 0.5         | 29.8                  | 33.0         | 23.0    | 41.8    | -29.8               | -34.1        | -23.0   | -46.8   |
| 0.6         | 34.6                  | 39.1         | 27.7    | 49.4    | -34.3               | -40.5        | -27.7   | -54.4   |
| 0.7         | 39.4                  | 44.2         | 32.2    | 56.8    | -38.1               | -46.9        | -32.2   | -61.8   |
| 0.8         | 43.7                  | 49.8         | 36.8    | 63.2    | -41.1               | -53.1        | -36.0   | -69.5   |
| 0.9         | 47.5                  | 55.2         | 39.6    | 69.9    | -41.8               | -59.4        | -38.2   | -77.3   |
| 1.0         | 51.3                  | 60.3         | 42.6    | 76.3    | -46.0               | -65.5        | -38.7   | -85.2   |
| 1.1         | 54.1                  | 65.2         | 44.8    | 82.5    | -47.8               | -71.6        | -39.0   | -93.0   |
| 1.2         | 56.2                  | 69.9         | 46.2    | 88.3    | -49.2               | -77.6        | -39.2   | -100.6  |
| 1.3         | 57.9                  | 74.2         | 47.1    | 93.8    | -50.0               | -83.6        | -39.4   | -108.1  |
| 1.4         | 59.3                  | 78.4         | 47.4    | 99.1    | -50.5               | -89.7        | -39.6   | -115.5  |
| 1.5         | 60.1                  | 82.3         | 47.7    | 103.8   | -50.7               | -95.5        | -39.9   | -123.0  |
| 1.6         | 60.5                  | 85.9         | 48.0    | 108.4   | -51.0               | -101.3       | -40.1   | -130.4  |
| 1.7         | 61.0                  | 89.1         | 48.4    | 112.1   | -51.1               | -107.1       | -40.2   | -136.7  |
| 1.8         | 61.5                  | 92.2         | 48.9    | 115.9   | -51.3               | -112.4       | -40.3   | -144.2  |
| 1.9         | 62.0                  | 95.3         | 49.1    | 119.6   | -51.5               | -118.7       | -40.4   | -150.5  |
| 2.0         | 62.5                  | 97.2         | 49.4    | 123.3   | -51.6               | -124.0       | -40.5   | -156.9  |
| 2.1         | 62.9                  | 99.1         | 49.6    | 126.5   | -51.8               | -129.3       | -40.6   | -163.2  |
| 2.2         | 63.3                  | 100.9        | 49.8    | 129.5   | -52.0               | -134.6       | -40.7   | -169.6  |
| 2.3         | 63.8                  | 101.9        | 49.9    | 132.4   | -52.2               | -139.9       | -40.8   | -176.0  |
| 2.4         | 64.1                  | 102.8        | 50.0    | 135.0   | -52.3               | -145.2       | -40.9   | -181.3  |
| 2.5         | 64.6                  | 103.8        | 50.2    | 137.3   | -52.5               | -150.5       | -41.0   | -187.6  |
| 2.6         | 64.8                  | 104.6        | 50.4    | 139.2   | -52.7               | -155.3       | -41.1   | -192.9  |
| 2.7         | 65.0                  | 105.4        | 50.5    | 140.8   | -52.8               | -160.1       | -41.2   | -198.2  |

Table 8. Full Strength Driver Characteristics

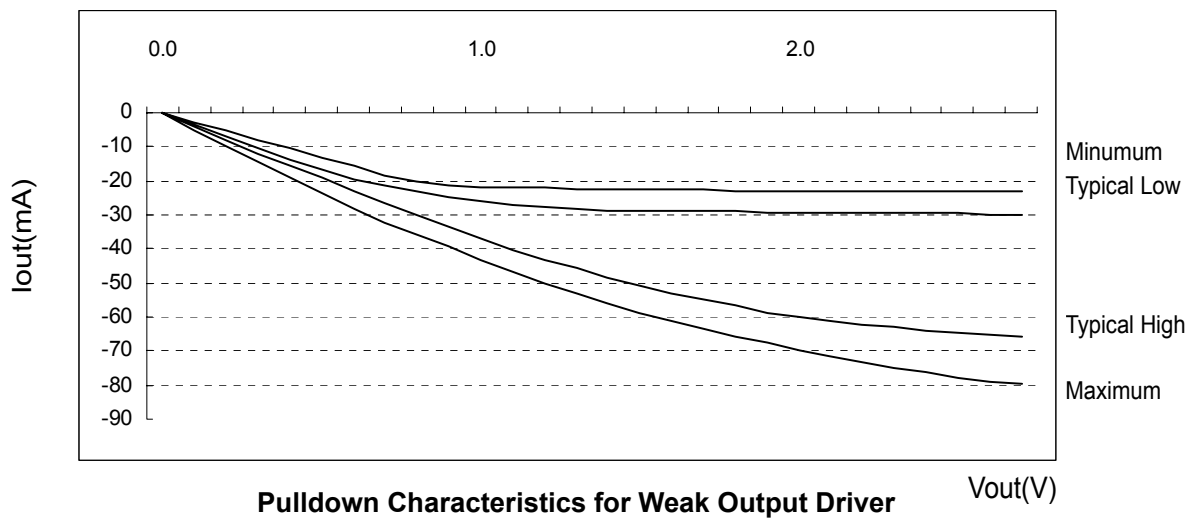
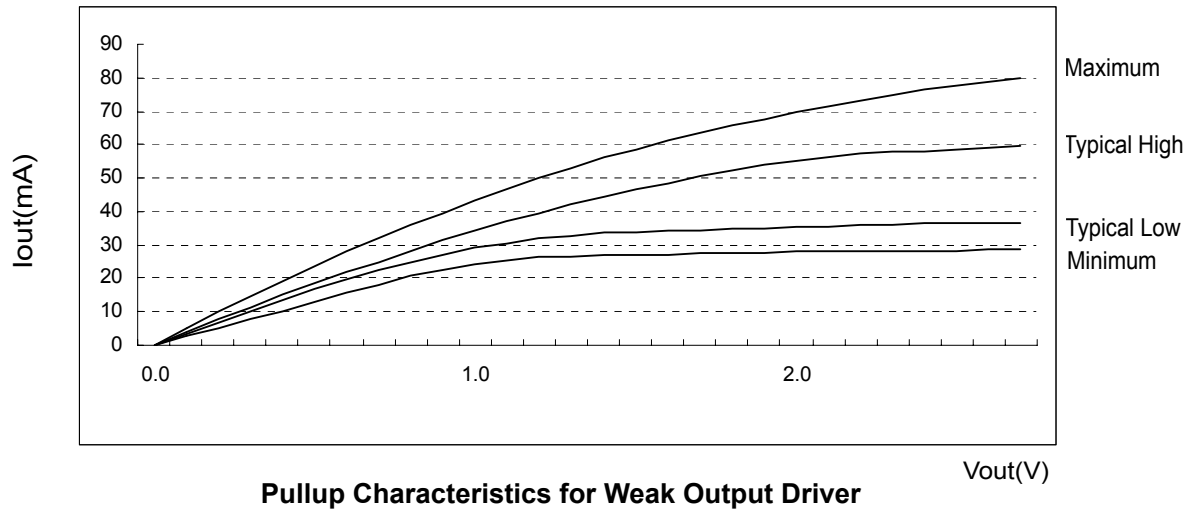

Figure 4. I/V characteristics for input/output buffers: Pull up(above) and pull down(below)

| Voltage (V) | Pulldown Current (mA) |              |         |         | pullup Current (mA) |              |         |         |
|-------------|-----------------------|--------------|---------|---------|---------------------|--------------|---------|---------|
|             | Typical Low           | Typical High | Minimum | Maximum | Typical Low         | Typical High | Minimum | Maximum |
| 0.1         | 3.4                   | 3.8          | 2.6     | 5.0     | -3.5                | -4.3         | -2.6    | -5.0    |
| 0.2         | 6.9                   | 7.6          | 5.2     | 9.9     | -6.9                | -8.2         | -5.2    | -9.9    |
| 0.3         | 10.3                  | 11.4         | 7.8     | 14.6    | -10.3               | -12.0        | -7.8    | -14.6   |
| 0.4         | 13.6                  | 15.1         | 10.4    | 19.2    | -13.6               | -15.7        | -10.4   | -19.2   |
| 0.5         | 16.9                  | 18.7         | 13.0    | 23.6    | -16.9               | -19.3        | -13.0   | -23.6   |
| 0.6         | 19.6                  | 22.1         | 15.7    | 28.0    | -19.4               | -22.9        | -15.7   | -28.0   |
| 0.7         | 22.3                  | 25.0         | 18.2    | 32.2    | -21.5               | -26.5        | -18.2   | -32.2   |
| 0.8         | 24.7                  | 28.2         | 20.8    | 35.8    | -23.3               | -30.1        | -20.4   | -35.8   |
| 0.9         | 26.9                  | 31.3         | 22.4    | 39.5    | -24.8               | -33.6        | -21.6   | -39.5   |
| 1.0         | 29.0                  | 34.1         | 24.1    | 43.2    | -26.0               | -37.1        | -21.9   | -43.2   |
| 1.1         | 30.6                  | 36.9         | 25.4    | 46.7    | -27.1               | -40.3        | -22.1   | -46.7   |
| 1.2         | 31.8                  | 39.5         | 26.2    | 50.0    | -27.8               | -43.1        | -22.2   | -50.0   |
| 1.3         | 32.8                  | 42.0         | 26.6    | 53.1    | -28.3               | -45.8        | -22.3   | -53.1   |
| 1.4         | 33.5                  | 44.4         | 26.8    | 56.1    | -28.6               | -48.4        | -22.4   | -56.1   |
| 1.5         | 34.0                  | 46.6         | 27.0    | 58.7    | -28.7               | -50.7        | -22.6   | -58.7   |
| 1.6         | 34.3                  | 48.6         | 27.2    | 61.4    | -28.9               | -52.9        | -22.7   | -61.4   |
| 1.7         | 34.5                  | 50.5         | 27.4    | 63.5    | -28.9               | -55.0        | -22.7   | -63.5   |
| 1.8         | 34.8                  | 52.2         | 27.7    | 65.6    | -29.0               | -56.8        | -22.8   | -65.6   |
| 1.9         | 35.1                  | 53.9         | 27.8    | 67.7    | -29.2               | -58.7        | -22.9   | -67.7   |
| 2.0         | 35.4                  | 55.0         | 28.0    | 69.8    | -29.2               | -60.0        | -22.9   | -69.8   |
| 2.1         | 35.6                  | 56.1         | 28.1    | 71.6    | -29.3               | -61.2        | -23.0   | -71.6   |
| 2.2         | 35.8                  | 57.1         | 28.2    | 73.3    | -29.5               | -62.4        | -23.0   | -73.3   |
| 2.3         | 36.1                  | 57.7         | 28.3    | 74.9    | -29.5               | -63.1        | -23.1   | -74.9   |
| 2.4         | 36.3                  | 58.2         | 28.3    | 76.4    | -29.6               | -63.8        | -23.2   | -76.4   |
| 2.5         | 36.5                  | 58.7         | 28.4    | 77.7    | -29.7               | -64.4        | -23.2   | -77.7   |
| 2.6         | 36.7                  | 59.2         | 28.5    | 78.8    | -29.8               | -65.1        | -23.3   | -78.8   |
| 2.7         | 36.8                  | 59.6         | 28.6    | 79.7    | -29.9               | -65.8        | -23.3   | -79.7   |

Table 9. Weak Driver Characteristics