

**High Power Linear Amplifier
2.3 – 2.8 GHz**

**MAAPSS0103
V3**

Features

- Ideal for WiMax, MESH Network, and Linear Applications
- P1dB: +32 dBm Typical
- Small Signal Gain: 34 dB Typical
- EVM: 2.5% at 26 dBm Linear (OFDM) P_{OUT}
- Integrated Detector
- Lead-Free 4 mm 16 lead PQFN Package
- 100% Matte Tin Plating over Copper
- Halogen-Free “Green” Mold Compound
- RoHS* Compliant and 260°C Reflow Compatible

Description

M/A-COM’s MAAPSS0103 RF power amplifier is a three stage GaAs MMIC which exhibits high gain and linearity performance in a lead-free 4 mm 16-lead PQFN surface mount plastic package. This product is designed for the 2.5 GHz IEEE 802.16 / WiMax band. The MAAPSS0103 also features an integrated power detector.

The MAAPSS0103 is fabricated using a high reliability GaAs HBT process to realize low current and high power functionality. The process features full passivation for increased performance and reliability.

Ordering Information ¹

Part Number	Package
MAAPSS0103TR-1000	1000 piece reel
MAAPSS0103TR-3000	3000 piece reel
MAAPSS0103SMB	Sample Test Board (Includes 5 Samples)

1. Reference Application Note M513 for reel size information.

Block Diagram

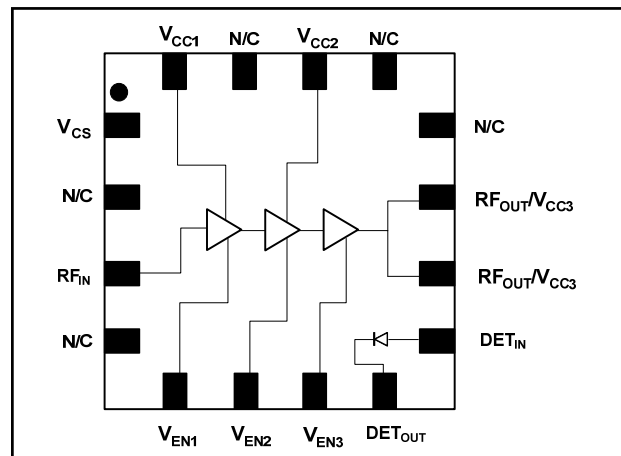

Pin Configuration

Pin No.	Pin Name	Description
1	V _{CS}	Bias Supply Voltage
2	N/C	No Connect
3	RF _{IN}	RF Input
4	N/C	No Connect
5	V _{EN1}	Power Enable
6	V _{EN2}	Power Enable
7	V _{EN3}	Power Enable
8	DET _{OUT}	Detector Output
9	DET _{IN}	Detector Input
10	RF _{OUT} /V _{CC3}	RF Output, 3rd Stage Supply
11	RF _{OUT} /V _{CC3}	RF Output, 3rd Stage Supply
12	N/C	No Connect
13	N/C	No Connect
14	V _{CC2}	2nd Stage Supply
15	N/C	No Connect
16	V _{CC1}	1st Stage Supply
17	Paddle ²	RF & DC Ground

2. The exposed pad centered on the package bottom must be connected to RF and DC ground.

* Restrictions on Hazardous Substances, European Union Directive 2002/95/EC.

**High Power Linear Amplifier
2.3 – 2.8 GHz**

**MAAPSS0103
V3**

Electrical Specifications: $T_A = +25\text{ }^\circ\text{C}$, $V_{CC} = 5.0\text{ V}$, $Z_0 = 50\text{ }\Omega$

Parameter	Test Conditions	Units	Min.	Typ.	Max.
Gain	2.5 GHz	dB	31	34	—
Gain Flatness	2.3 - 2.8 GHz	dB	—	± 1	—
Input Return Loss	2.3 - 2.8 GHz	dB	—	10	—
Output Return Loss	2.3 - 2.8 GHz	dB	—	10	—
Output P1dB	2.5 GHz	dBm	—	32	—
EVM ³	2.5 GHz, $P_{OUT} = 26\text{ dBm}$ OFDM, QAM-64, 54 Mbps	%	—	2.5	—
Enable Voltage	V_{EN}	V	—	2.8	—
Device / Supply Voltage	2.3 - 2.8 GHz	V	—	5	—
Quiescent Current Operating Current	2.5 GHz, No RF 2.5 GHz, $P_{OUT} = 26\text{ dBm}$	mA mA	— —	250 600	— 700
PAE	2.5 GHz, $P_{OUT} = 26\text{ dBm}$	%	—	14	—
Detector Output Range	2.5 GHz, $P_{OUT} = 14 - 28\text{ dBm}$, OFDM	V	—	0.5 - 2.0	—
Thermal Resistance	@ 85°C package paddle temperature	$^\circ\text{C/W}$	—	25	—

3. Includes system EVM of 0.8%.

Absolute Maximum Ratings^{4,5}

Parameter	Absolute Maximum
Input Power	+ 5 dBm
Operating Supply Voltage	+6.0 Volts
Operating Control Voltage	+3.6 Volts
Operating Temperature	-40°C to +85 °C
Channel Temperature	+150 °C
Storage Temperature	-40 °C to +150 °C

4. Exceeding any one or combination of these limits may cause permanent damage to this device.

5. M/A-COM does not recommend sustained operation near these survivability limits.

Handling Procedures

Please observe the following precautions to avoid damage:

Static Sensitivity

Gallium Arsenide Integrated Circuits are sensitive to electrostatic discharge (ESD) and can be damaged by static electricity. Proper ESD control techniques should be used when handling these devices.

**High Power Linear Amplifier
2.3 – 2.8 GHz**

**MAAPSS0103
V3**

Application Schematic

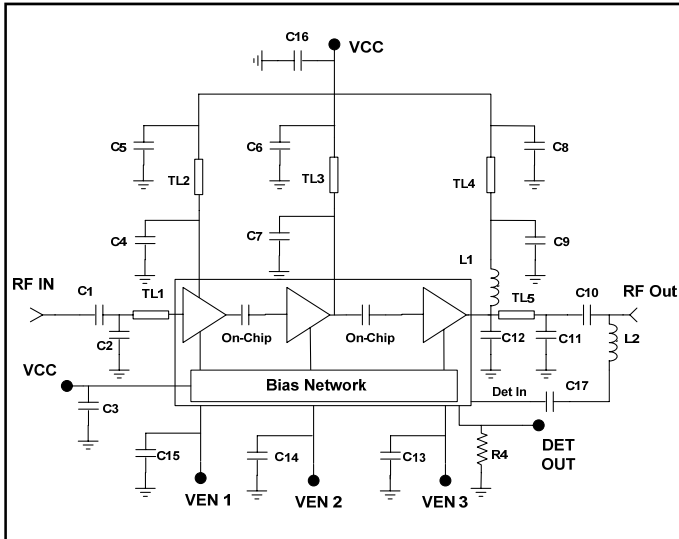

External Parts List

Component	Value	Case Size	Manufacturer
C1, C5, C6, C10, C17	1000 pF	0402	Murata
C2	1.8 pF	0402	Murata
C3, C8, C13, C14, C15	0.1 μ F	0402	Murata
C4, C7, C9	8 pF	0402	Murata
C11	2 pF	0402	Murata
C12	2.2 pF	0402	Murata
C16	3.3 μ F	1206	Kemet
L1	3.6 nH	0402	Coilcraft
L2	15 nH	0402	Coilcraft
R1,R2,R3	0 Ω	—	—
R4	100 k Ω	—	—
TL1	5.5 mm (L), 0.37 mm (W)	—	—
TL2, TL3	4 mm (L), 0.37 mm (W)	—	—
TL4	1.7 mm (L), 0.37 mm (W)	—	—
TL5	0.3 mm (L), 0.37 mm (W)	—	—

Sample Board ⁶

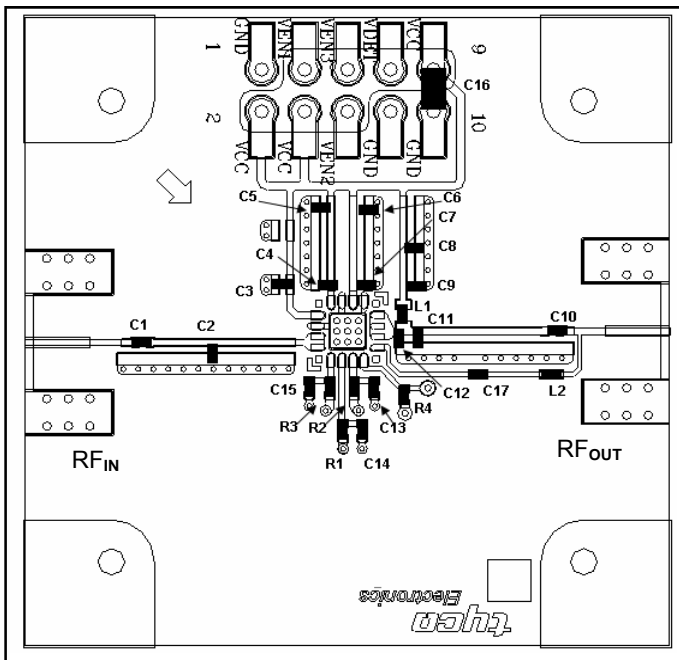

6. PCB Material FR4 - 50 Ω Line = 0.37 mm (W)

Typical Performance Curves: over temp

Gain

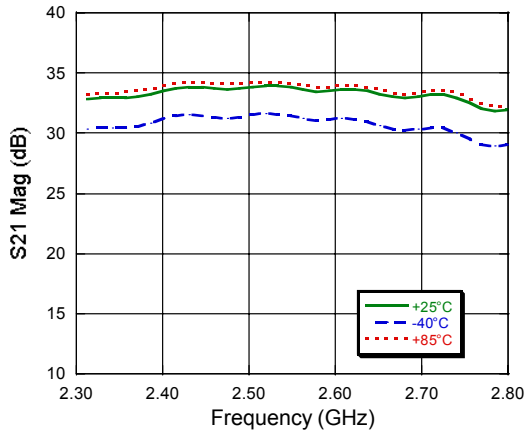

S11

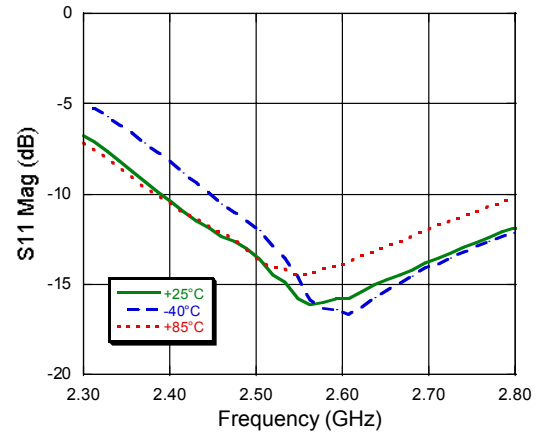

S22

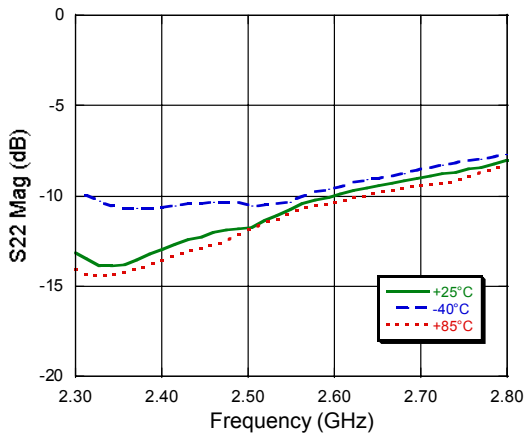

OIP3

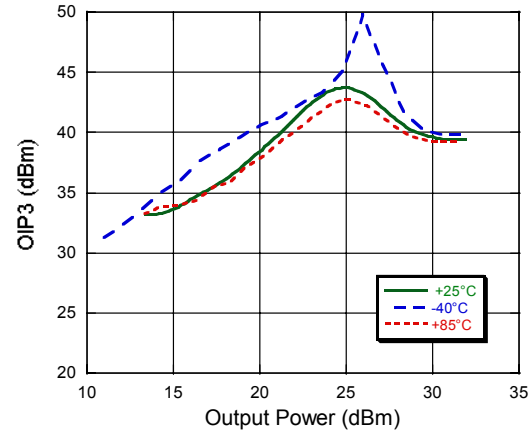

P1dB

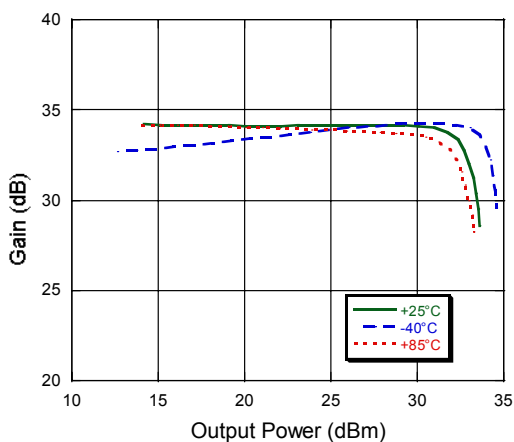

Current

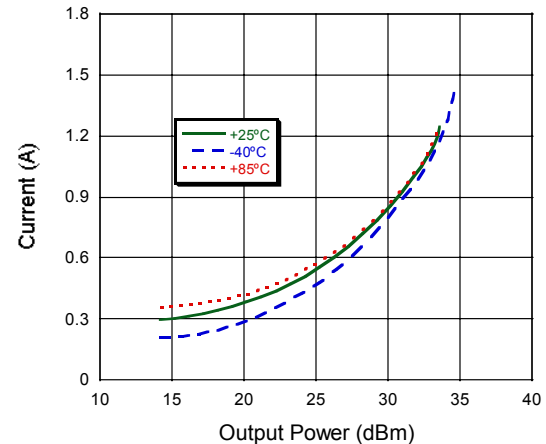

**High Power Linear Amplifier
2.3 – 2.8 GHz**

**MAAPSS0103
V3**

Typical Performance Curves: @ +25°C

EVM vs. Channel Power

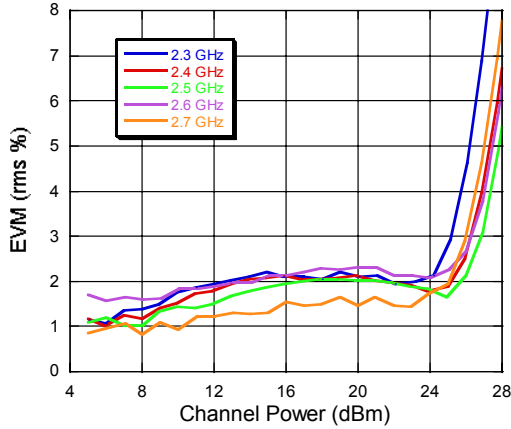

V_{DET} vs. Channel Power Over Temp @ 2.5 GHz

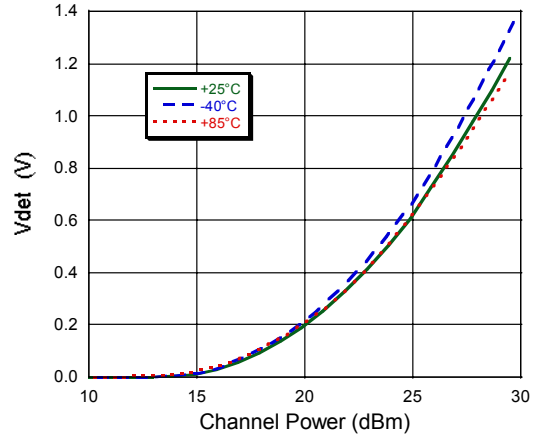

Current vs. Channel Power

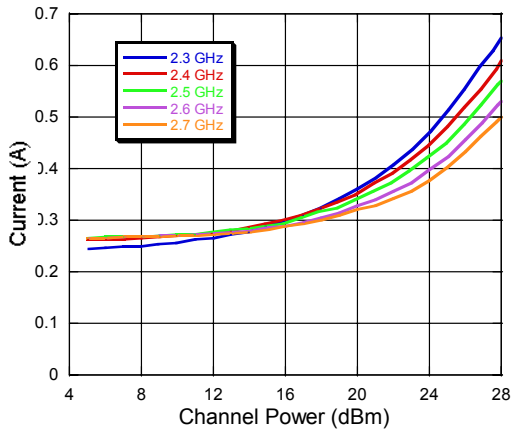

Current vs. Channel Power Over Temp @ 2.5 GHz

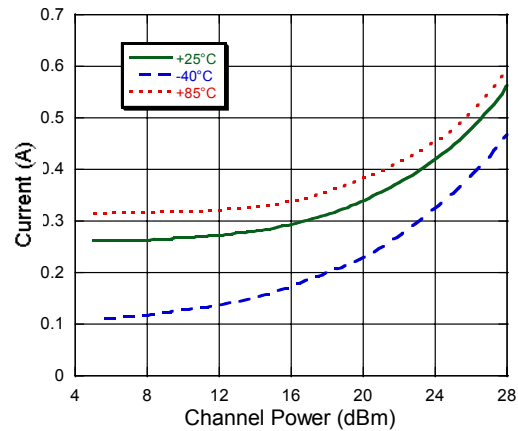

**High Power Linear Amplifier
2.3 – 2.8 GHz**

**MAAPSS0103
V3**

Lead-Free 4 mm 16-Lead PQFN†

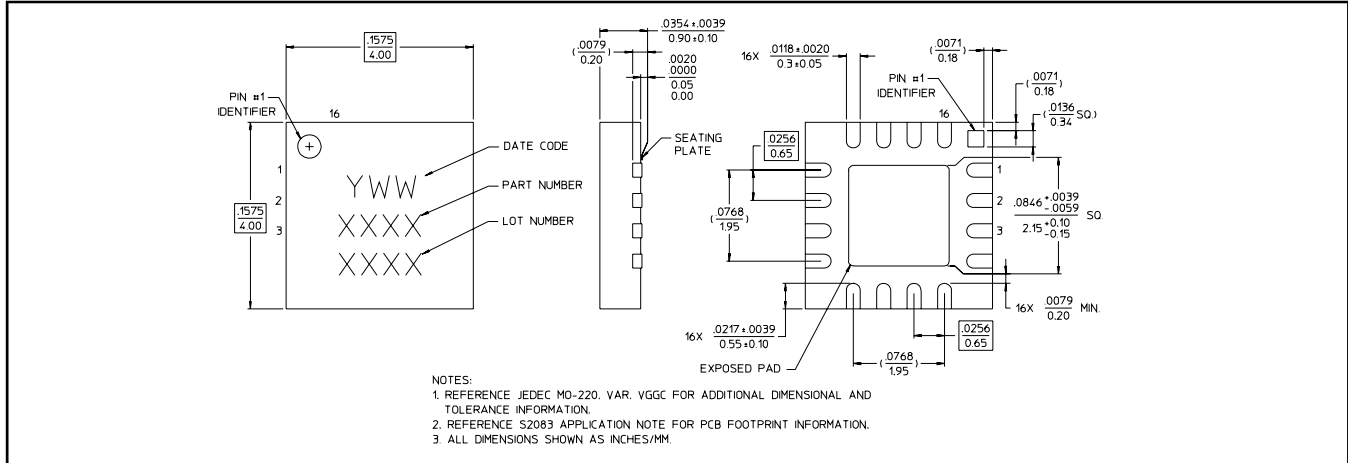

† Reference Application Note M538 for lead-free solder reflow recommendations.
 Meets JEDEC moisture sensitivity level 1 requirements.