

Features

- Ideal for DECT Applications
- Saturated Output Power: +26 dBm Typical
- Power Gain: 26 dB Typical
- Low Current: 400 mA at P_{SAT}
- Ramp Power Control
- Micro-Amp Shutdown
- Operates from 1.5 V to 4.0 V
- V_{EN} configurable for either 1.7 V or 2.5 V
- Lead-Free 3 mm 12-Lead PQFN Package
- 100% Matte Tin Plating over Copper
- Halogen-Free "Green" Mold Compound
- RoHS* Compliant 260°C Reflow Compatible

Description

The MAAPSS0071 is a three stage power amplifier designed for Cordless Telephone applications. This power amplifier is mounted in a standard outline, lead-free 3 mm 12-lead PQFN plastic package. The MAAPSS0071 features an integrated power enable control pin.

Ordering Information¹

Part Number	Package
MAAPSS0071	Bulk Packaging
MAAPSS0071TR-3000	3000 piece reel
MAAPSS0071SMB	Sample Test Board (Includes 5 Samples)

1. Reference Application Note M513 for reel size information.

Absolute Maximum Ratings^{2,3}

Parameter	Absolute Maximum
Input Power	+ 5 dBm
Operating Supply Voltage	+4.0 Volts
Operating Control Voltage	+3.0 Volts
Operating Temperature	-20°C to +85°C
Channel Temperature	+150°C
Storage Temperature	-40°C to +150°C

- Exceeding any one or combination of these limits may cause permanent damage to this device.
- M/A-COM does not recommend sustained operation near these survivability limits.

* Restrictions on Hazardous Substances, European Union Directive 2002/95/EC.

Functional Schematic

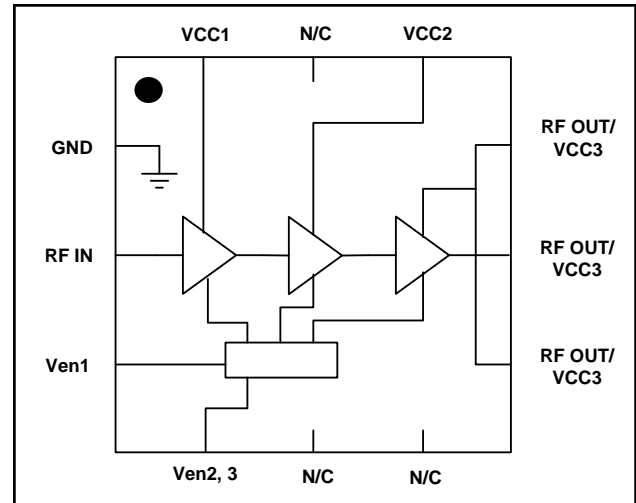

Pin Configuration

Pin No.	Pin Name	Description
1	GND	Ground
2	RF _{IN}	RF Input
3	V _{EN1}	Power Enable
4	V _{EN2,3}	Power Enable
5	N/C	No Connection
6	N/C	No Connection
7	RF _{OUT} / V _{CC3}	RF Output, 3rd Stage Supply
8	RF _{OUT} / V _{CC3}	RF Output, 3rd Stage Supply
9	RF _{OUT} / V _{CC3}	RF Output, 3rd Stage Supply
10	V _{CC2}	2nd Stage Supply
11	N/C	No Connection
12	V _{CC1}	1st Stage Supply
Pad ⁴	GND	RF & DC Ground

- The exposed pad centered on the package bottom must be connected to RF and DC ground.

Electrical Specifications:

Frequency = 1905 MHz, $P_{IN} = -2$ to 2 dBm, $V_{CC} = 2.4$ V, $V_{EN} = 2.5$ V, $T_A = 25$ °C, $Z_0 = 50\Omega$

Parameter	Test Conditions	Units	Min.	Typ.	Max
Input Return Loss	—	dB	—	15	—
Output Power	—	dBm	24	26	27
Power Flatness	$2.0 < V_{CC} < 3.0$ V	dB	—	3	—
PAE	—	%	—	45	—
Current	—	mA	—	400	500
Current, Off	$V_{EN} = 0$ V	μ A	—	3	10
Pdiss	$P_{OUT} = 26.0$ dBm	W	—	0.5	—
Control Pins	V_{EN} , Low	V	0	—	0.5
	V_{EN} , High	V	2.0	—	2.5
	Current	mA	—	2.0	4.0
Harmonics	2f	dBc	—	-35	—
	3f	dBc	—	-40	—
Forward Isolation	$V_{EN} = 0$ V	dB	—	39	—
Duty Cycle	—	%	—	—	100
Turn on/off time	Ton: RF burst to NTP-1	μ S	—	3	—
	Toff: NTP-1 to off	μ S	—	2	—
Stability	$+1.5V < V_{CC} < +3.5$ V, $P_{IN} = -2$ to 2 dBm, $VSWR < 6:1$ $-20^\circ\text{C} < T_C < +70^\circ\text{C}$, RBW = 3 MHz max hold		All spurs < -60 dBc		

Lead-Free 3 mm 12-Lead PQFN†

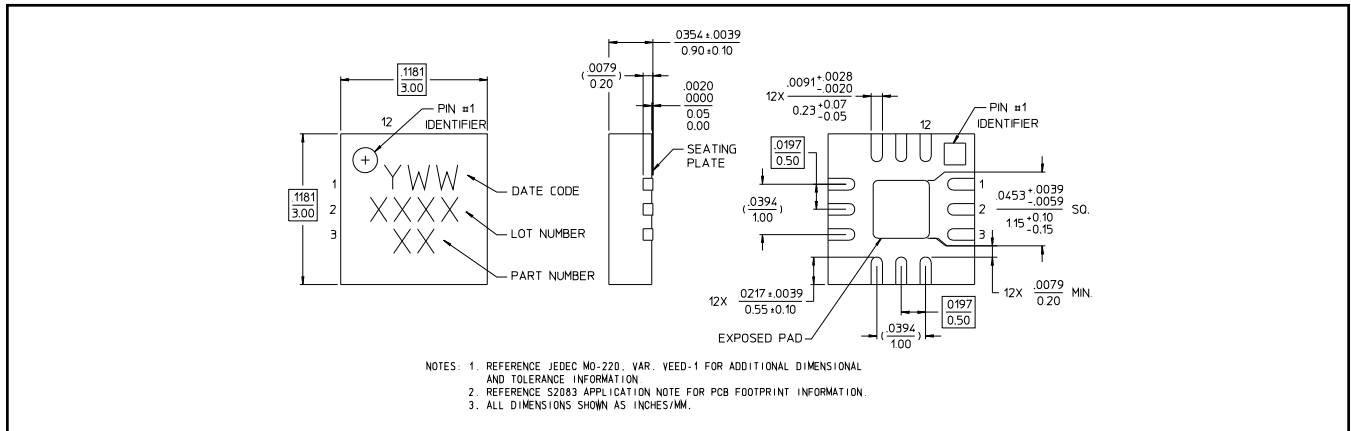

† Reference Application Note M538 for lead-free solder reflow recommendations.
Meets JEDEC moisture sensitivity level 1 requirements.

Operating the MAAPSS0071

The MAAPSS0071 can be damaged by electrostatic discharge (ESD). Use proper ESD control techniques when handling this device. To operate the MAAPSS0071, turn on the V_{CC} before V_{EN} for power on and turn off V_{CC} after V_{EN} for shutdown.

Evaluation Board Schematic

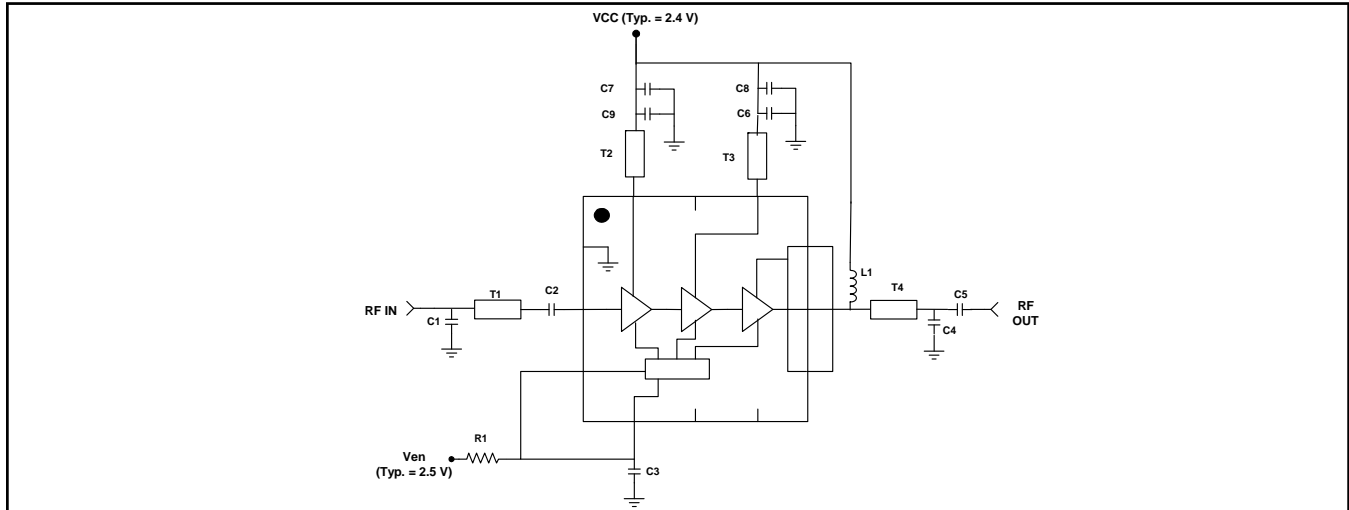

MAAPSS0071 External Parts List

Designator	Value	Footprint	Manufacturer	Part ID
C1	1 pF	0402	Murata	GRM1555C1H1R0CZ01B
C2, C4	3 pF	0402	Murata	GRM1555C1H3R0CZ01B
C3	22 nF	0402	Murata	GRM155R71C223KA01B
C5, C6	47 pF	0402	Murata	GRM1555C1H470JZ01B
C7, C8	100 nF	0402	Murata	GRM155F51C104ZA01B
C9	4 pF	0402	Murata	GRM155C1H4R0CZ01B
R1 (V _{EN} = 2.5 V)	470 Ohm	0402	KOA	RK73B1ET470J
R1 (V _{EN} = 1.7 V)	100 Ohm	0402	KOA	RK73B1ET101J
L1	10 nH	0402	Coilcraft	0402CS-10NXJB

Transmission Line Dimensions, 0.20 mm FR4

Designator	Length (mm) ⁵	Width (mm)
T1 ⁶	2.16	0.37
T2	2.54	0.37
T3	3.05	0.37
T4	3.94	0.37

5. From package edge to center of component.
6. T1 is measured from package edge (not C2) to the center of C1.

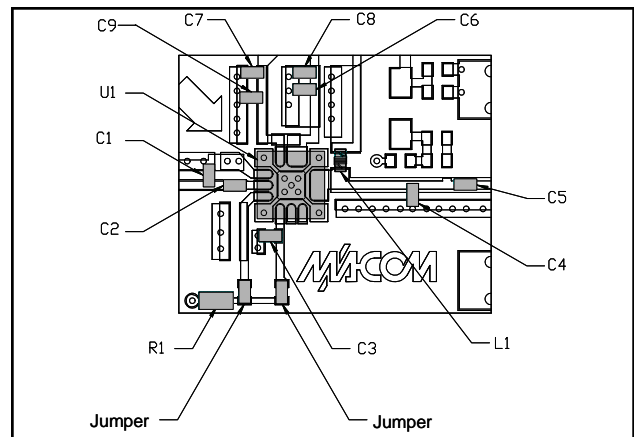

Typical Characteristics, $V_{EN} = 2.5\text{ V}$ (Using the supplied sample board BOM)

P_{OUT} , PAE, I_{CC} vs. P_{IN} @ 2.4 V, 1900 MHz

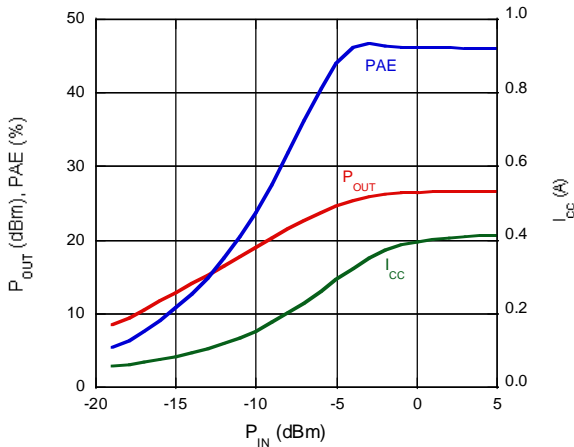

P_{OUT} , PAE, I_{CC} vs. V_{CC} @ 1900 MHz, $P_{IN} = 0\text{ dBm}$

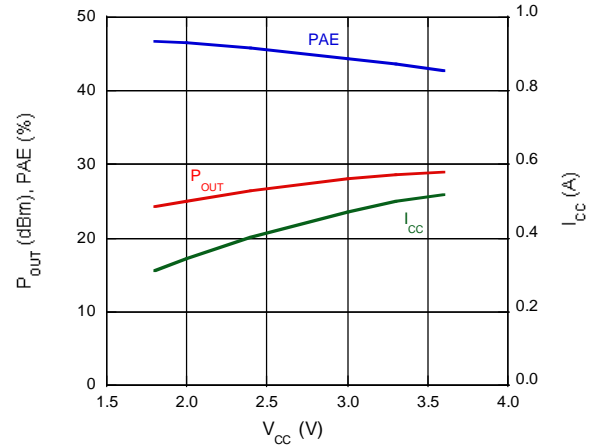

P_{OUT} vs. Temperature @ 1900 MHz, $P_{IN} = 0\text{ dBm}$

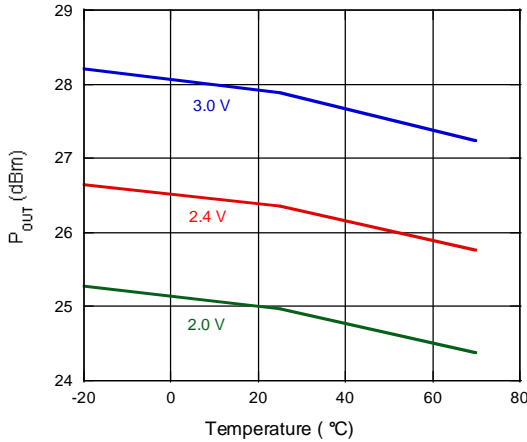

I_{CC} vs. Temperature @ 1900 MHz, $P_{IN} = 0\text{ dBm}$

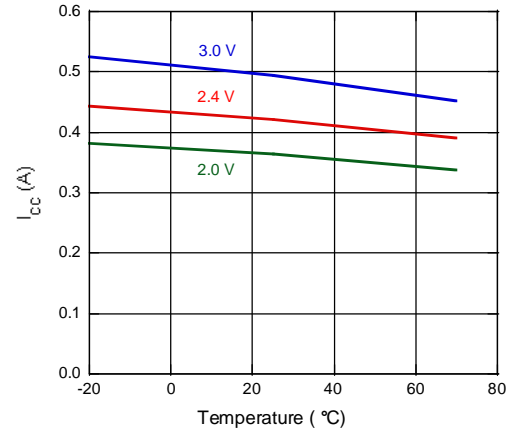

P_{OUT} vs. V_{CC} @ 1900 MHz, $P_{IN} = 0\text{ dBm}$

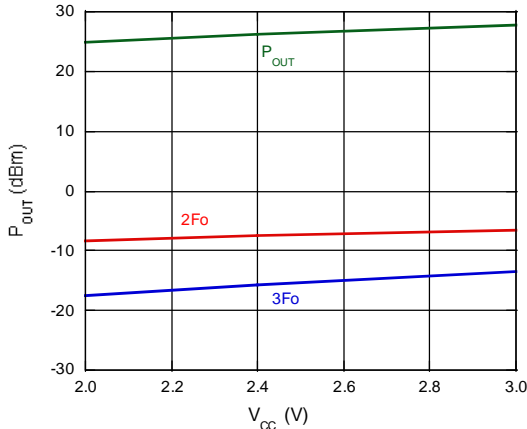

P_{OUT} , PAE, I_{CC} vs. Frequency @ $V_{CC} = 2.4\text{ V}$, $P_{IN} = 0\text{ dBm}$

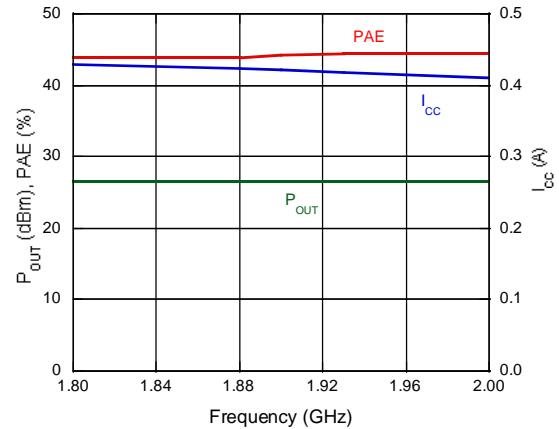

ADVANCED: Data Sheets contain information regarding a product M/A-COM Technology Solutions is considering for development. Performance is based on target specifications, simulated results, and/or prototype measurements. Commitment to develop is not guaranteed.
PRELIMINARY: Data Sheets contain information regarding a product M/A-COM Technology Solutions has under development. Performance is based on engineering tests. Specifications are typical. Mechanical outline has been fixed. Engineering samples and/or test data may be available. Commitment to produce in volume is not guaranteed.

- **North America** Tel: 800.366.2266 / Fax: 978.366.2266
- **Europe** Tel: 44.1908.574.200 / Fax: 44.1908.574.300
- **Asia/Pacific** Tel: 81.44.844.8296 / Fax: 81.44.844.8298

Visit www.macontech.com for additional data sheets and product information.

M/A-COM Technology Solutions Inc. and its affiliates reserve the right to make changes to the product(s) or information contained herein without notice.

Typical Characteristics (All data uses the supplied sample board BOM)

S_{21} vs. Frequency @ $V_{CC} = 2.4\text{ V}$, $V_{EN} = 2.5\text{ V}$

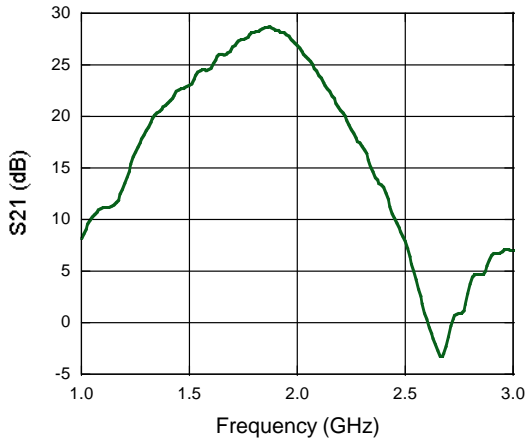

S_{22} , S_{11} vs. Frequency @ $V_{CC} = 2.4\text{ V}$, $V_{EN} = 2.5\text{ V}$

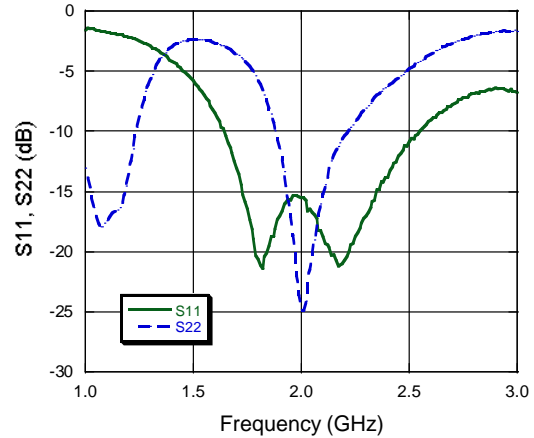

Typical Characteristics, $V_{EN} = 1.7\text{ V}$ (All data uses the supplied sample board BOM)

P_{OUT} , PAE, I_{CC} vs. P_{IN} @ 2.4 V , 1900 MHz

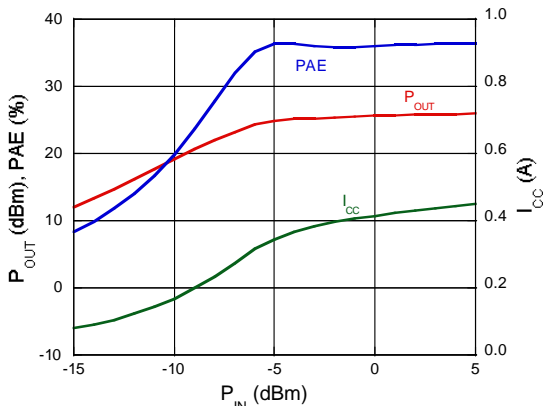

P_{OUT} , PAE, I_{CC} vs. V_{CC} @ 1900 MHz , $P_{IN} = 0\text{ dBm}$

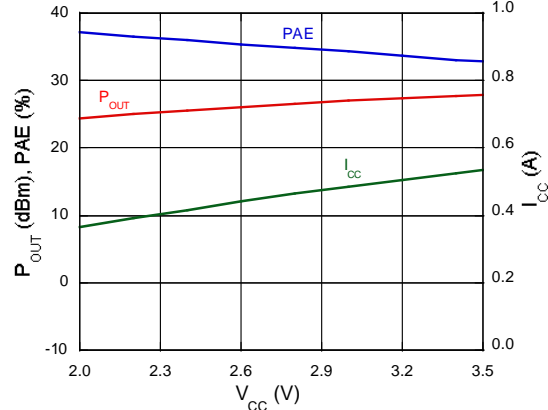

P_{OUT} , PAE, I_{CC} vs. Freq. @ 1900 MHz , $P_{IN} = 0\text{ dBm}$

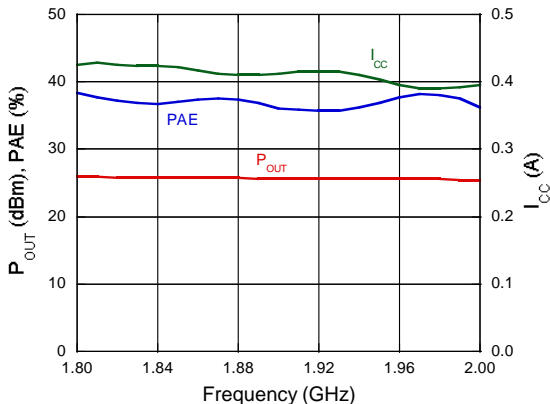

P_{OUT} vs. V_{EN} @ 2.4 V , 1900 MHz , $P_{IN} = 0\text{ dBm}$

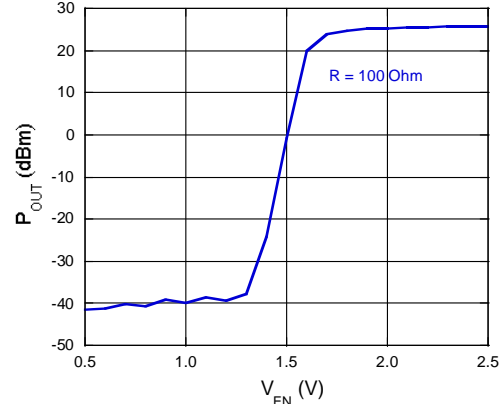

ADVANCED: Data Sheets contain information regarding a product M/A-COM Technology Solutions is considering for development. Performance is based on target specifications, simulated results, and/or prototype measurements. Commitment to develop is not guaranteed.
PRELIMINARY: Data Sheets contain information regarding a product M/A-COM Technology Solutions has under development. Performance is based on engineering tests. Specifications are typical. Mechanical outline has been fixed. Engineering samples and/or test data may be available. Commitment to produce in volume is not guaranteed.

- **North America** Tel: 800.366.2266 / Fax: 978.366.2266
- **Europe** Tel: 44.1908.574.200 / Fax: 44.1908.574.300
- **Asia/Pacific** Tel: 81.44.844.8296 / Fax: 81.44.844.8298

Visit www.macontech.com for additional data sheets and product information.

M/A-COM Technology Solutions Inc. and its affiliates reserve the right to make changes to the product(s) or information contained herein without notice.