

# S71NS-N MCP Products

**MirrorBit® 1.8 Volt-only Simultaneous Read/Write,  
Burst-mode Multiplexed Flash Memory**

**256 Mb (16 Mb x 16-bit), 128 Mb (8 Mb x 16-bit) and**

**64 Mb (4 Mb x 16-bit) with Multiplexed pSRAM**

**64 Mb (4 Mb x 16-bit), 32 Mb (2 Mb x 16-bit),**

**16 Mb (1 Mb x 16-bit) and 8Mb (512Kb x 16-bit)**

*Data Sheet (Advance Information)*

---



**Notice to Readers:** This document states the current technical specifications regarding the Spansion product(s) described herein. Each product described herein may be designated as Advance Information, Preliminary, or Full Production. See [Notice On Data Sheet Designations](#) for definitions.

## Notice On Data Sheet Designations

Spansion Inc. issues data sheets with Advance Information or Preliminary designations to advise readers of product information or intended specifications throughout the product life cycle, including development, qualification, initial production, and full production. In all cases, however, readers are encouraged to verify that they have the latest information before finalizing their design. The following descriptions of Spansion data sheet designations are presented here to highlight their presence and definitions.

### Advance Information

The Advance Information designation indicates that Spansion Inc. is developing one or more specific products, but has not committed any design to production. Information presented in a document with this designation is likely to change, and in some cases, development on the product may discontinue. Spansion Inc. therefore places the following conditions upon Advance Information content:

“This document contains information on one or more products under development at Spansion Inc. The information is intended to help you evaluate this product. Do not design in this product without contacting the factory. Spansion Inc. reserves the right to change or discontinue work on this proposed product without notice.”

### Preliminary

The Preliminary designation indicates that the product development has progressed such that a commitment to production has taken place. This designation covers several aspects of the product life cycle, including product qualification, initial production, and the subsequent phases in the manufacturing process that occur before full production is achieved. Changes to the technical specifications presented in a Preliminary document should be expected while keeping these aspects of production under consideration. Spansion places the following conditions upon Preliminary content:

“This document states the current technical specifications regarding the Spansion product(s) described herein. The Preliminary status of this document indicates that product qualification has been completed, and that initial production has begun. Due to the phases of the manufacturing process that require maintaining efficiency and quality, this document may be revised by subsequent versions or modifications due to changes in technical specifications.”

### Combination

Some data sheets contain a combination of products with different designations (Advance Information, Preliminary, or Full Production). This type of document distinguishes these products and their designations wherever necessary, typically on the first page, the ordering information page, and pages with the DC Characteristics table and the AC Erase and Program table (in the table notes). The disclaimer on the first page refers the reader to the notice on this page.

### Full Production (No Designation on Document)

When a product has been in production for a period of time such that no changes or only nominal changes are expected, the Preliminary designation is removed from the data sheet. Nominal changes may include those affecting the number of ordering part numbers available, such as the addition or deletion of a speed option, temperature range, package type, or  $V_{IO}$  range. Changes may also include those needed to clarify a description or to correct a typographical error or incorrect specification. Spansion Inc. applies the following conditions to documents in this category:

“This document states the current technical specifications regarding the Spansion product(s) described herein. Spansion Inc. deems the products to have been in sufficient production volume such that subsequent versions of this document are not expected to change. However, typographical or specification corrections, or modifications to the valid combinations offered may occur.”

Questions regarding these document designations may be directed to your local sales office.

# S71NS-N MCP Products

**MirrorBit® 1.8 Volt-only Simultaneous Read/Write,  
Burst-mode Multiplexed Flash Memory**  
256 Mb (16 Mb x 16-bit), 128 Mb (8 Mb x 16-bit) and  
64 Mb (4 Mb x 16-bit) with Multiplexed pSRAM  
64 Mb (4 Mb x 16-bit), 32 Mb (2 Mb x 16-bit),  
16 Mb (1 Mb x 16-bit) and 8Mb (512Kb x 16-bit)



*Data Sheet (Advance Information)*

## Features

- Power supply voltage of 1.7 V to 1.95 V
- Burst Speed: 66 MHz
- Package - MCP BGA: 0.5 mm ball pitch
  - 8.0 x 9.2 mm, 56 ball for NS064N and NS128N based MCPs
  - 10.0 x 11.0 mm, 60 ball for NS256N based MCPs
- Operating Temperature
  - Wireless, -25°C to +85°C

## General Description

The S71NS-N Series is a product line of stacked Multi-Chip Product (MCP) packages and consists of the following items:

- One or more S29NS-N flash memory die
- Mux burst-mode pSRAM

The products covered by this document are listed in the table below. For details about their specifications, please refer to their individual datasheet for further details.

	pSRAM				
	Density	8 Mb	16 Mb	32 Mb	64 Mb
Flash	64 Mb	S71NS064N80 (1)	S71NS064NA0	S71S064NB0	
	128 Mb (1)		S71NS128NA0	S71NS128NB0	S71NS128NC0
	256 Mb (1)			S71NS256NB0	S71NS256NC0

### Note

1. Not recommended for new designs. Use S71NS128P and S71NS256P instead.

For detailed specifications, please refer to the individual data sheets:

Document	Publication Identification Number
S29NS-N	S29NS-N_00
8 M Multiplexed pSRAM Type 1	muxpSRAM_06
16 M Multiplexed pSRAM Type 1	muxpSRAM_00
32 M Multiplexed pSRAM Type 3	muxpsram_04
64 M Multiplexed pSRAM Type 3	muxpsram_01

Publication Number S71NS-N\_00 Revision A Amendment 7 Issue Date March 26, 2008

This document contains information on one or more products under development at Spansion Inc. The information is intended to help you evaluate this product. Do not design in this product without contacting the factory. Spansion Inc. reserves the right to change or discontinue work on this proposed product without notice.

# 1. Ordering Information

The order number is formed by a valid combinations of the following:

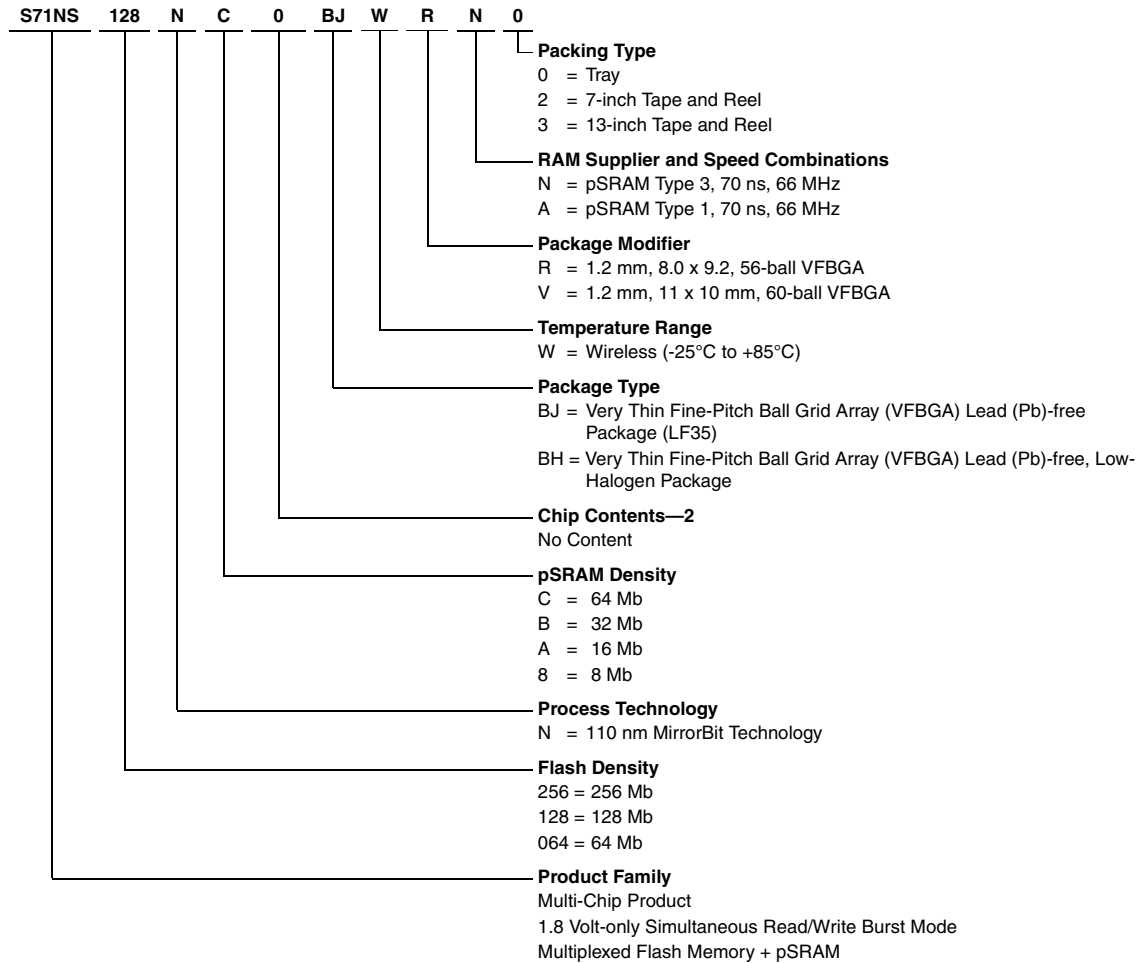

## 1.1 Valid Combinations

Valid Combinations list configurations planned to be supported in volume for this device. Consult your local sales office to confirm availability of specific valid combinations and to check on newly released combinations.

**Table 1.1** MCP Configurations and Valid Combinations

Base Ordering Part Number (1)	Package & Temperature	Model Number	Packing Type	pSRAM Type	Flash Speed Options	pSRAM Speed Options
S71NS064N80	BJW, BHW	RA	0, 2, 3	pSRAM Type 1	66 MHz	
S71NS064NA0		RA		pSRAM Type 1	66 MHz	
		RN		pSRAM Type 3	66 MHz	
S71NS064NB0		UN		pSRAM Type 1	Flash 66 MHz/ Asynchronous pSRAM	
S71NS128NA0 (2)	BJW	RN		pSRAM Type 3	66 MHz	
S71NS128NB0 (2)		RN		pSRAM Type 3	66 MHz	
S71NS128NC0 (2)		RN		pSRAM Type 3	66 MHz	
S71NS256NB0 (2)		VN		pSRAM Type 3	66 MHz	
S71NS256NC0 (2)		VN		pSRAM Type 3	66 MHz	
		VN	pSRAM Type 3	66 MHz		

**Note**

- The package marking omits the leading S from the ordering part number.
- Products no longer recommended for new designs. Please contact local Spansion sales representative for recommended migratory path.

## 2. Input/Output Descriptions

Table 2.1 identifies the input and output package connections provided on the device.

**Table 2.1** Input/Output Descriptions

Symbol	Description	Flash	RAM
AMAX – A16	Address inputs	X	X
ADQ15 – ADQ0	Multiplexed Address/Data	X	X
OE#	Output Enable input. Asynchronous relative to CLK for the Burst mode.	X	X
WE#	Write Enable input.	X	X
V <sub>SS</sub>	Ground	X	X
NC	No Connect; not connected internally	X	X
RDY	Ready output. Indicates the status of the Burst read. The WAIT# pin of the pSRAM is tied to RDY.	X	X
CLK	Clock input. In burst mode, after the initial word is output, subsequent active edges of CLK increment the internal address counter. Should be at V <sub>IL</sub> or V <sub>IH</sub> while in asynchronous mode	X	X
AVD#	Address Valid input. Indicates to device that the valid address is present on the address inputs. Low = for asynchronous mode, indicates valid address; for burst mode, causes starting address to be latched. High = device ignores address inputs	X	X
F-RST#	Hardware reset input. Low = device resets and returns to reading array data	X	
F-WP#	Hardware write protect input. At V <sub>IL</sub> , disables program and erase functions in the four outermost sectors. Should be at V <sub>IH</sub> for all other conditions.	X	
F-ACC	Accelerated input. At V <sub>IH</sub> , accelerates programming; automatically places device in unlock bypass mode. At V <sub>IL</sub> , disables all program and erase functions. Should be at V <sub>IH</sub> for all other conditions.	X	
R-CE1#	Chip-enable input for pSRAM.		X
F-CE#	Chip-enable input for Flash. Asynchronous relative to CLK for Burst Mode.	X	
R-CRE	Control Register Enable (pSRAM).		X
F-VCC	Flash 1.8 Volt-only single power supply.	X	
R-VCC	pSRAM Power Supply.		X
R-UB#	Upper Byte Control (pSRAM).		X
R-LB#	Lower Byte Control (pSRAM)		X
DNU	Do Not Use		

### 3. MCP Block Diagram

Figure 3.1 MCP Block Diagram

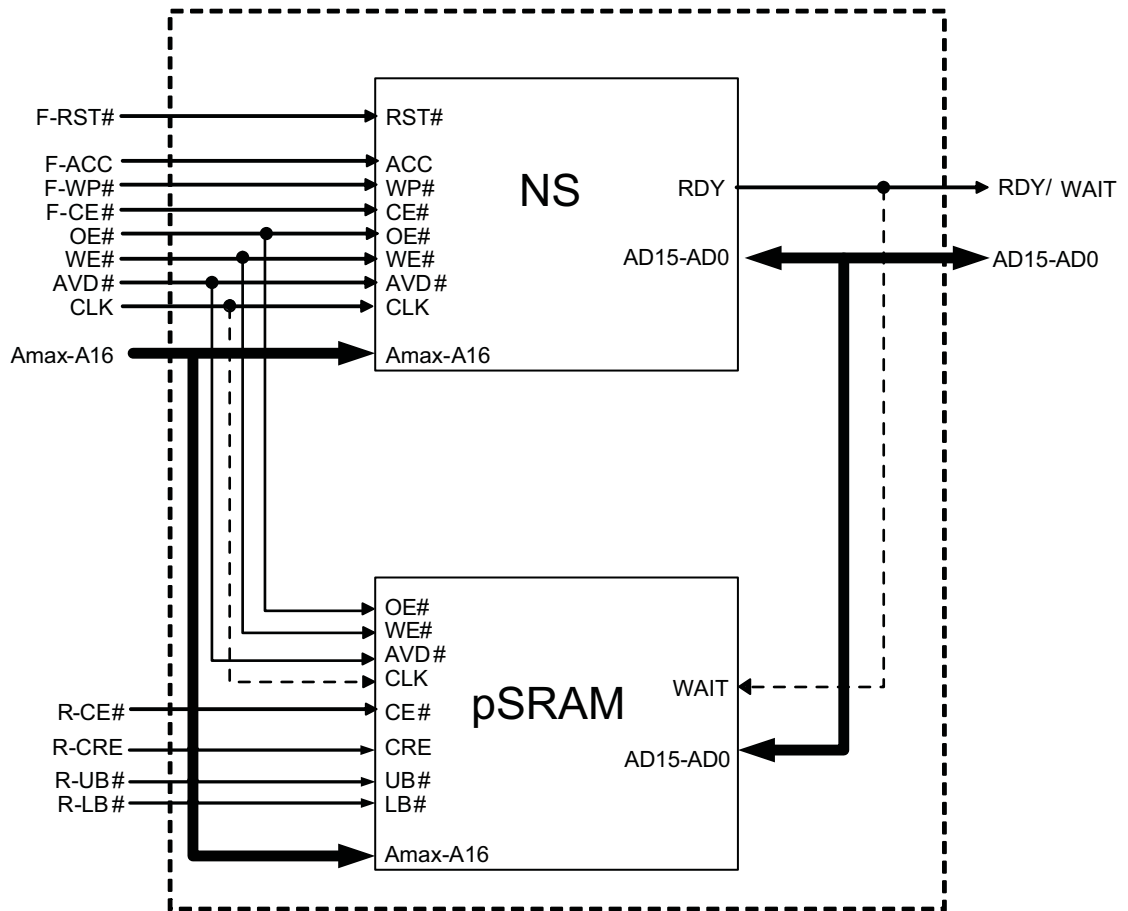

**Note**

The CLK and WAIT signals on the pSRAM are not present on the pSRAM Type 2; therefore, for those MCP's, those signals will only be connected to the NS flash, but not to the pSRAM. Also, on this pSRAM, the CRE signal will not be present at all.

### 4. Connection Diagrams/Physical Dimensions

This section contains the I/O designations and package specifications for the S71NS-N.

#### 4.1 Special Handling Instructions for FBGA Packages

Special handling is required for Flash Memory products in FBGA packages.

Flash memory devices in FBGA packages may be damaged if exposed to ultrasonic cleaning methods. The package and/or data integrity may be compromised if the package body is exposed to temperatures above 150°C for prolonged periods of time.

## 4.2 Connection Diagrams

### 4.2.1 pSRAM Based Pinout, 56-Ball, VFBGA

Figure 4.1 pSRAM Based Pinout, 56-Ball, VFBGA

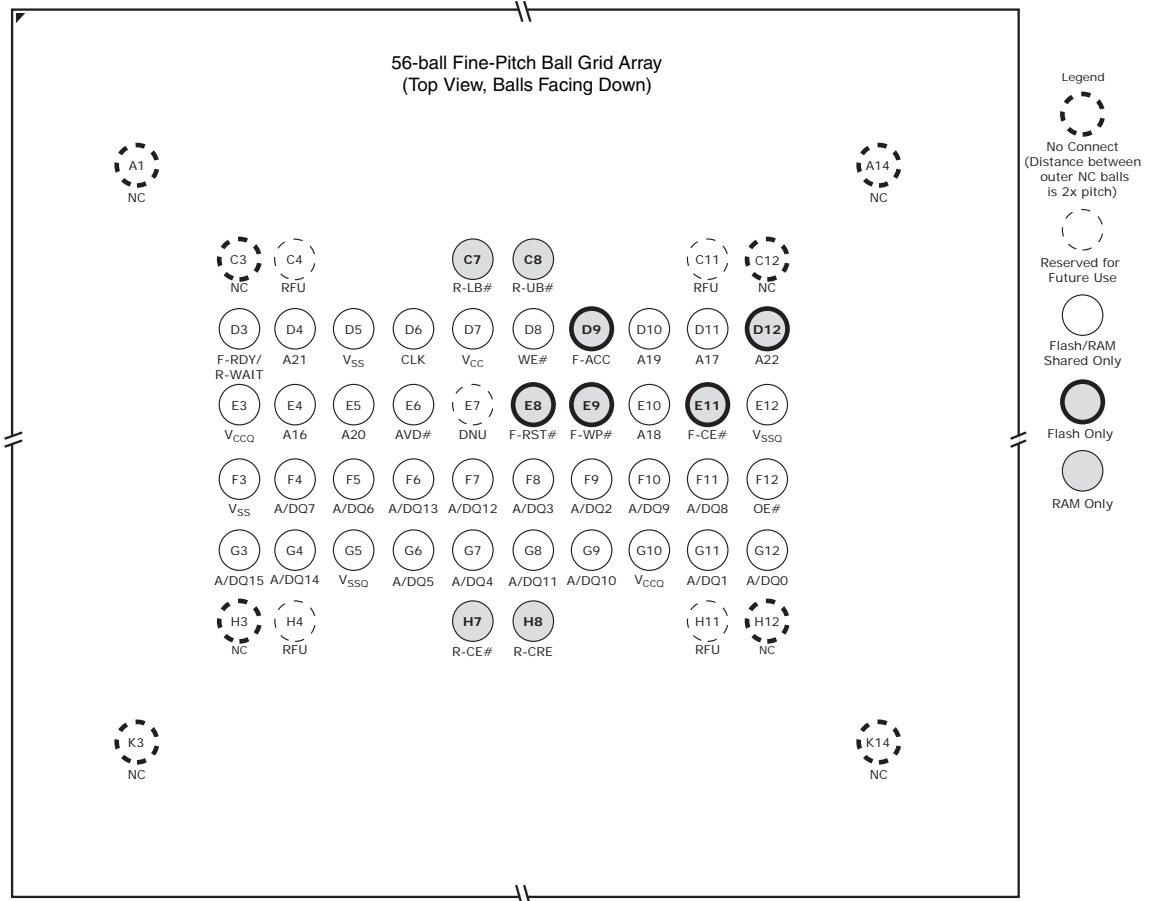

**Notes**

- Addresses are shared between Flash and RAM depending on the density of the pSRAM.
- CLK and WAIT signals are Flash only for the S71NS064NA0-RT, while on that MCP, the CRE signal won't exist.

MCP	Flash-Only Addresses	Shared Addresses	Shared ADQ Pins
S71NS128NC0	A22	A21-A16	ADQ15 – ADQ0
S71NS128NB0	A22-A21	A20-A16	
S71NS128NA0	A22-A20	A19-A16	
S71NS064NB0	A21	A20-A16	
S71NS064NA0	A21-A20	A19-A16	
S71NS064N80	A21-A19	A18-A16	

### 4.2.2 pSRAM Based Pinout, 60-Ball, VFBGA

Figure 4.2 pSRAM Based Pinout, 60-Ball, VFBGA

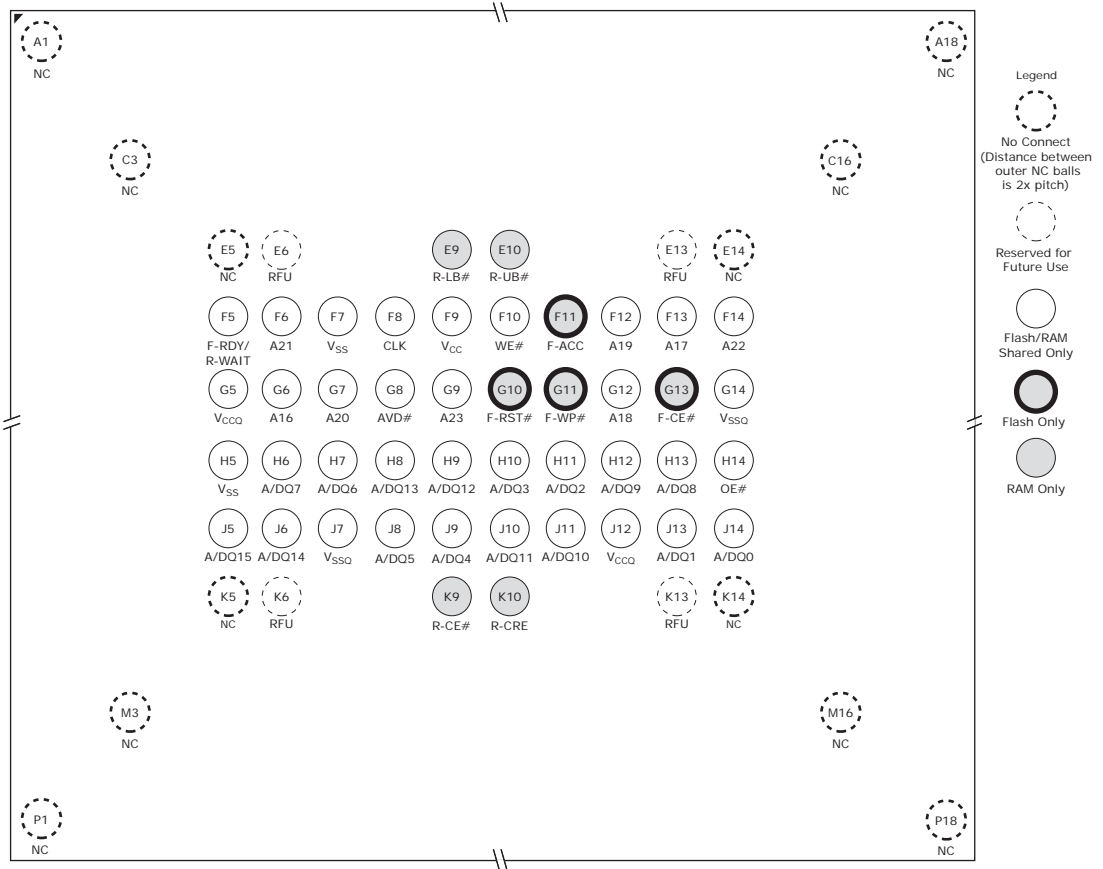

**Note**  
Addresses are shared between Flash and RAM depending on the density of the pSRAM.

MCP	Flash-Only Addresses	Shared Addresses	Shared ADQ Pins
S71NS256NC0	A23–A22	A21–A16	ADQ15–ADQ0
S71NS256NB0	A23–A21	A20–A16	ADQ15–ADQ0



### 4.2.3 Look Ahead Connection Diagram

**Figure 4.3** 112-ball x16 MUX NOR Flash + x16 MUX pSRAM on Shared Bus and x16 NAND Interface ORNAND on Bus 2

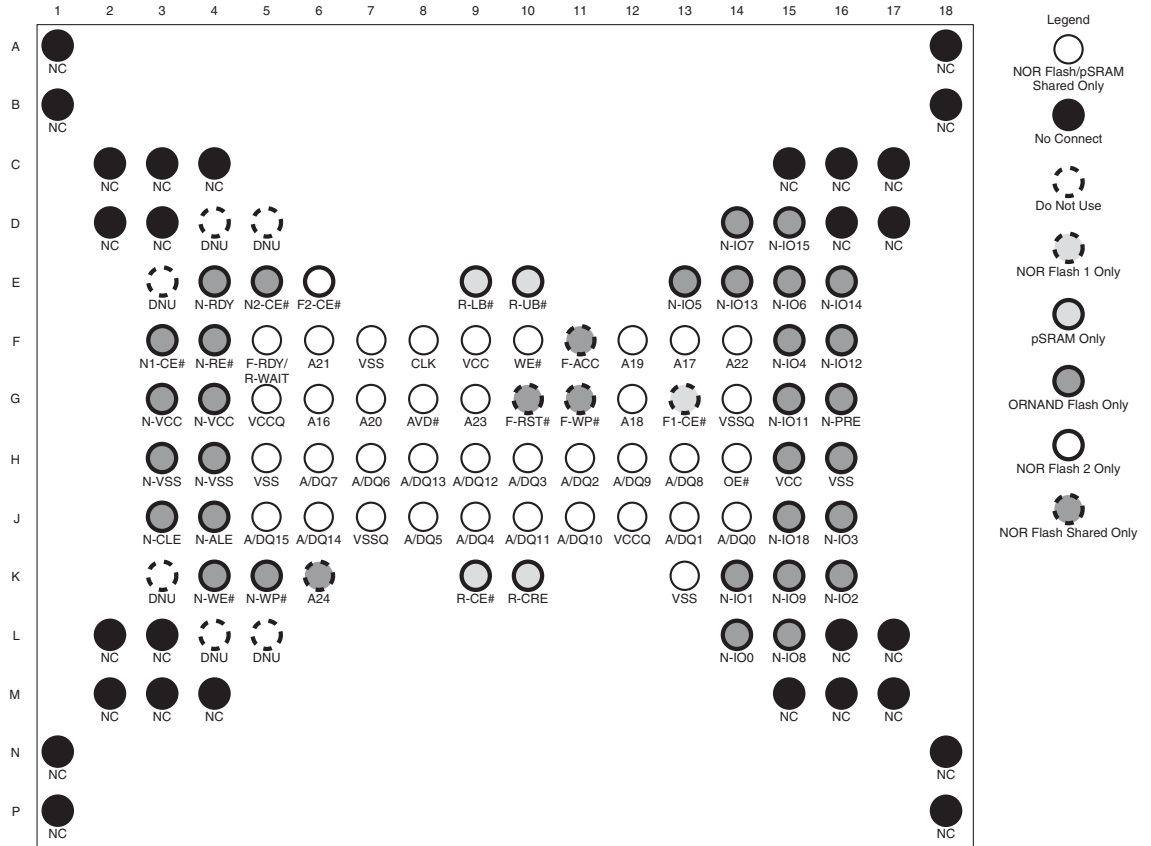

### 4.3 Physical Dimensions

#### 4.3.1 NLB056—9.2 x 8.0 mm, 56-ball VFBGA

Figure 4.4 NLB056—56-ball VFBGA

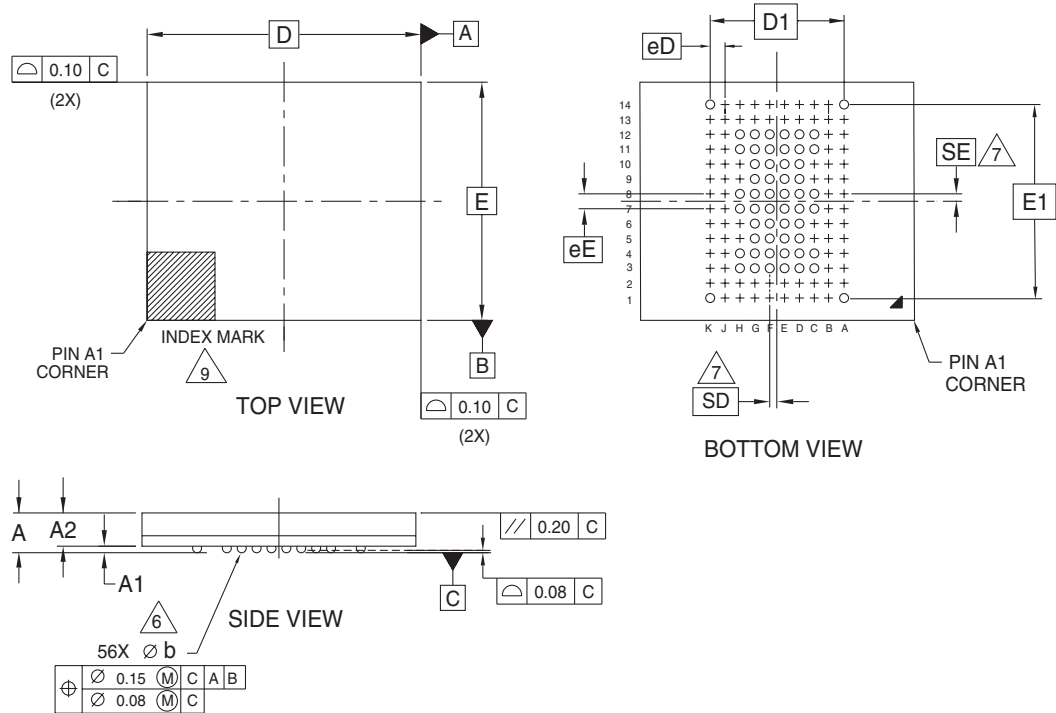

NOTES:

1. DIMENSIONING AND TOLERANCING METHODS PER ASME Y14.5M-1994.
2. ALL DIMENSIONS ARE IN MILLIMETERS.
3. BALL POSITION DESIGNATION PER JEP95, SECTION 4.3, SPP-010.
4. [e] REPRESENTS THE SOLDER BALL GRID PITCH.
5. SYMBOL "MD" IS THE BALL MATRIX SIZE IN THE "D" DIRECTION.  
SYMBOL "ME" IS THE BALL MATRIX SIZE IN THE "E" DIRECTION.  
n IS THE NUMBER OF POPULATED SOLDER BALL POSITIONS FOR MATRIX SIZE MD X ME.
6. DIMENSION "b" IS MEASURED AT THE MAXIMUM BALL DIAMETER IN A PLANE PARALLEL TO DATUM C.
7. SD AND SE ARE MEASURED WITH RESPECT TO DATUMS A AND B AND DEFINE THE POSITION OF THE CENTER SOLDER BALL IN THE OUTER ROW.  
WHEN THERE IS AN ODD NUMBER OF SOLDER BALLS IN THE OUTER ROW SD OR SE = 0.000.  
WHEN THERE IS AN EVEN NUMBER OF SOLDER BALLS IN THE OUTER ROW, SD OR SE = [e/2]
8. "+" INDICATES THE THEORETICAL CENTER OF DEPOPULATED BALLS.
9. A1 CORNER TO BE IDENTIFIED BY CHAMFER, LASER OR INK MARK, METALLIZED MARK INDENTATION OR OTHER MEANS.
10. OUTLINE AND DIMENSIONS PER CUSTOMER REQUIREMENT.

PACKAGE	NLB 056			
JEDEC	N/A			
D x E	9.20 mm x 8.00 mm PACKAGE			
SYMBOL	MIN	NOM	MAX	NOTE
A	---	---	1.20	PROFILE
A1	0.20	---	---	BALL HEIGHT
A2	0.85	---	0.97	BODY THICKNESS
D	9.20 BSC.			BODY SIZE
E	8.00 BSC.			BODY SIZE
D1	4.50 BSC.			MATRIX FOOTPRINT
E1	6.50 BSC.			MATRIX FOOTPRINT
MD	10			MATRIX SIZE D DIRECTION
ME	14			MATRIX SIZE E DIRECTION
n	56			BALL COUNT
$\varnothing$ b	0.25	0.30	0.35	BALL DIAMETER
eE	0.50 BSC.			BALL PITCH
eD	0.50 BSC.			BALL PITCH
SD / SE	0.25 BSC.			SOLDER BALL PLACEMENT
	A2 - A13, B1 - B14 C1, C2, C5, C6, C9, C10, C13, C14 D1, D2, D13, D14, E1, E2, E13, E14, F1, F2, F13, F14 G1, G2, G13, G14, H1, H2, H5, H6, H9, H10, H13, H14 J1 - J14, K2 - K13			DEPOPULATED SOLDER BALLS

3507, 16-038, 22 \ 7, 14.5

### 4.3.2 NLA060—11.0 x 10.0 mm, 60-ball VFBGA

Figure 4.5 NLA060—60-ball VFBGA

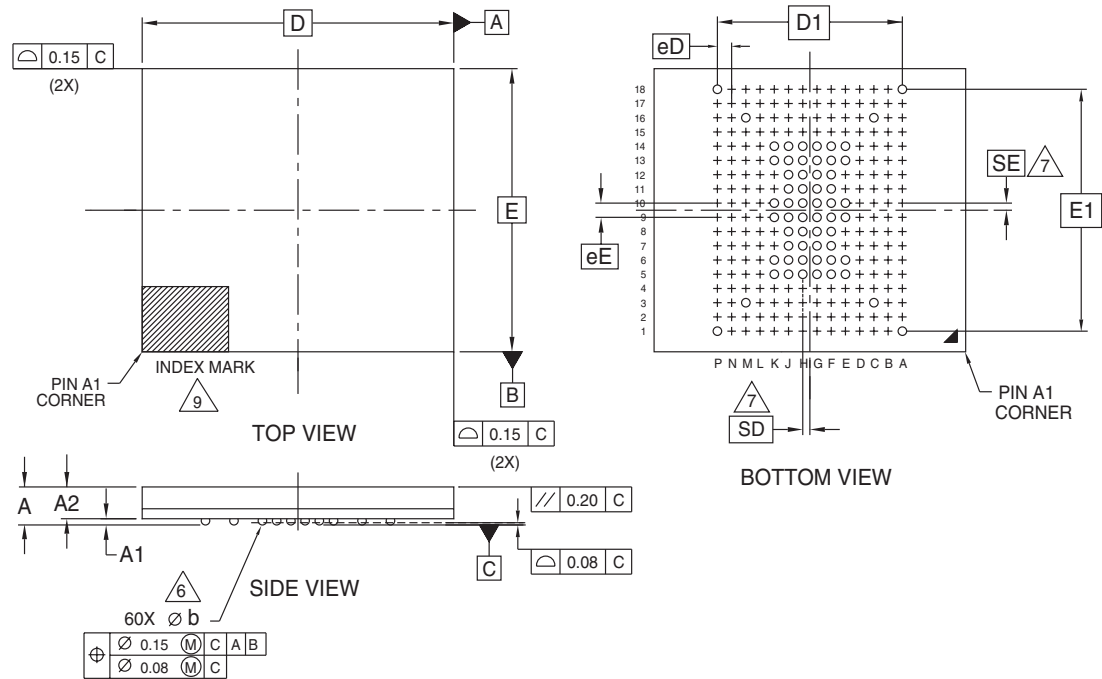

PACKAGE	NLA 060			
JEDEC	N/A			
D x E	10.95 mm x 9.95 mm PACKAGE			
SYMBOL	MIN	NOM	MAX	NOTE
A	---	---	1.20	PROFILE
A1	0.20	---	---	BALL HEIGHT
A2	0.85	---	0.97	BODY THICKNESS
D	10.95 BSC.			BODY SIZE
E	9.95 BSC.			BODY SIZE
D1	6.50 BSC.			MATRIX FOOTPRINT
E1	8.50 BSC.			MATRIX FOOTPRINT
MD	14			MATRIX SIZE D DIRECTION
ME	18			MATRIX SIZE E DIRECTION
n	60			BALL COUNT
⊙b	0.25	0.30	0.35	BALL DIAMETER
eE	0.50 BSC.			BALL PITCH
eD	0.50 BSC.			BALL PITCH
SD / SE	0.25 BSC.			SOLDER BALL PLACEMENT
	A0-A17, B1-B18, C1-C2, C4-C16, C17-C18 D1-D18, E1-E2, E3-E4, E7-E8, E11-E12, E15-E16, E17-E18 F1-F2, F3-F4, F15-F16, F17-F18, G1-G2, G3-G4, G15-G16, G17-G18 H1-H2, H3-H4, H15-H16, H17-H18, J1-J2, J3-J4, J15-J16, J17-J18 K1-K2, K3-K4, K7-K8, K11-K12, K15-K16, K17-K18 L1-L18, M1-M2, M4-M15, M17-M18, N1-N18, P5-P17			DEPOPULATED SOLDER BALLS

NOTES:

- DIMENSIONING AND TOLERANCING METHODS PER ASME Y14.5M-1994.
- ALL DIMENSIONS ARE IN MILLIMETERS.
- BALL POSITION DESIGNATION PER JEP95, SECTION 4.3, SPP-010.
- $e$  REPRESENTS THE SOLDER BALL GRID PITCH.
- SYMBOL "MD" IS THE BALL MATRIX SIZE IN THE "D" DIRECTION.  
SYMBOL "ME" IS THE BALL MATRIX SIZE IN THE "E" DIRECTION.  
n IS THE NUMBER OF POPULATED SOLDER BALL POSITIONS FOR MATRIX SIZE MD X ME.
- DIMENSION "b" IS MEASURED AT THE MAXIMUM BALL DIAMETER IN A PLANE PARALLEL TO DATUM C.
- SD AND SE ARE MEASURED WITH RESPECT TO DATUMS A AND B AND DEFINE THE POSITION OF THE CENTER SOLDER BALL IN THE OUTER ROW.
- WHEN THERE IS AN ODD NUMBER OF SOLDER BALLS IN THE OUTER ROW SD OR SE = 0.000.
- WHEN THERE IS AN EVEN NUMBER OF SOLDER BALLS IN THE OUTER ROW, SD OR SE =  $e/2$
- "+" INDICATES THE THEORETICAL CENTER OF DEPOPULATED BALLS.
- A1 CORNER TO BE IDENTIFIED BY CHAMFER, LASER OR INK MARK, METALLIZED MARK INDENTATION OR OTHER MEANS.
- OUTLINE AND DIMENSIONS PER CUSTOMER REQUIREMENT.

3483 \ 16-038.22 \ 3.11.5

## 5. Revision History

Section	Description
<b>Revision A (January 3, 2006)</b>	
	Initial Release under Publication Identification Number S71NS128NC0_01
<b>Revision A1 (March 1, 2006)</b>	
Global	Changed the Publication Identification Number from S71NS128NC0_01 to S71NS-N_00 Added the MCP S71NS064NA0
<b>Revision A2 (June 13, 2006)</b>	
Connection Diagrams	Corrected the grid reference for 56-ball connection diagram
<b>Revision A3 (October 10, 2006)</b>	
Global	Added the S71NS064NA0-RT - the one using pSRAM Type 2
<b>Revision A4 (December 22, 2006)</b>	
Global	Added S71NS064NA0-RA, S71NS064N80-RA Deleted S71NS064NA0-RT Added note to recommend S71NS128P and S71NS256P for new designs
<b>Revision A5 (March 2, 2007)</b>	
Ordering Information	Revised Ordering Information and Valid Combinations for S71NS064N80
<b>Revision A6 (December 19, 2007)</b>	
Global	Added ordering information and valid combinations for S71NS064NB0
<b>Revision A7 (March 26, 2008)</b>	
Ordering Information	Added Low-Halogen package option for NS064N MCPs Added Note 2 for NS128N and NS256N MCPs

**Colophon**

The products described in this document are designed, developed and manufactured as contemplated for general use, including without limitation, ordinary industrial use, general office use, personal use, and household use, but are not designed, developed and manufactured as contemplated (1) for any use that includes fatal risks or dangers that, unless extremely high safety is secured, could have a serious effect to the public, and could lead directly to death, personal injury, severe physical damage or other loss (i.e., nuclear reaction control in nuclear facility, aircraft flight control, air traffic control, mass transport control, medical life support system, missile launch control in weapon system), or (2) for any use where chance of failure is intolerable (i.e., submersible repeater and artificial satellite). Please note that Spansion will not be liable to you and/or any third party for any claims or damages arising in connection with above-mentioned uses of the products. Any semiconductor devices have an inherent chance of failure. You must protect against injury, damage or loss from such failures by incorporating safety design measures into your facility and equipment such as redundancy, fire protection, and prevention of over-current levels and other abnormal operating conditions. If any products described in this document represent goods or technologies subject to certain restrictions on export under the Foreign Exchange and Foreign Trade Law of Japan, the US Export Administration Regulations or the applicable laws of any other country, the prior authorization by the respective government entity will be required for export of those products.

**Trademarks and Notice**

The contents of this document are subject to change without notice. This document may contain information on a Spansion product under development by Spansion. Spansion reserves the right to change or discontinue work on any product without notice. The information in this document is provided as is without warranty or guarantee of any kind as to its accuracy, completeness, operability, fitness for particular purpose, merchantability, non-infringement of third-party rights, or any other warranty, express, implied, or statutory. Spansion assumes no liability for any damages of any kind arising out of the use of the information in this document.

Copyright © 2007-2008 Spansion Inc. All rights reserved. Spansion®, the Spansion Logo, MirrorBit®, MirrorBit® Eclipse™, ORNAND™, ORNAND2™, HD-SIM™ and combinations thereof, are trademarks of Spansion LLC in the US and other countries. Other names used are for informational purposes only and may be trademarks of their respective owners.