

Features

- ◆ 5 Watt Saturated Output Power Level
- ◆ MSAG™ Process
- ◆ Proven Manufacturability and Reliability
 - No Airbridges
 - Polyimide Scratch Protection
 - No Hydrogen Poisoning Susceptibility

Description

The MAAPGM0063-Die is a 3-stage power amplifier with on-chip bias networks. This product is fully matched to 50 ohms on both the input and output. It can be used as a power amplifier stage or as a driver stage in high power applications.

Fabricated using M/A-COM's repeatable, high performance and highly reliable GaAs Multifunction Self-Aligned Gate MESFET Process, each device is 100% RF tested on wafer to ensure performance compliance.

M/A-COM's MSAG™ process features robust silicon-like manufacturing processes, planar processing of ion implanted transistors, multiple implant capability enabling power, low-noise, switch and digital FETs on a single chip, and polyimide scratch protection for ease of use with automated manufacturing processes. The use of refractory metals and the absence of platinum in the gate metal formulation prevents hydrogen poisoning when employed in hermetic packaging.

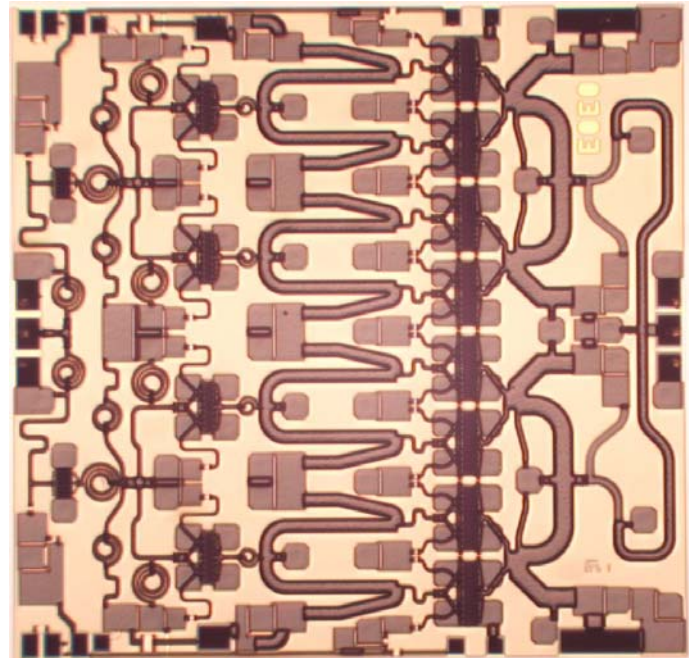

Primary Applications

- ◆ Military Radar
- ◆ Weather Radar

Electrical Characteristics: $T_B = 40^\circ\text{C}^1$, $Z_0 = 50\Omega$, $V_{DD} = 10\text{V}$, $I_{DQ} = 1.4\text{ A}^2$, $P_{in} = 16\text{ dBm}$

Parameter	Symbol	Typical	Units
Bandwidth	f	8.5-11.0	GHz
Output Power	P_{OUT}	37	dBm
Power Added Efficiency	PAE	32	%
1-dB Compression Point	P1dB	36	dBm
Small Signal Gain	G	25	dB
Input VSWR	VSWR	2.5:1	
Output VSWR	VSWR	2.3:1	
Gate Supply Current	I_{GG}	< 20	mA
Drain Supply Current	I_{DD}	< 2.0	A

1. $T_B = \text{MMIC Base Temperature}$
2. Adjust V_{GG} between -2.4 and -1.5V to achieve I_{DQ} indicated.

1

M/A-COM Inc. and its affiliates reserve the right to make changes to the product(s) or information contained herein without notice. M/A-COM makes no warranty, representation or guarantee regarding the suitability of its products for any particular purpose, nor does M/A-COM assume any liability whatsoever arising out of the use or application of any product(s) or information.

- **North America** Tel: 800.366.2266 / Fax: 978.366.2266
- **Europe** Tel: 44.1908.574.200 / Fax: 44.1908.574.300
- **Asia/Pacific** Tel: 81.44.844.8296 / Fax: 81.44.844.8298

Visit www.macom.com for additional data sheets and product information.

Maximum Operating Conditions ³

Parameter	Symbol	Absolute Maximum	Units
Input Power	P _{IN}	22.0	dBm
Drain Supply Voltage	V _{DD}	+12.0	V
Gate Supply Voltage	V _{GG}	-3.5	V
Quiescent Drain Current (No RF, 40% Idss)	I _{DQ}	2.50	A
Quiescent DC Power Dissipation (No RF)	P _{DISS}	13.0	W
Junction Temperature	T _J	180	°C
Storage Temperature	T _{STG}	-55 to +150	°C
Die Attach Temperature		310	°C

3. Operation outside of these ranges may reduce product reliability. Operation at other than the typical values may result in performance outside the guaranteed limits.

Recommended Operating Conditions

Characteristic	Symbol	Min	Typ	Max	Unit
Drain Supply Voltage	V _{DD}	8.0	10.0	11.0	V
Gate Supply Voltage	V _{GG}	-2.4	-2.0	-1.6	V
Input Power	P _{IN}		16.0	19.0	dBm
Junction Temperature	T _J			150	°C
Thermal Resistance	Θ _{JC}		6.1		°C/W
MMIC Base Temperature	T _B			Note 4	°C

4. Maximum MMIC Base Temperature = 150°C — Θ_{JC} * V_{DD} * I_{DQ}

Operating Instructions

This device is static sensitive. Please handle with care. To operate the device, follow these steps.

1. Apply V_{GG} = -2 V, V_{DD} = 0 V.
2. Ramp V_{DD} to desired voltage, typically 10 V.
3. Adjust V_{GG} to set I_{DQ}.
4. Set RF input.
5. Power down sequence in reverse. Turn V_{GG} off last.



8.5-11.0 GHz, 5W Power Amplifier

MAAPGM0063-DIE

RO-P-DS-3094
Preliminary Datasheet

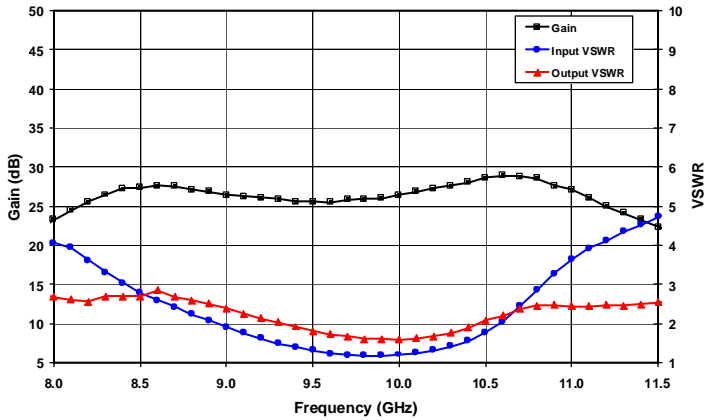

Figure 1. Small Signal Gain and VSWR vs. Frequency at $V_{DD} = 10V$.

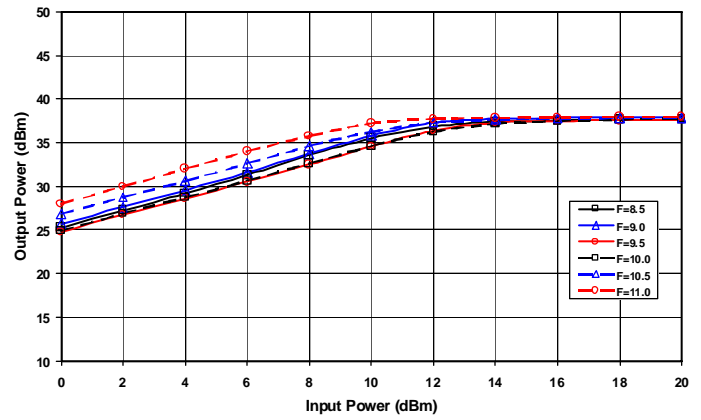

Figure 2. Output Power vs. Input Power at $V_{DD} = 10V$.

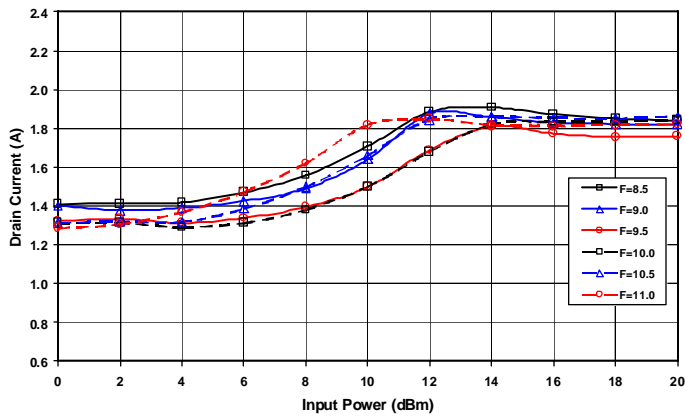

Figure 3. Drain Current vs. Input Power at $V_{DD} = 10V$.

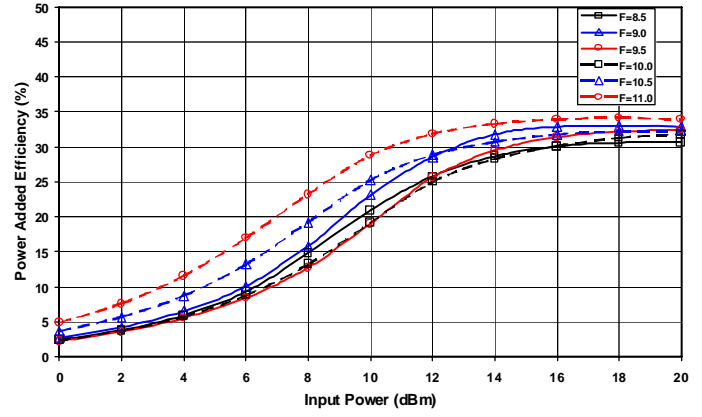

Figure 4. PAE vs. Input Power at $V_{DD} = 10V$.

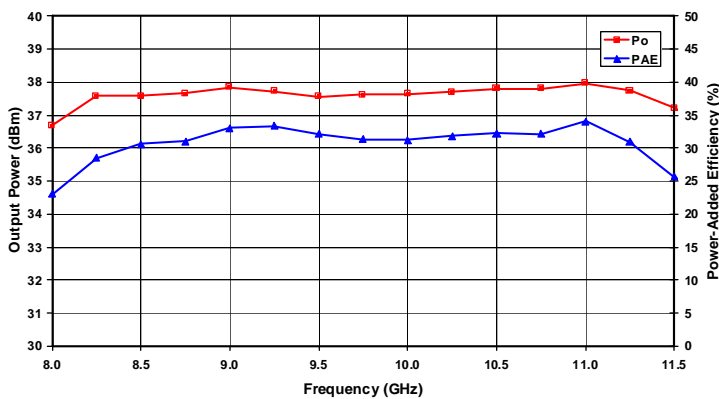

Figure 5. Output Power and Power Added Efficiency vs. Frequency at $V_{DD} = 10V$ and $P_{in} = 16 \text{ dBm}$.

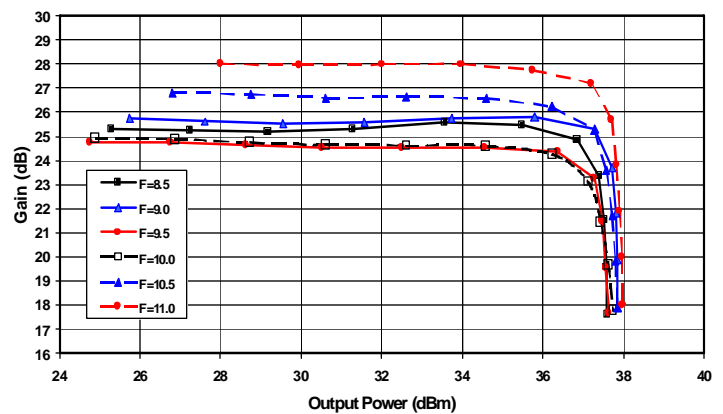

Figure 6. Comparison Curves, Gain vs. Output Power at $V_{DD} = 10V$.

Mechanical Information

Chip Size: 4.301 x 4.428. x 0.075 mm (169 x 174 x 3 mils)

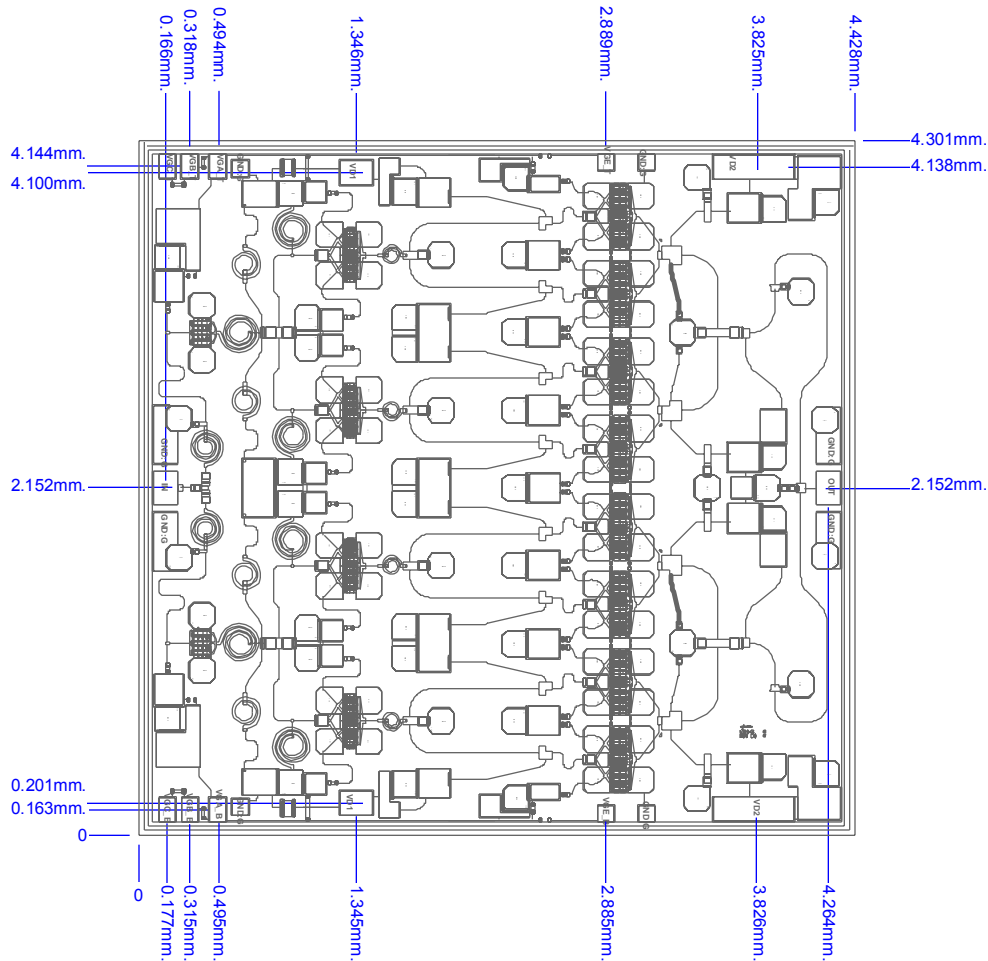

Figure 7. Die Layout.

Bond Pad Dimensions

Pad	Size (µm)	Size (mils)
RF In and Out	200 x 150	8 x 6
DC Drain Supply Voltage V_{DD}	200 x 150	8 x 6
DC Gate Supply Voltage V_{GG}	150 x 150	6 x 6

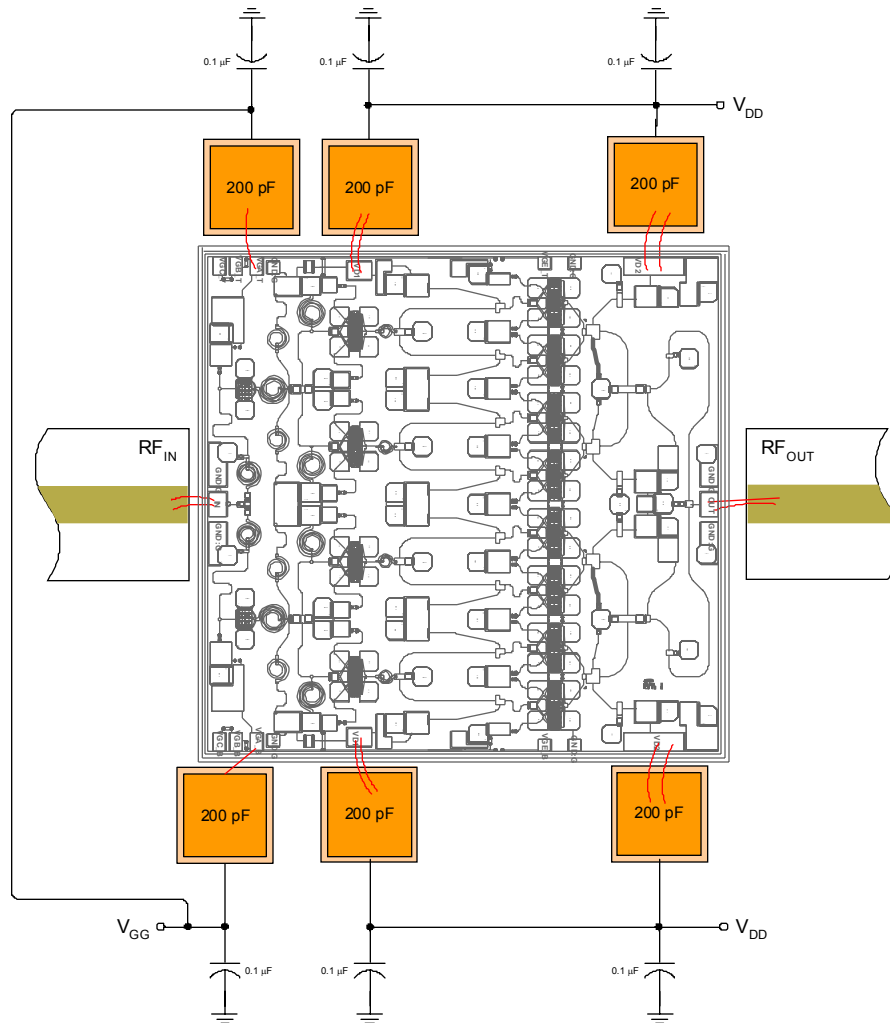

Figure 8. Recommended bonding diagram for pedestal mount.
Support circuitry typical of MMIC characterization fixture for CW test-

Assembly Instructions:

Die attach: Use AuSn (80/20) 1-2 mil. preform solder. Limit time @ 300 °C to less than 5 minutes.

Wirebonding: Bond @ 160 °C using standard ball or thermal compression wedge bond techniques. For DC pad connections, use either ball or wedge bonds. For best RF performance, use wedge bonds of shortest length, although ball bonds are also acceptable.

Biasing Note: Must apply negative bias to V_{GG} before applying positive bias to V_{DD} to prevent damage to amplifier.