

2.5-5.5 GHz 1.6W Power Amplifier

MAAPGM0035S

RO-P-DS-3088 B

Features

- ◆ 1.6 Watt Saturated Output Power Level
- ◆ Variable Drain Voltage (4-10V) Operation
- ◆ MSAG™ MESFET Process
- ◆ High Performance Ceramic Bolt Down Package

Primary Applications

- ◆ WLL
- ◆ MMDS
- ◆ SatCom

Description

The MAAPGM0035S is a packaged, 2-stage, 1.6 W power amplifier with on-chip bias networks in a bolt down ceramic package, allowing easy assembly. This product is fully matched to 50 ohms on both the input and output. It can be used as a power amplifier stage or as a driver stage in high power applications.

Each device is 100% RF tested to ensure performance compliance. The part is fabricated using M/A-COM's GaAs Multifunction Self-Aligned Gate MESFET Process. M/A-COM's MSAG process features robust silicon-like manufacturing processes, planar processing of ion implanted transistors and multiple implant capability enabling power, low noise, switch and digital FET's on a single chip. The use of refractory metals and the absence of platinum in the gate metal formulation prevents hydrogen poisoning when employed in hermetic packaging.

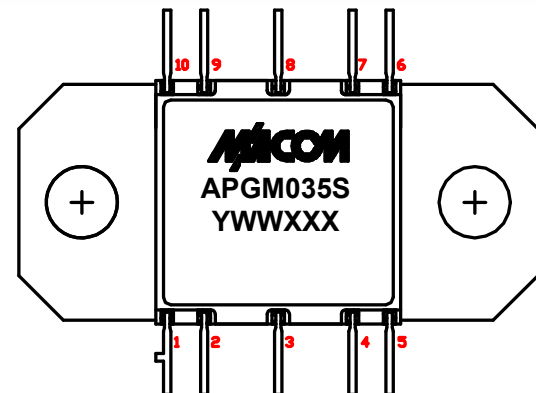

Pin Number	Description
1	No Connection
2	No Connection
3	RF IN
4	No Connection
5	No Connection
6	V _{GG}
7	No Connection
8	RF OUT
9	No Connection
10	V _{DD}

Maximum Operating Conditions ¹

Parameter	Symbol	Absolute Maximum	Units
Input Power	P _{IN}	25.0	dBm
Drain Supply Voltage	V _{DD}	+12.0	V
Gate Supply Voltage	V _{GG}	-8V min. / -3V max.	V
Quiescent Drain Current (No RF)	I _{DQ}	790	mA
Quiescent DC Power Dissipated (No RF)	P _{DISS}	6.3	W
Junction Temperature	T _J	180	°C
Storage Temperature	T _{STG}	-55 to +150	°C

1. Operation outside of these ranges may reduce product reliability.

1

M/A-COM Inc. and its affiliates reserve the right to make changes to the product(s) or information contained herein without notice. M/A-COM makes no warranty, representation or guarantee regarding the suitability of its products for any particular purpose, nor does M/A-COM assume any liability whatsoever arising out of the use or application of any product(s) or information.

• **North America** Tel: 800.366.2266 / Fax: 978.366.2266
 • **Europe** Tel: 44.1908.574.200 / Fax: 44.1908.574.300
 • **Asia/Pacific** Tel: 81.44.844.8296 / Fax: 81.44.844.8298

Visit www.macom.com for additional data sheets and product information.

2.5-5.5 GHz 1.6W Power Amplifier

MAAPGM0035S

RO-P-DS-3088 B

Recommended Operating Conditions

Characteristic	Symbol	Min	Typ	Max	Unit
Drain Supply Voltage	V _{DD}	4.0	8.0	10.0	V
Gate Supply Voltage	V _{GG}	-5.25	-5.0	-4.75	V
Input Power	P _{IN}		20.0	23.0	dBm
Junction Temperature	T _J			150	°C
Thermal Resistance	Θ _{JC}		14.9		°C/W
Package Base Temperature	T _B			Note 2	°C

2. Maximum Package Base Temperature = 150°C — Θ_{JC}* V_{DD} * I_{DQ}

Electrical Characteristics: T_B = 40°C, Z₀ = 50 Ω, V_{DD} = 8V, V_{GG} = -5V, P_{in} = 16 dBm.

Parameter	Symbol	Minimum	Typical*	Maximum	Units
Bandwidth	f	—	2.5-5.5	—	GHz
Output Power	POUT	32	33	—	dBm
Output Power @ 4 GHz	POUT	32.5	33.5	35*	dBm
Power Added Efficiency	PAE	—	32	—	%
1-dB Compression Point	P1dB	—	32	—	dBm
Small Signal Gain	G	15	18	—	dB
Small Signal Gain @ 4 GHz	G	18.5	20.5	22.5*	dB
Input VSWR	VSWR	—	1.5	2.1	—
Input VSWR @ 4 GHz	VSWR	1.2*	1.6	2.1	—
Output VSWR	VSWR	—	3:1	—	—
Gate Supply Current	I _{GG}	5	10	12	mA
Gate Supply Current @ 4 GHz	I _{GG}	5	10	12	mA
Quiescent Drain Current	I _{DQ}	0.4	0.7	0.9	A
Drain Supply Current	I _{DD}	—	0.9	1.1	A
Drain Supply Current @ 4 GHz	I _{DD}	0.7*	0.9	1.1	A
Noise Figure	NF	—	7	—	dB
2 nd Harmonic	2f	—	-10	—	dBc
3 rd Harmonic	3f	—	-20	—	dBc
Output Third Order Intercept	OTOI	—	42	—	dBm
3 rd Order Intermodulation Distortion, Single Carrier Level = 22 dBm	IM3	—	-16	—	dBm
5 th Order Intermodulation Distortion, Single Carrier Level = 22 dBm	IM5	—	-47	—	dBm

3. T_B = Package Base Temperature. 4. *Not screened-shown to indicate range of expected values



Operating Instructions

This device is static sensitive. Please handle with care. To operate the device, follow these steps.

1. Apply V_{GG} = -5.0 V, V_{DD} = 0 V.
2. Ramp V_{DD} to desired voltage, of 8V.
3. Set RF input.
4. Power down sequence in reverse. Turn V_{GG} off last.

2.5-5.5 GHz 1.6W Power Amplifier

MAAPGM0035S
RO-P-DS-3088 B

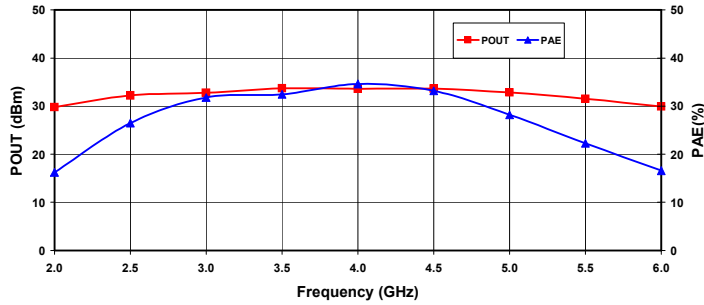

Figure 1. Output Power and Power Added Efficiency vs. Frequency at $V_{DD} = 8V$ and $P_{in} = 16\text{ dBm}$

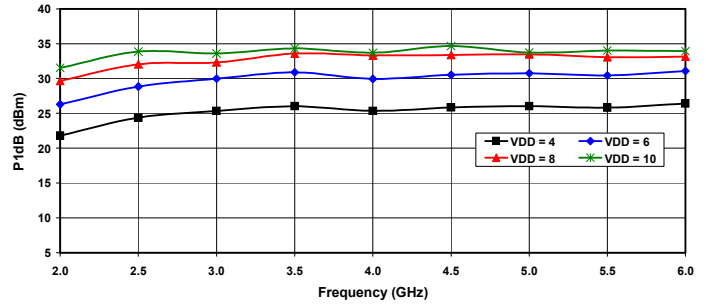

Figure 2. 1dB Compression Point vs. Drain Voltage

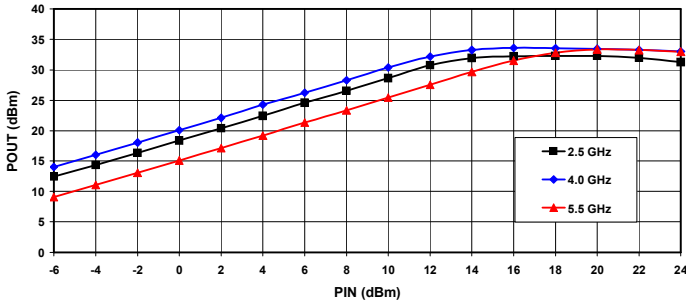

Figure 3. Output Power vs. Input Power at $V_{DD} = 8V$

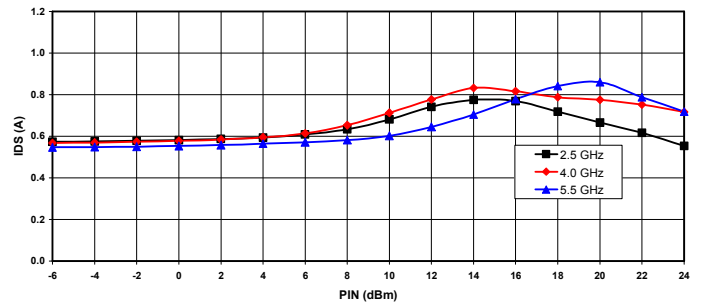

Figure 4. Drain Current vs. Input Power at $V_{DD} = 8V$

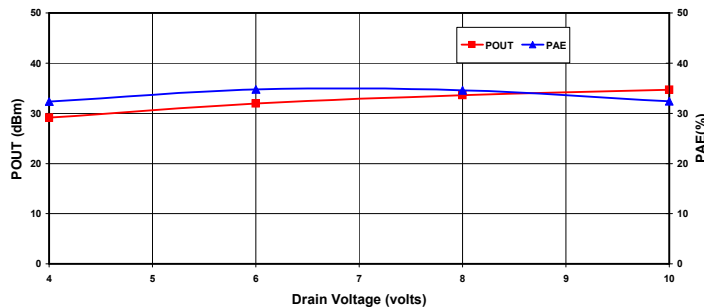

Figure 5. Saturated Output Power and Power Added Efficiency vs. Drain Voltage at $f_0 = 4\text{ GHz}$

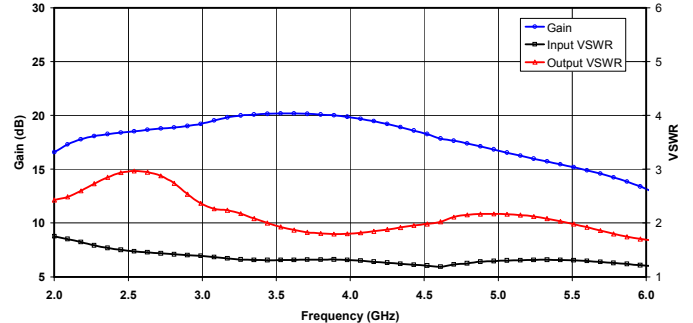

Figure 6. Small Signal Gain and VSWR vs. Frequency at $V_{DD} = 8V$.

2.5-5.5 GHz 1.6W Power Amplifier

MAAPGM0035S

RO-P-DS-3088 B

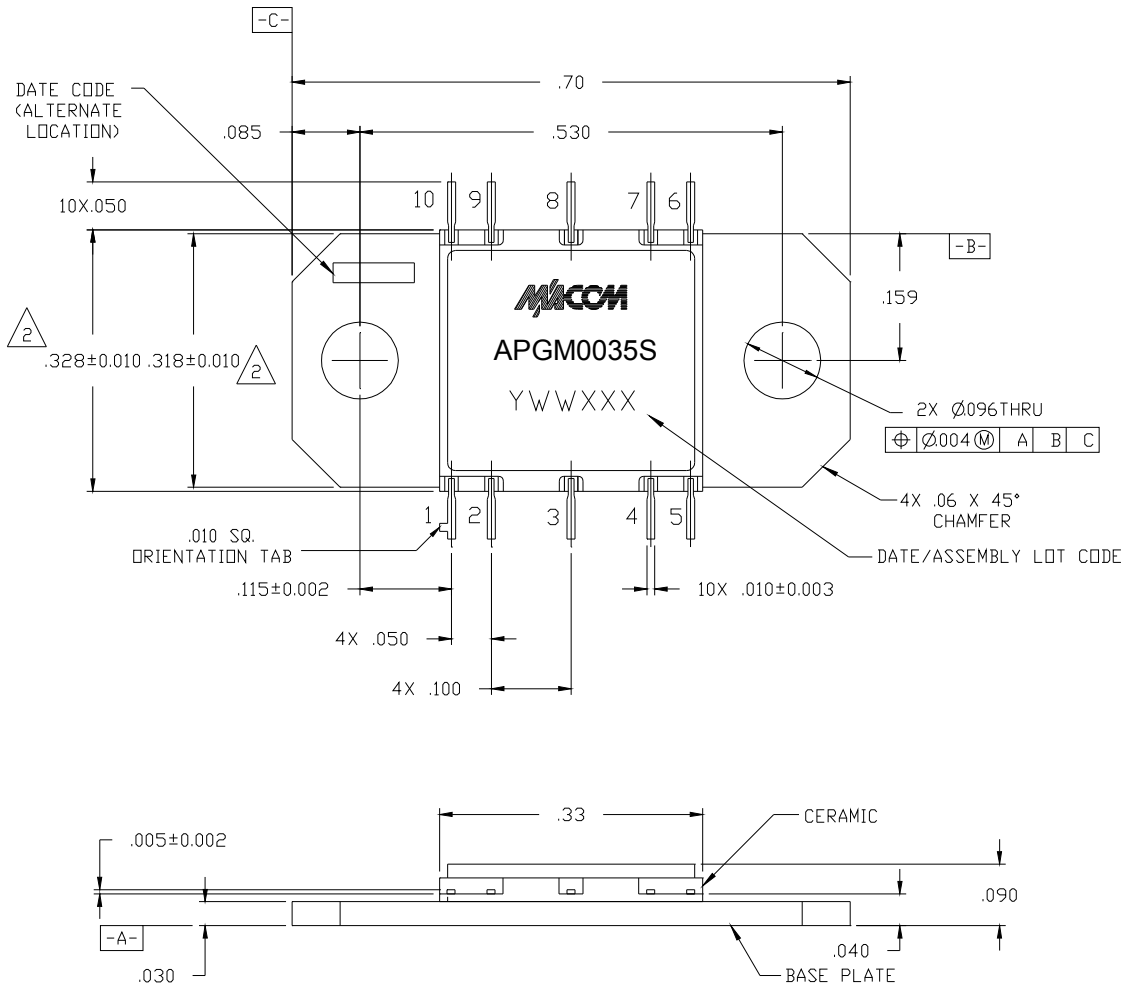
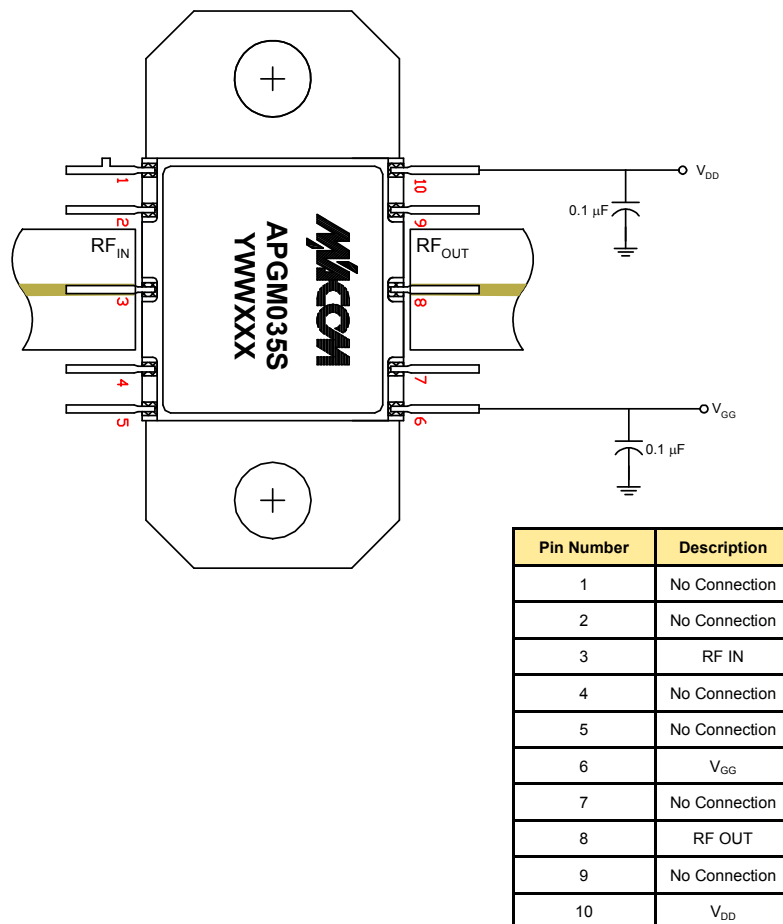

Figure 5. CR-15 Package Dimensions

The CR-15 is a high frequency, low thermal resistance package. The package consists of a cofired ceramic construction with a copper-tungsten base and iron-nickel-cobalt leads. The finish consists of electrolytic gold over nickel plate.

Figure 6. Recommended Bias Configuration



Assembly Instructions:

This flange mount style package provides a robust interface between a highly integrated GaAs MMIC device and a circuit board which may be assembled using conventional surface mount techniques. A thin shim made of a thermally and electrically conductive, ductile material should be used prior to installation of the CR-15 to improve the thermal and electrical performance of the package to housing interface. Refer to **M/A-COM Application Note #M567*** for more information .

For applications where surface mount components are to be installed after the CR-15 installation, this package will not be damaged when subjected to typical convection or IR oven reflow profiles. Refer to **M/A-COM Application Note #M538*** for maximum allowable reflow time and temperature. Alternatively, the package leads may be individually soldered. Whether an iron or hot gas soldering equipment is used, care should be taken to insure that the temperature is well controlled and electric static discharge (ESD) safe.

Biasing Note: Must apply negative bias to V_{GG} before applying positive bias to V_{DD} to prevent damage to amplifier.

* Application Notes can be found by going to the Site Search Page on M/A-COM's web page (<http://www.macom.com/search/search.jsp>) and searching for the required Application Note.