

**Voltage Variable Absorptive Attenuator
12 dB, DC-2.0 GHz**

**MAAV-007941
V1**

Features

- 12 dB Voltage Variable Attenuation
- Low Intermodulation Products
- Low DC Power Consumption: 50 μ W
- Single Voltage Control: 0 to -4 Volts
- Nanosecond Switching Speed
- Temperature Range: -40°C to +85°C
- Lead-Free SOIC-8 Plastic Package
- 100% Matte Tin Plating over Copper
- Halogen-Free "Green" Mold Compound
- 260°C Reflow Compatible
- RoHS* Compliant Version of AT-250

Description

M/A-COM's MAAV-007941 is a GaAs MMIC voltage variable absorptive attenuator in a low cost lead-free SOIC 8-lead surface mount plastic package. The MAAV-007941 is ideally suited for use where attenuation fine tuning, fast switching and very low power consumption are required.

Typical applications include radio, cellular, GPS equipment and other automatic gain/level control circuits.

The MAAV-007941 is fabricated with a monolithic GaAs MMIC using a mature 1-micron process. The process features full chip passivation for increased performance and reliability.

Functional Schematic

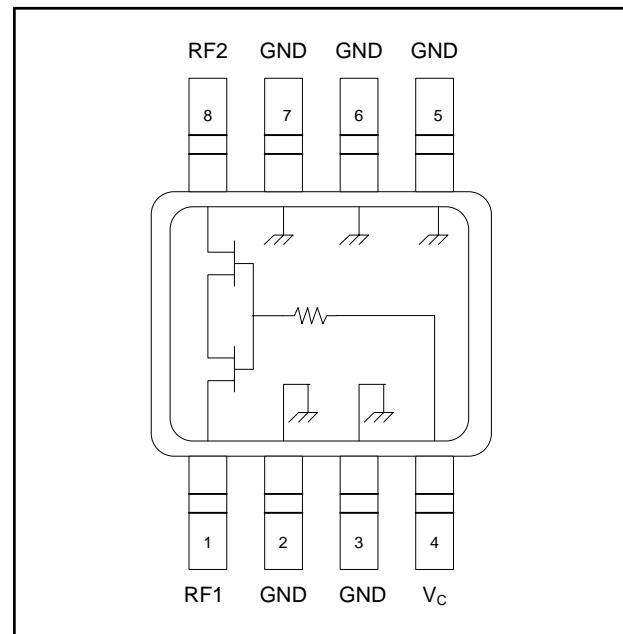

Pin Configuration

Pin No.	Function	Pin No.	Function
1	RF1	5	Ground
2	Ground	6	Ground
3	Ground	7	Ground
4	V _c	8	RF2

Ordering Information ¹

Part Number	Package
MAAV-007941-000000	Bulk Packaging
MAAV-007941-TR3000	3000 piece reel

1. Reference Application Note M513 for reel size information.

Absolute Maximum Ratings ²

Parameter	Absolute Maximum
Input Power	+21 dBm
Control Voltage	+5V, -8.5V
Operating Temperature	-40°C to +85°C
Storing Temperature	-65°C to +150°C

2. Exceeding any one or combination of these limits may cause permanent damage to this device.

* Restrictions on Hazardous Substances, European Directive 2002/95/EC.

**Voltage Variable Absorptive Attenuator
12 dB, DC-2.0 GHz**

**MAAV-007941
V1**

Electrical Specifications: $T_A = 25^\circ\text{C}$, $Z_0 = 50 \Omega$

Parameter	Test Conditions ³	Units	Min.	Typ.	Max.
Insertion Loss	DC - 0.1 GHz	dB	—	2.9	3.1
	DC - 0.5 GHz	dB	—	3.0	3.2
	DC - 1.0 GHz	dB	—	3.2	3.5
	DC - 2.0 GHz	dB	—	3.4	3.8
Flatness (Peak to Peak)	DC - 0.1 GHz	dB	—	± 0.1	± 0.3
	DC - 0.5 GHz	dB	—	± 0.2	± 0.4
	DC - 1.0 GHz	dB	—	± 0.5	± 0.8
	DC - 2.0 GHz	dB	—	± 1.2	± 1.5
VSWR		Ratio	—	2.1:1	—
Trise, Tfall	10% to 90% RF, 90% to 10% RF	nS	—	3	—
Ton, Toff	50% Control to 90% RF, 50% Control to 10% RF	nS	—	5	—
Transients	In Band	mV	—	10	—
Power Handling	Linear Operation	dBm	—	13	—
	Absolute Maximum Input Power	dBm	—	21	—
IP ₂	0.05 GHz	dBm	28	34	—
	0.5 - 2.0 GHz Measured Relative to Input Power (For two-tone Input Power Up to +5 dBm)	dBm	40	47	—
IP ₃ ⁴	0.05 GHz	dBm	18	31	—
	0.5 - 2.0 GHz Measured Relative to Input Power (For two-tone Input Power Up to +5 dBm)	dBm	18.5	36	—

3. Control voltage: 0 to -4 volts @ 20 μA typical.

4. Typical readings are for levels above 6 dB attenuation. For levels below 6 dB, the minimum specification numbers apply.

Lead-Free SOIC-8[†]

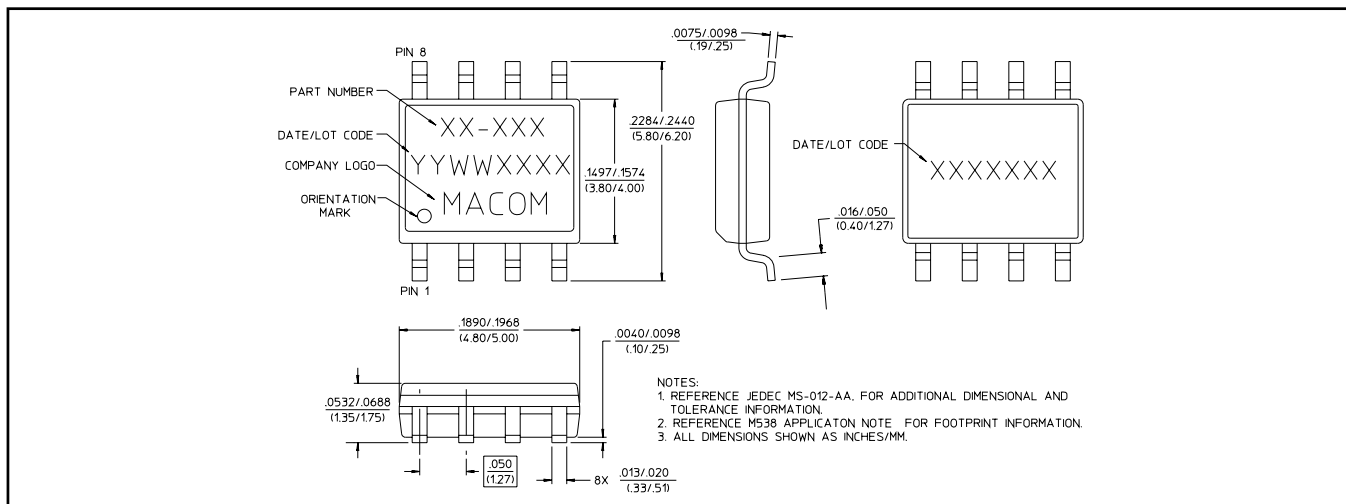

[†] Reference Application Note M538 for lead-free solder reflow recommendations.
Meets JEDEC moisture sensitivity level 1 requirements.

2

M/A-COM Inc. and its affiliates reserve the right to make changes to the product(s) or information contained herein without notice. M/A-COM makes no warranty, representation or guarantee regarding the suitability of its products for any particular purpose, nor does M/A-COM assume any liability whatsoever arising out of the use or application of any product(s) or information.

- **North America** Tel: 800.366.2266 / Fax: 978.366.2266
- **Europe** Tel: 44.1908.574.200 / Fax: 44.1908.574.300
- **Asia/Pacific** Tel: 81.44.844.8296 / Fax: 81.44.844.8298

Visit www.macom.com for additional data sheets and product information.

Typical Performance Curves

Insertion Loss vs. Frequency

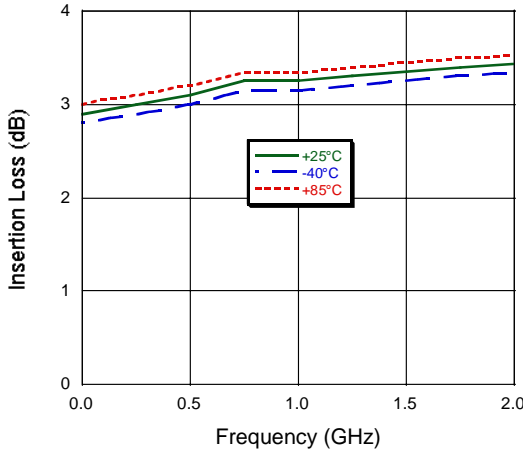

Attenuation vs. Frequency

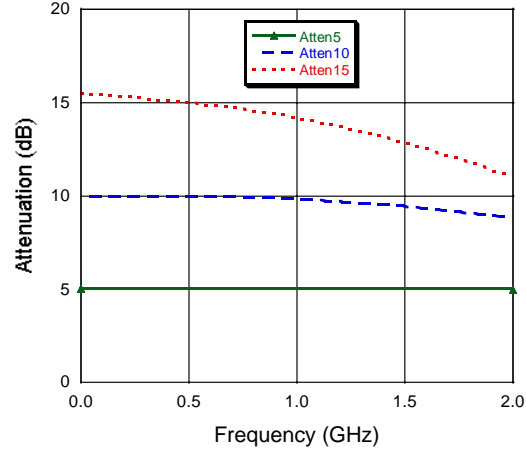

VSWR vs. Frequency

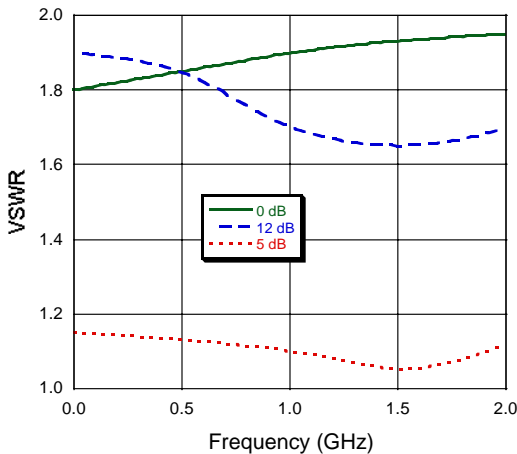

Attenuation vs. Control Voltage, F = 950 MHz

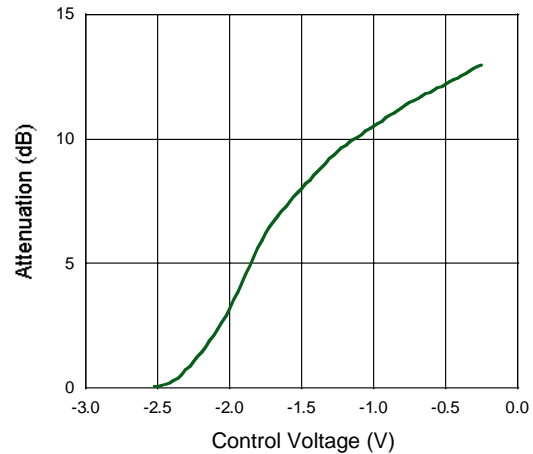

Phase vs. Control Voltage, F = 950 MHz

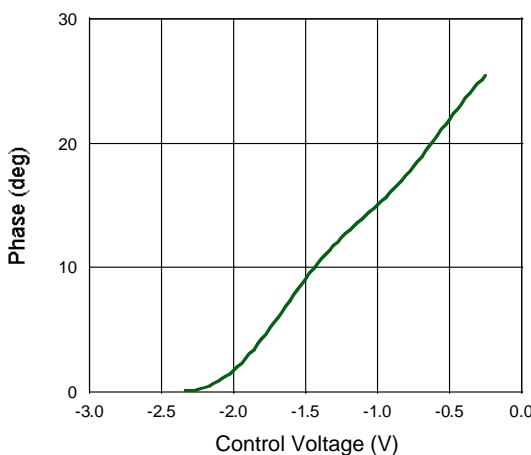

Handling Procedures

Please observe the following precautions to avoid damage:

Static Sensitivity

Gallium Arsenide Integrated Circuits are sensitive to electrostatic discharge (ESD) and can be damaged by static electricity. Proper ESD control techniques should be used when handling these devices.