

ELECTRICAL SPECIFICATIONS:

- | | | |
|-----|--|----------------------------|
| 1.0 | URNS RATIO: (P6-P7-P8) : (J6-J3) | : 1CT : 1 ±3% |
| | (P2-P3-P1) : (J2-J1) | : 1CT : 2 ±3% |
| 2.0 | INDUCTANCE: (P6-P8)=(J6-J3) | : 98uH MIN. @ 0.01V, 10KHz |
| | (P3-P1) | : 18uH MIN. @ 0.01V, 10KHz |
| 3.0 | LEAKAGE INDUCTANCE: P6-P8 (WITH J6 AND J3 SHORT) | : 0.3uH MAX. @ 1MHz |
| | P3-P1 (WITH J2 AND J1 SHORT) | : 0.08uH MAX. @ 1MHz |
| 4.0 | INTERWINDING CAPACITANCE: (P6,P8) TO (J6,J3) | : 8pf MAX @ 1MHz |
| | (P3,P1) TO (J2,J1) | : 6pf MAX. @ 1MHz |
| 5.0 | DC RESISTANCE: (J6-J3)=(J2-J1) | : 0.7 ohms Max. |
| | (P6-P7)=(P7-P8) | : 0.3 ohms Max. |
| | (P2-P1)=(P2-P3) | : 0.3 ohms Max. |
| 6.0 | DIELECTRIC WITHSTAND: (P6,P8) TO (J6,J3) | : 1500VAC |
| | (P3,P1) TO (J2,J1) | : 1500VAC |

 Stewart Connector	InNet Technologies, Inc. http://www.innet-tech.com
	Stewart Connector Systems http://www.stewartconnector.com
SHEET 1 OF 3	DRAWING NO. SI-70012 REV. X3

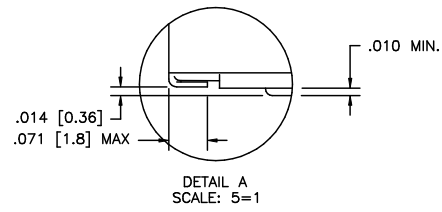
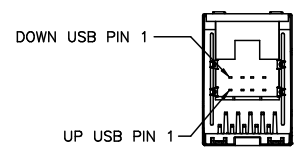
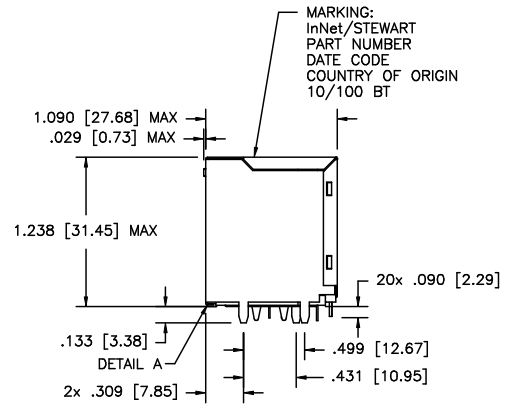
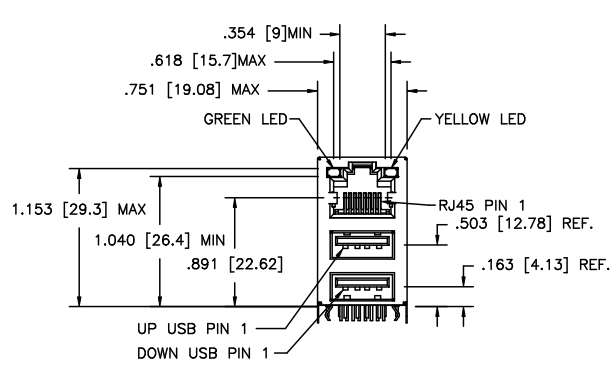

NOTES:

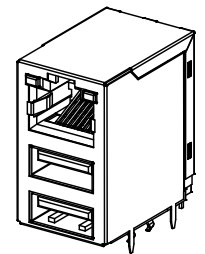

- 1.0 TOLERANCE COMPLY WITH FCC DIMENSION REQUIREMENTS.
- 2.0 PIN NOT ELECTRICALLY CONNECTED MAY BE OMITTED. SEE ELECTRICAL DRAWING FOR OMITTED PINS.
- 3.0 MATERIAL:
 PLASTIC: UL94V-0
 TERMINAL USB: CERTIFIED TO USB SPEC 2.0
 TERMINAL RJ45: 50 MICROINCHES Au OVER 50 MICROINCHES Ni OVER PHOSBRONZE SHIELD, BOTH USB AND RJ45: BRASS PLATED W/EITHER Ni OR TIN-LEAD
- 4.0 GENERAL TOLERANCE: ±.005 [.127]
- 5.0 INSERTION FORCE RJ45: 9.0 lbs MAX
 INSERTION FORCE USB: 7.7 lbs MAX
- 6.0 WITHDRAW FORCE RJ45: 2.9 lbs MIN
 WITHDRAW FORCE USB: 2.2 lbs MIN
- 7.0 DURABILITY FORCE RJ45: 1000 INSERTIONS
 DURABILITY FORCE USB: 1500 INSERTIONS
- 8.0 CONNECTOR TO PCB INSERTION FORCE: 8.6 lbs MAX
- 9.0 SEE SPECIAL MARKING "10/100 BT"

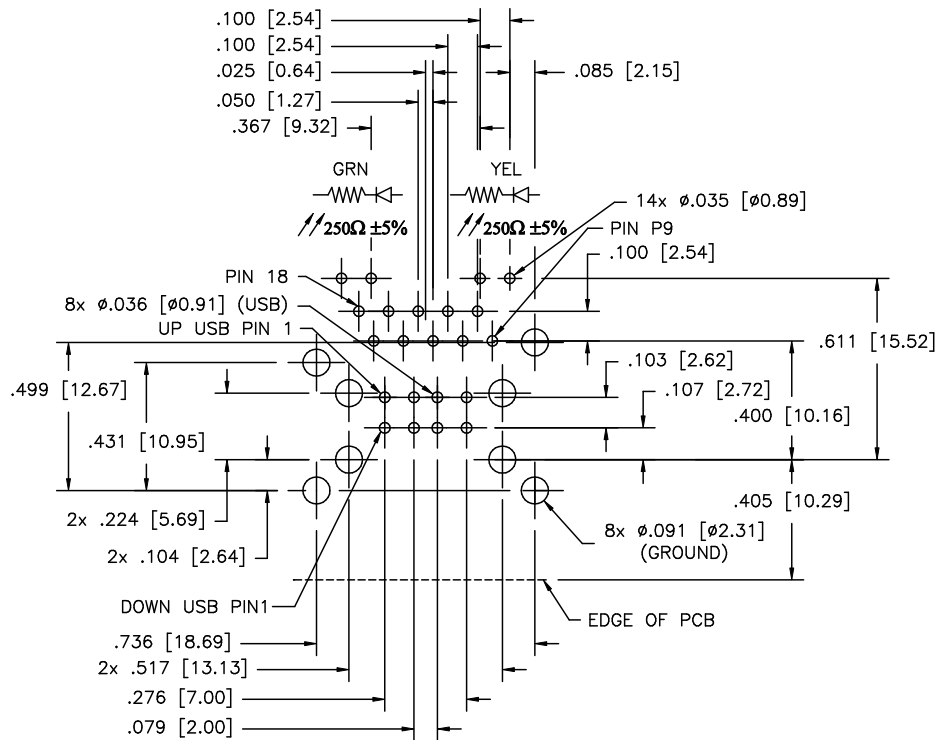

	InNet Technologies, Inc. http://www.innet-tech.com	
	Stewart Connector Systems http://www.stewartconnector.com	
SHEET 2 OF 3	DRAWING NO. SI-70012	REV X5



PC BOARD LAYOUT COMPONENT SIDE SHOWN
 TOLERANCE: ±.003 [.08] UNLESS OTHERWISE SPECIFIED

 InNet Technologies, Inc. http://www.innet-tech.com	
 Stewart Connector Systems http://www.stewartconnector.com	
SHEET 3 OF 3	DRAWING NO. SI-70012 REV X5