

## 1. Features

- Low EMI noise and small footprint using inductor-imbedded ferrite substrate
- High efficiency using synchronous rectifier technology and PFM/PWM auto-select function
- Input voltage range : 2.3~5.5V
- Maximum Load Current: 600mA (depends on output voltage)
- Fixed output voltage: 0.8V – 4V
- Switching frequency : 3.0MHz

## 2. Mechanical details

### 2-1 Outline

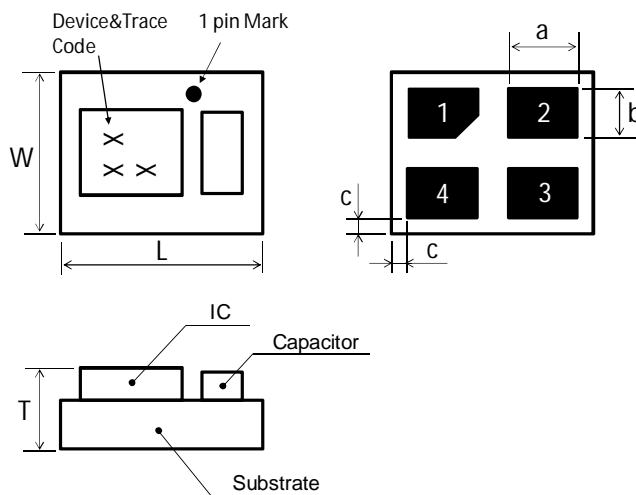

Unit: mm

Mark	Dimension
L	2.5 +/- 0.2
W	2.0 +/- 0.2
T	1.1 MAX
a	0.85 +/- 0.1
b	0.60 +/- 0.1
c	0.15 +/- 0.15

### 2-2. Pin configuration

Pin	Symbol	I/O	Description
1	Vin	Input	Voltage input pin
2	EN	Input	ON/OFF control pin H: Enable, L: Disable
3	Vout	Output	Voltage output pin
4	GND	-	GND pin

### 3. Ordering Information

Part number	Output Voltage	Device Specific Feature	MOQ
LXDC2HL10A-080	1.0V		T/R, 3000pcs/R
LXDC2HL12A-050	1.2V		T/R, 3000pcs/R
LXDC2HL1DA-087	1.35V		T/R, 3000pcs/R
LXDC2HL15A-051	1.5V		T/R, 3000pcs/R
LXDC2HL18A-052	1.8V		T/R, 3000pcs/R
LXDC2HL25A-053	2.5V		T/R, 3000pcs/R
LXDC2HL30A-054	3.0V		T/R, 3000pcs/R
LXDC2HL33A-055	3.3V		T/R, 3000pcs/R

### 4. Electrical Specification

#### 4-1 Absolute maximum ratings

Parameter	symbol	rating	Unit
Maximum input voltage	V <sub>in</sub>	6.3	V
Operating temperature	T <sub>OP</sub>	-40 to +85	°C
Storage temperature	T <sub>STO</sub>	-40 to +85	°C

**4-2 Electrical characteristics (Ta=25°C)**

Parameter	Symbol	Condition		Min.	Typ.	Max.	Unit		
Input voltage	$V_{in}$			2.3	3.6	5.5	V		
UVLO voltage	UVLO			1.0	1.4	1.8	V		
Input leak current	lin-off	$V_{in}=3.6V$ , $EN=0V$	LXDC2HL10A-080		0	2	uA		
			LXDC2HL12A-050						
			LXDC2HL1DA-087						
			LXDC2HL15A-051						
			LXDC2HL18A-052						
			LXDC2HL25A-053						
		$V_{in}=5.0V$ , $EN=0V$	LXDC2HL30A-054						
			LXDC2HL33A-055						
Output voltage accuracy	Vout	$V_{in}-V_{out}>1V$	LXDC2HL10A-080	0.976	1.0	1.024	V		
			LXDC2HL12A-050	1.176	1.20	1.224			
			LXDC2HL1DA-087	1.323	1.35	1.377			
			LXDC2HL15A-051	1.47	1.50	1.53			
			LXDC2HL18A-052	1.764	1.80	1.836			
			LXDC2HL25A-053	2.45	2.50	2.55			
		$V_{in}-V_{out}>0.7V$	LXDC2HL30A-054	2.94	3.00	3.06			
$V_{in}-V_{out}>0.5V$	LXDC2HL33A-055	3.234	3.30	3.366					
Load current range	Iout	LXDC2HL10A-080		0		600	mA		
		LXDC2HL12A-050							
		LXDC2HL1DA-087							
		LXDC2HL15A-051							
		LXDC2HL18A-052							
		LXDC2HL25A-053						0	500
		LXDC2HL30A-054						0	400
		LXDC2HL33A-055						0	300
Ripple voltage	Vrpl	$V_{in}=3.6V$ , $I_{out}=300mA$ , $BW=100MHz$	LXDC2HL10A-080		15	30	mV		
			LXDC2HL12A-050						
			LXDC2HL1DA-087						
			LXDC2HL15A-051						
			LXDC2HL18A-052						
			LXDC2HL25A-053						
		$V_{in}=5V$ , $I_{out}=300mA$ , $BW=100MHz$	LXDC2HL30A-054						
			LXDC2HL33A-055						

Parameter	Symbol	Condition	Min.	Typ.	Max.	Unit	
Efficiency	EFF	Vin=3.6V, Iout=150mA	LXDC2HL10A-080	73	78		%
			LXDC2HL12A-050	75	80		
			LXDC2HL1DA-087	77	82		
			LXDC2HL15A-051	81	85		
			LXDC2HL18A-052	81	85		
			LXDC2HL25A-053	84	88		
		Vin=5V, Iout=150mA	LXDC2HL30A-054	83	87		
			LXDC2HL33A-055	84	88		
EN control voltage	VENH	ON ; Enable	1.4		Vin	V	
	VENL	OFF ; Disable	0		0.25	V	
SW Frequency	fosc		2.5	3.0	3.5	MHz	
Over current protection	OCP	LXDC2HL10A-080	600	900	1200	mA	
		LXDC2HL12A-050					
		LXDC2HL1DA-087					
		LXDC2HL15A-051					
		LXDC2HL18A-052	550	900	1200		
		LXDC2HL25A-053					
		LXDC2HL30A-054					
		LXDC2HL33A-055	350	900	1200		
		If the over current event continues less than Tlatch, auto-recovery. If the over current event continues more than Tlatch, latch-up. Restart by toggling EN voltage or Vin voltage					
	Tlatch	Latch-up mask time @ Vout=0.8 × Vnom		20		Usec	
Start-up time	Ton			0.9		Msec	

\* Test condition is shown in section 6.

**5. Test Circuit**

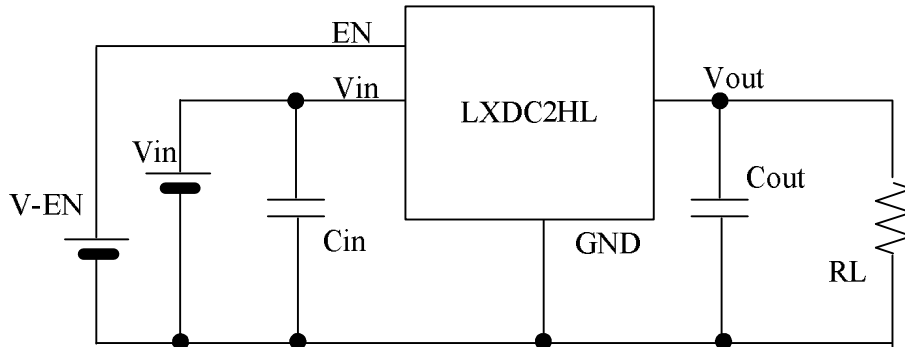

Cin : 4.7uF/6.3V (GRM188B30J475K)

Cout : 10uF/6.3V (GRM188B30J106M)

**6. Reference Land Pattern**

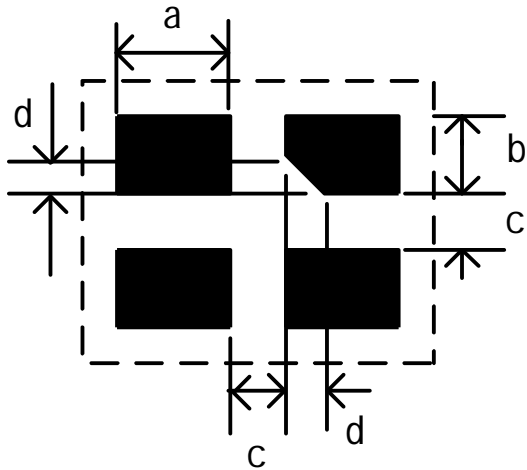

Unit: mm

Mark	Dimension
a	0.85
b	0.60
c	0.5
d	0.2

Notes: this land layout is for reference purpose only.

7. Measurement Data

**Micro DCDC Converter evaluation board (P2LX0244)**

**Measurement setup**

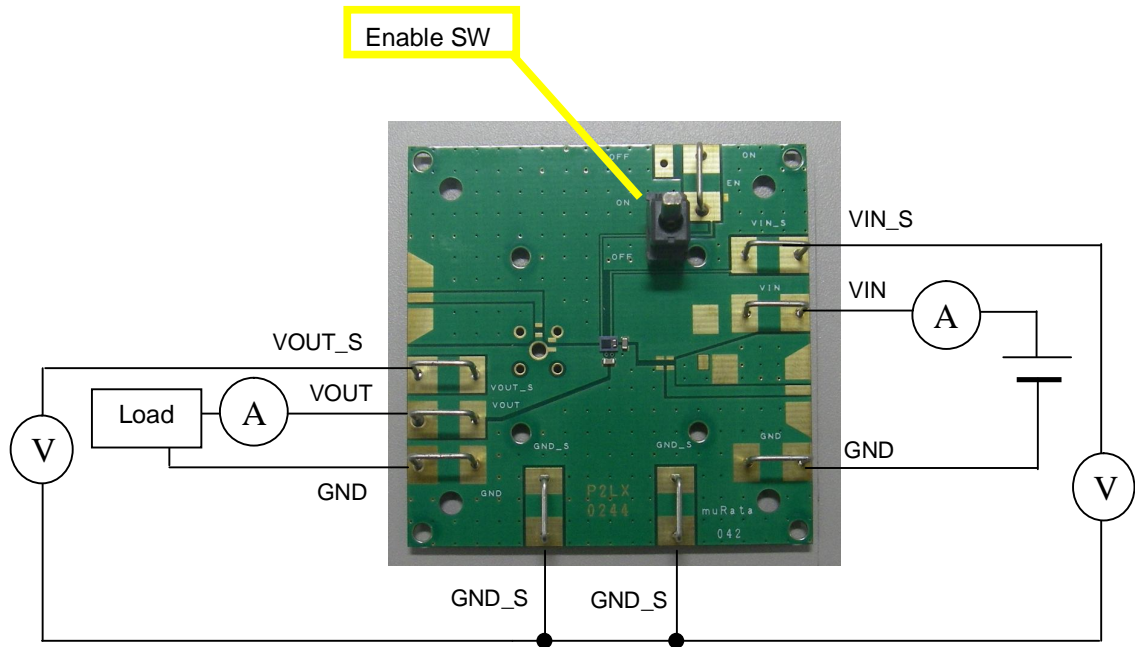

## Typical Measurement Data (reference purpose only)

### Efficiency

Vin=3.6V, Vout=1.0V

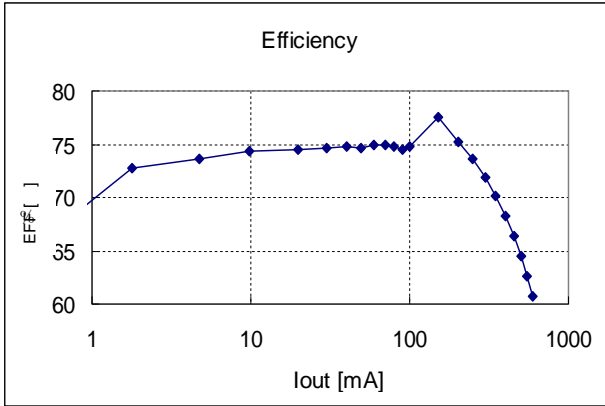

Vin=3.6V, Vout=1.2V

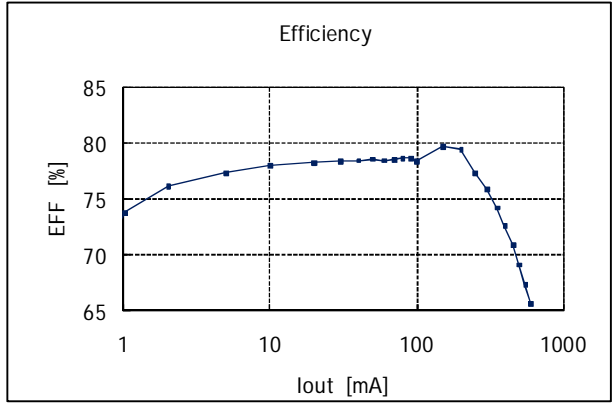

Vin=3.6V, Vout=1.35V

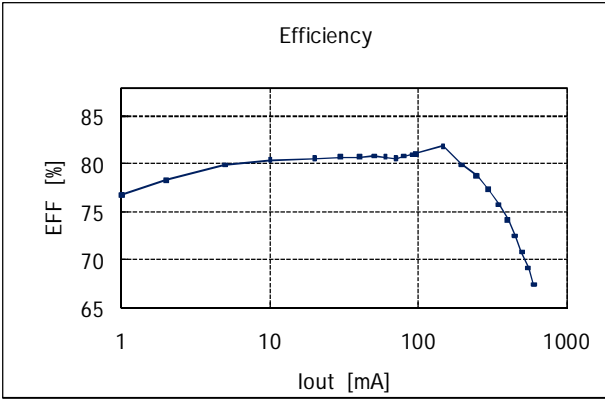

Vin=3.6V, Vout=1.5V

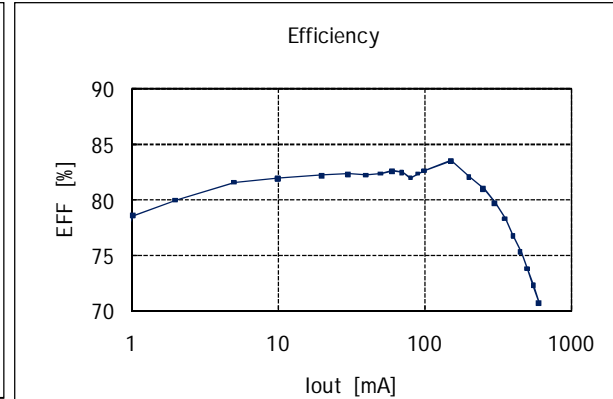

Vin=3.6V, Vout=1.8V

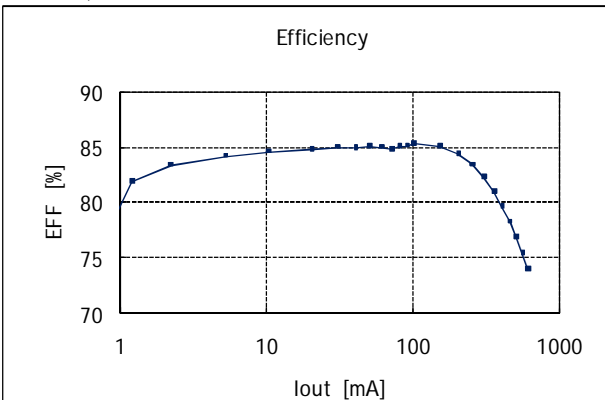

Vin=3.6V, Vout=2.5V

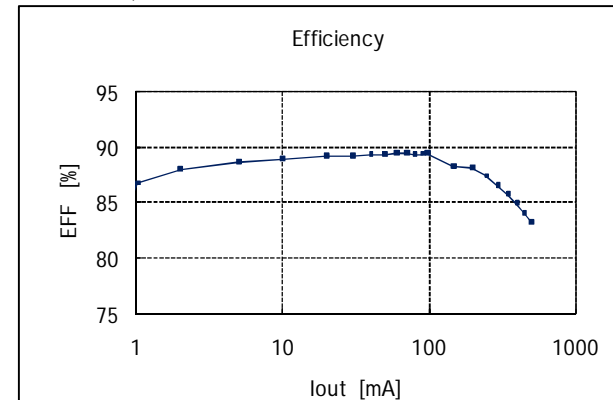

Vin=5.0V, Vout=3.0V

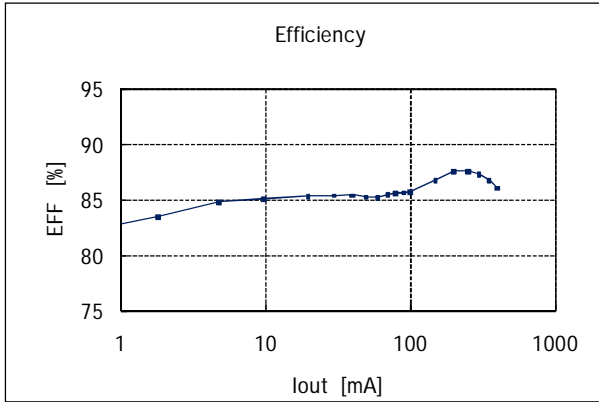

Vin=5.0V, Vout=3.3V

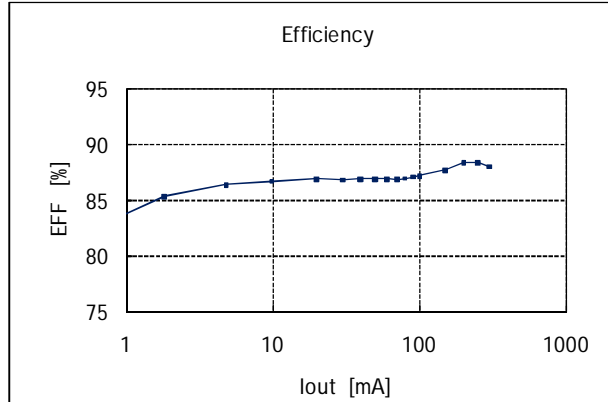



## Typical Measurement Data (reference purpose only)

### Load Regulation

Vin=3.6V, Vout=1.0V

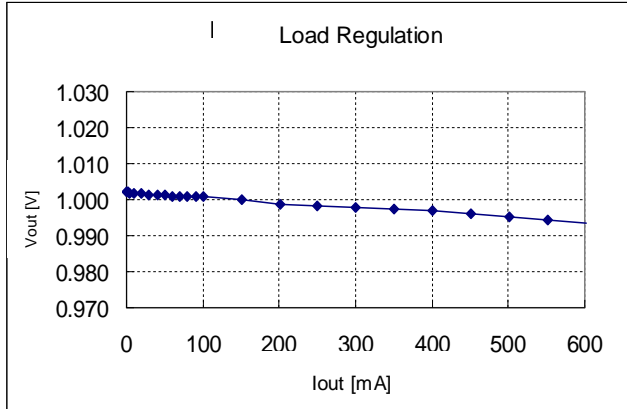

Vin=3.6V, Vout=1.2V

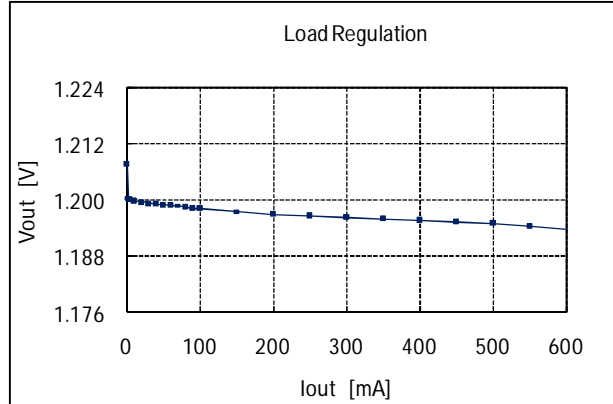

Vin=3.6V, Vout=1.35V

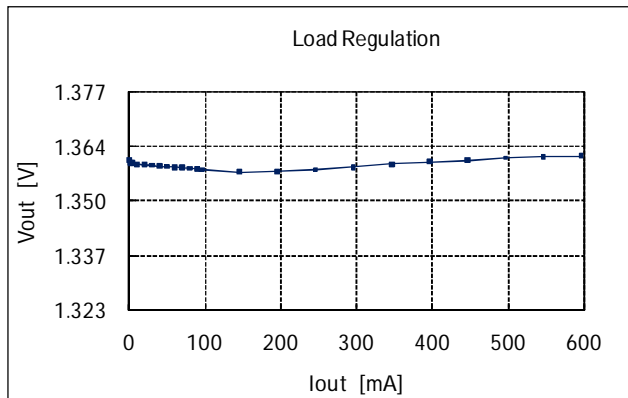

Vin=3.6V, Vout=1.5V

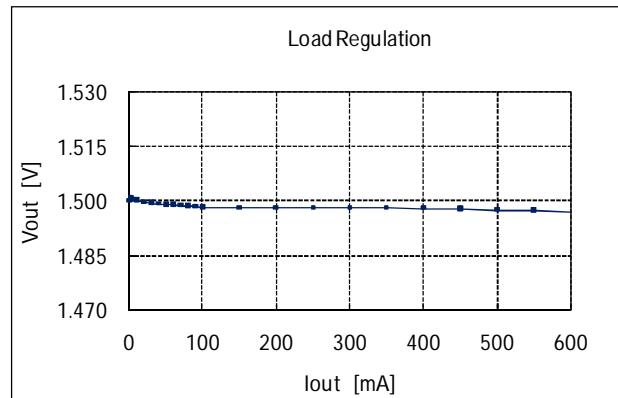

Vin=3.6V, Vout=1.8V

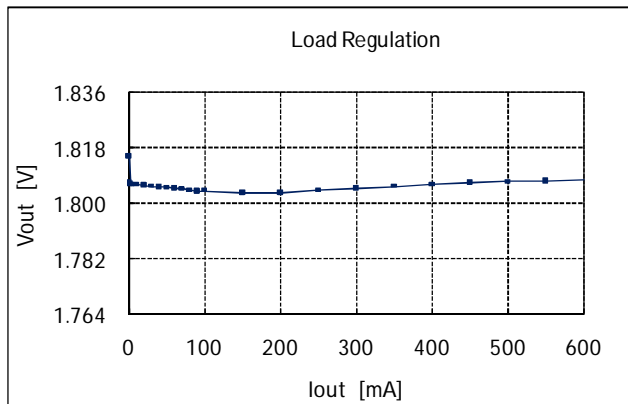

Vin=3.6V, Vout=2.5V

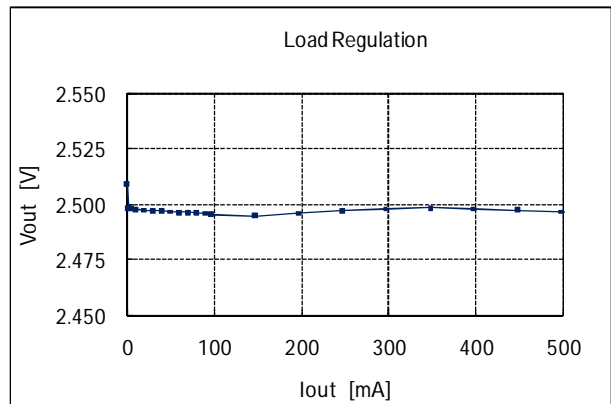

Vin=5.0V, 3.0V

Vin=5.0V, Vout=3.3V

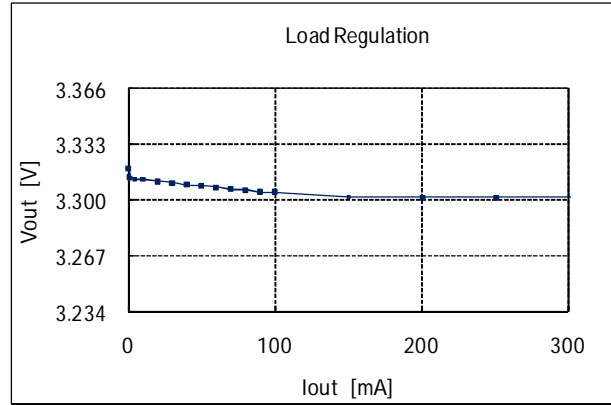
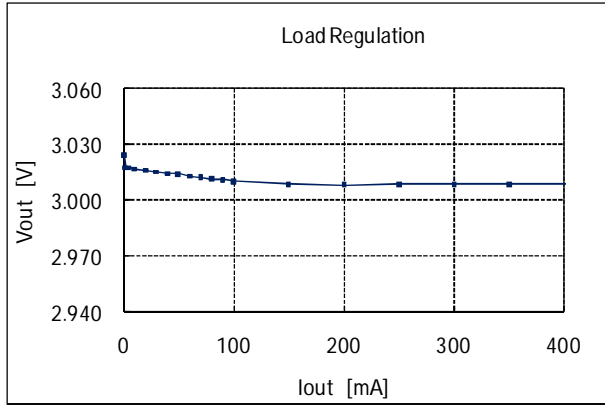

## Typical Measurement Data (reference purpose only)

### Output Ripple-Noise

Vin=3.6V, Vout=1.0V, BW : 100MHz

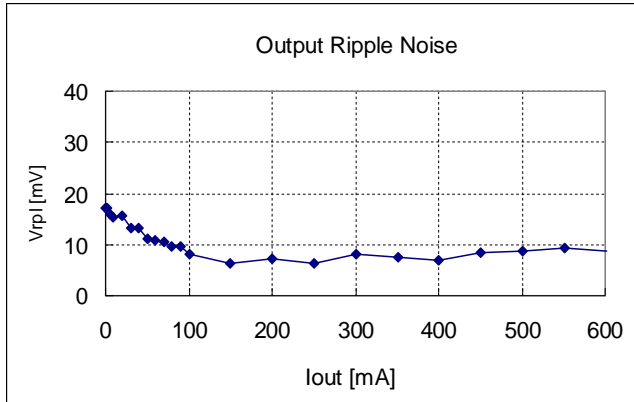

Vin=3.6V, Vout=1.2V, BW: 150MHz

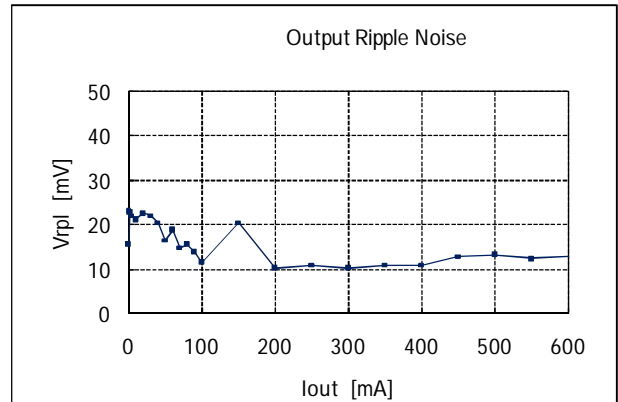

Vin=3.6V, Vout=1.35V, BW: 150MHz

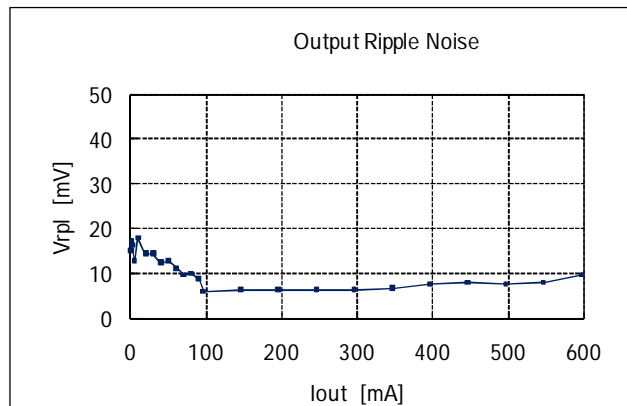

Vin=3.6V, Vout=1.5V, BW: 150MHz

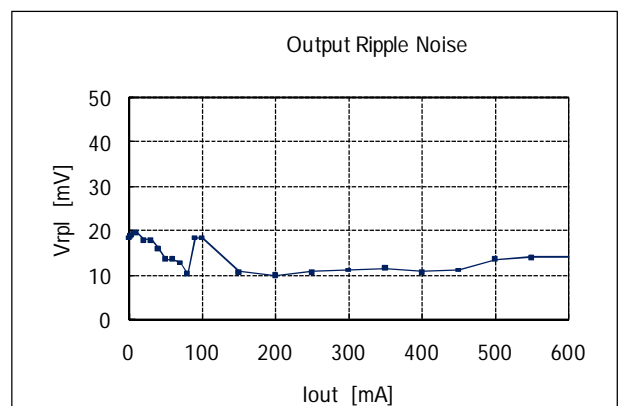

Vin=3.6V, Vout=1.8V, BW: 150MHz

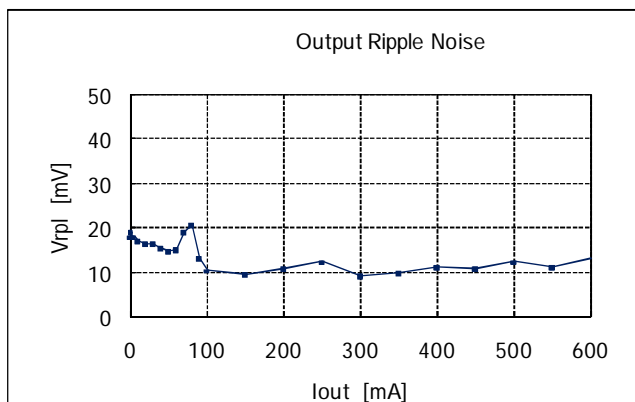

Vin=3.6V, Vout=2.5V, BW: 150MHz

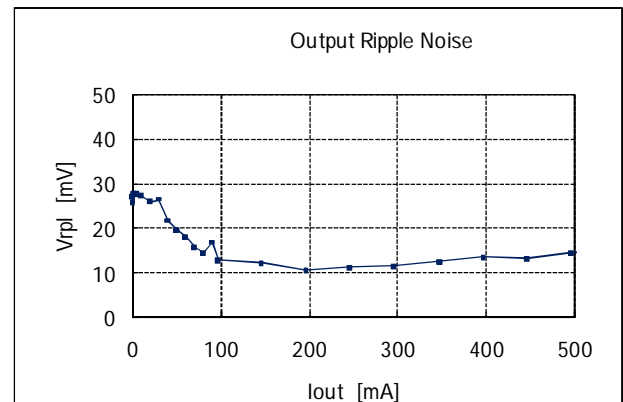

Vin=5.0V, Vout=3.0V, BW: 150MHz

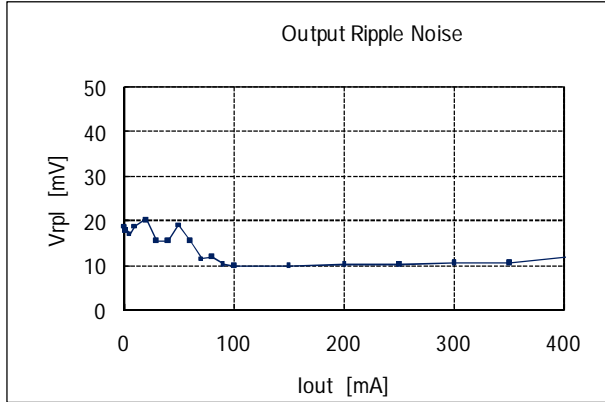

Vin=5.0V, Vout=3.3V, BW: 150MHz

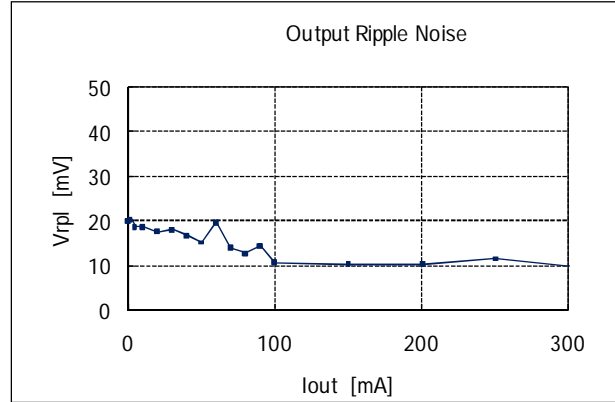

## Typical Measurement Data (reference purpose only)

### Load Transient Response

Vin=3.6V, Vout=1.0V

TBD

Vin=3.6V, Vout=1.2V

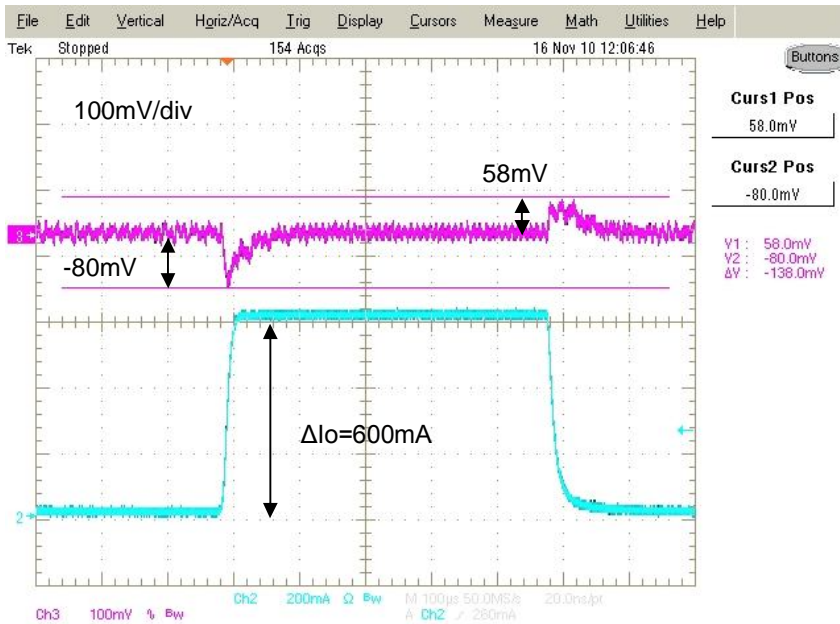

Vin=3.6V, Vout=1.35V

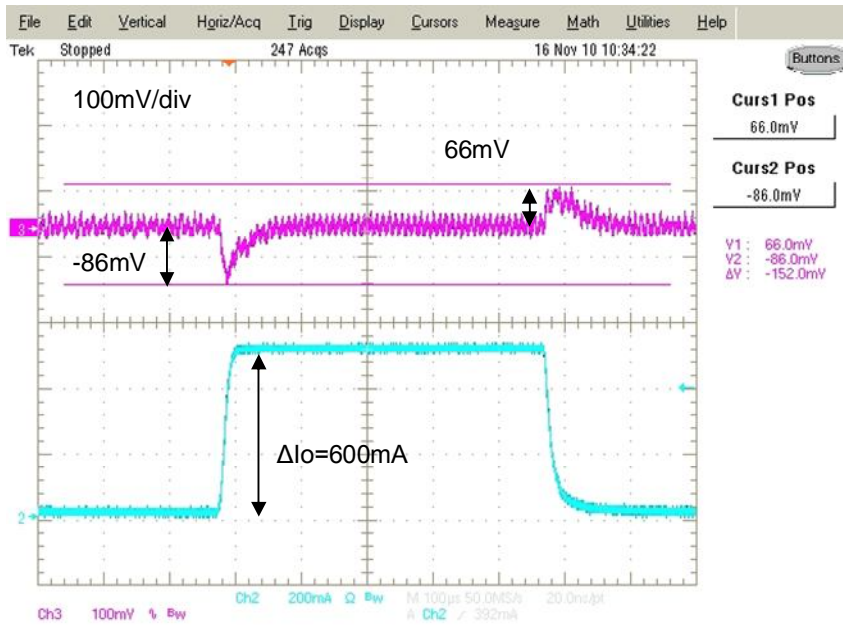

Vin=3.6V, Vout=1.8V

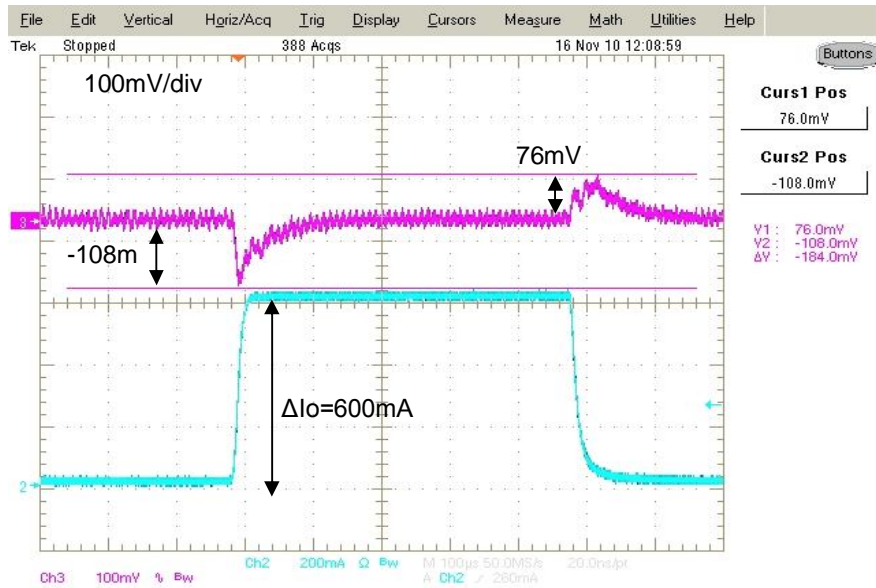

Vin=3.6V, Vout=2.5V

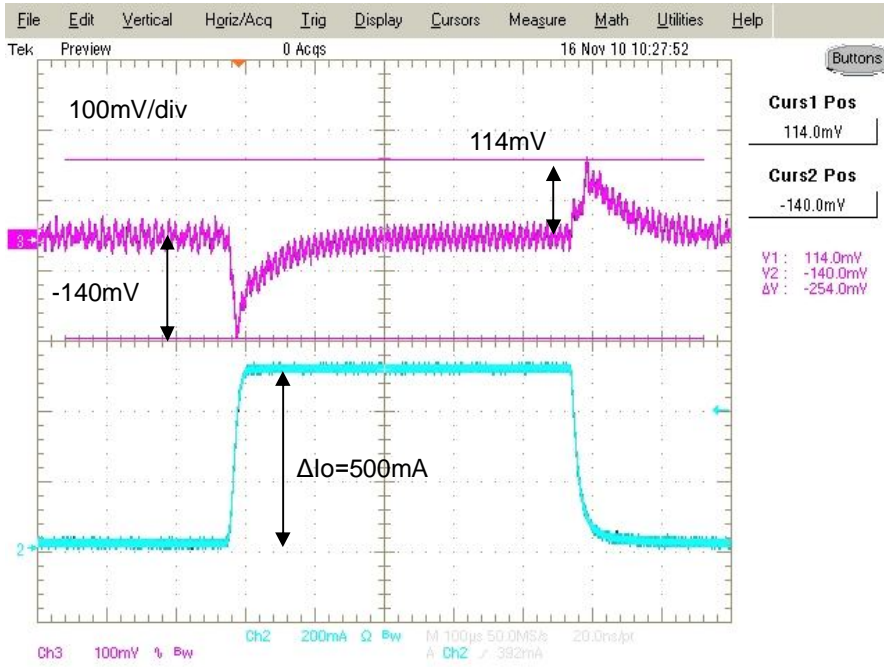

Vin=5.0V, Vout=3.0V

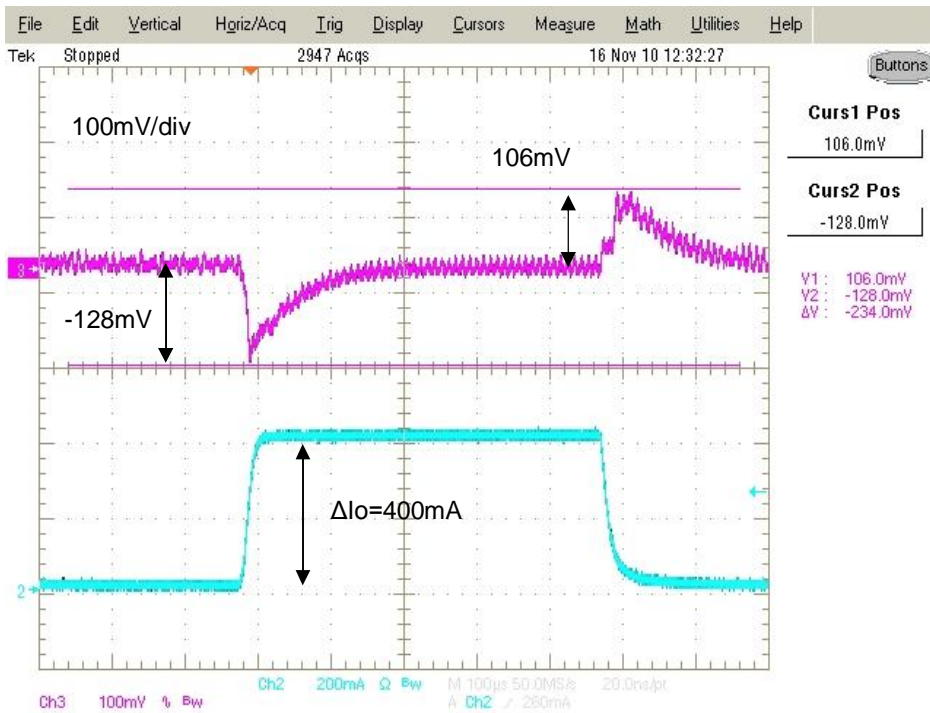

Vin=5.0V, Vout=3.3V

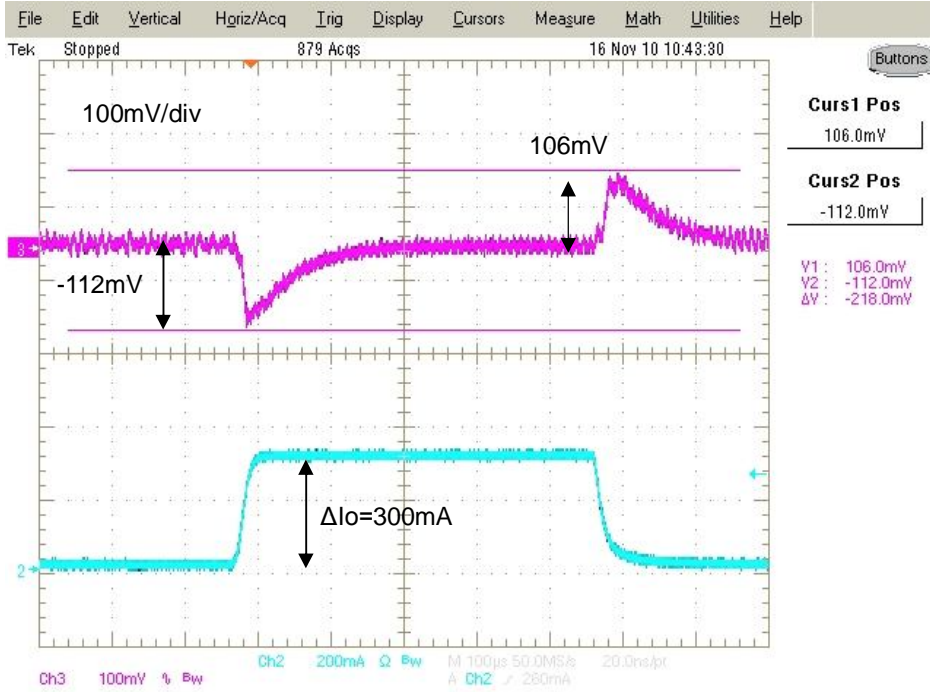



### 8. Tape and Reel Packing

#### 1) Dimensions of Tape (Plastic tape)

Unit: mm

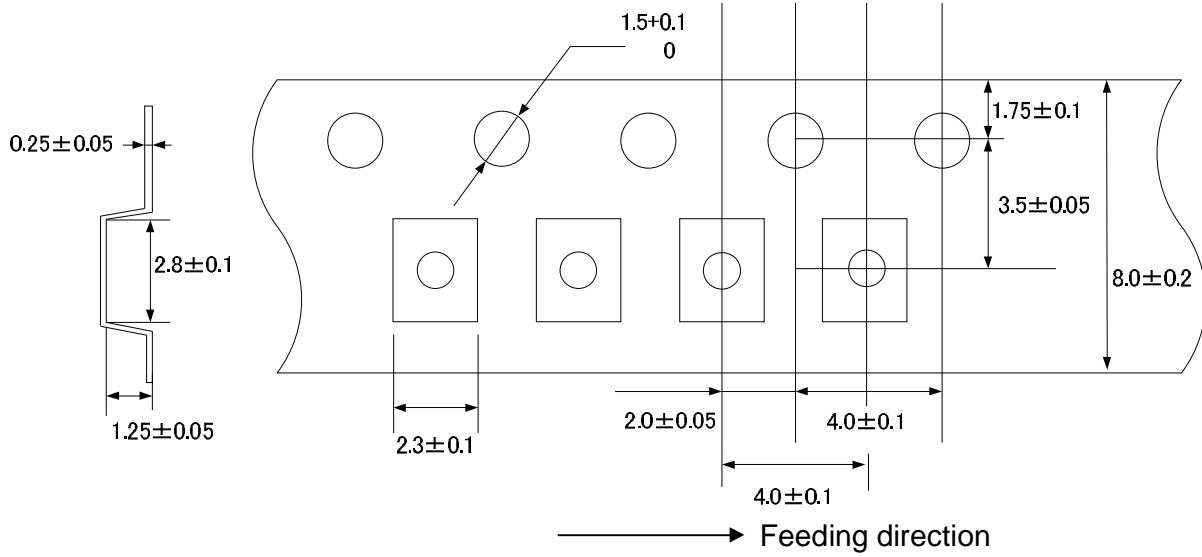

#### 2) Dimensions of Reel

Unit: mm

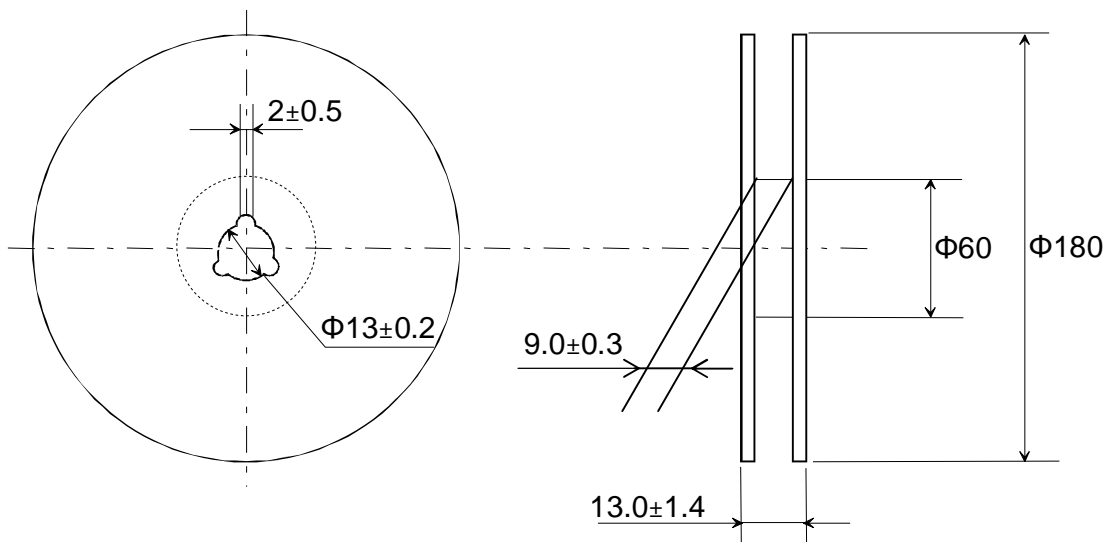

3) Taping Diagrams

- [1] Feeding Hole : As specified in (1)
- [2] Hole for chip : As specified in (1)
- [3] Cover tape : 50um in thickness
- [4] Base tape : As specified in (1)

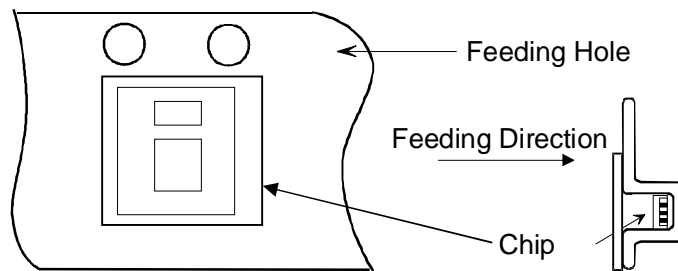
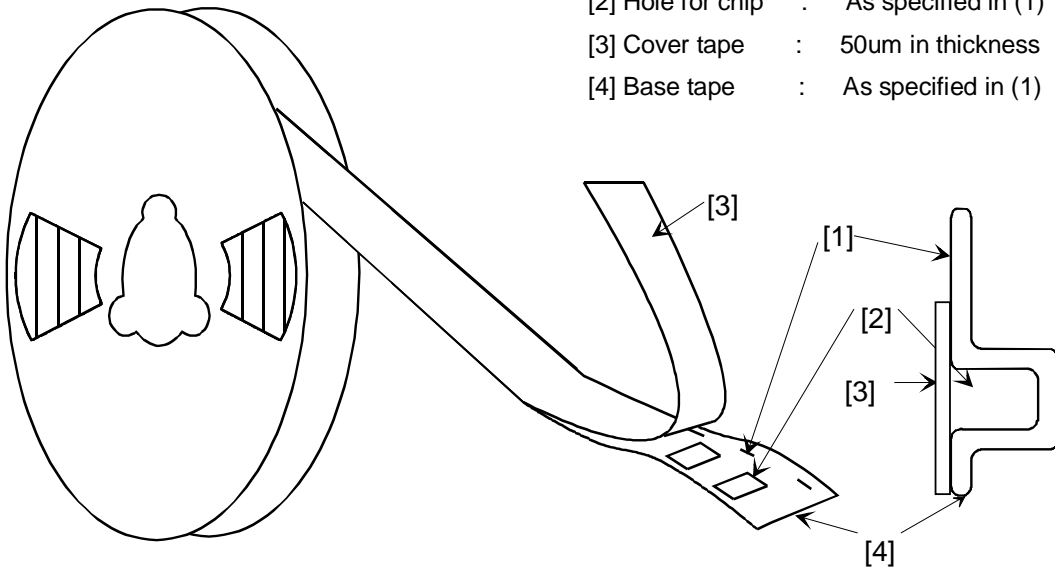

4) Leader and Tail tape

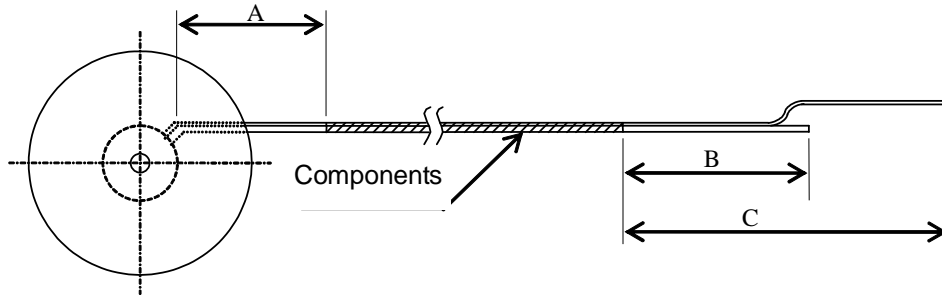

Symbol	Items	Ratings(mm)
A	No components at trailer	min 160
B	No components at leader	min 100
C	Whole leader	min 400

5) The tape for chips are wound clockwise, the feeding holes to the right side as the tape is pulled toward the user.

6) Packaging unit: 3,000 pcs./ reel

7) Material: Base Tape ... Plastic

Reel ... Plastic

Antistatic coating for both base tape and reel

8) Peeling of force

