

MOTOROLA SEMICONDUCTOR TECHNICAL DATA

Designer's Data Sheet

Power Field Effect Transistor N-Channel Enhancement-Mode Silicon Gate

These TMOS Power FETs are designed for medium voltage, high speed power switching applications such as switching regulators, converters, solenoid and relay drivers.

- Silicon Gate for Fast Switching Speeds — Switching Times Specified at 100°C
- Designer's Data — I_{DSS} , $V_{DS(on)}$, $V_{GS(th)}$ and SOA Specified at Elevated Temperature
- Rugged — SOA is Power Dissipation Limited
- Source-to-Drain Diode Characterized for Use With Inductive Loads



MTM12N10
***MTP12N10E**

*Motorola Preferred Device

TMOS POWER FETs
12 AMPERES
 $R_{DS(on)} = 0.18 \text{ OHM}$
100 VOLTS

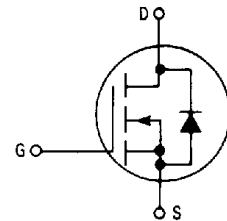

MAXIMUM RATINGS

Rating	Symbol	Value	Unit
Drain-Source Voltage	V_{DSS}	100	Vdc
Drain-Gate Voltage ($R_{GS} = 1 \text{ M}\Omega$)	V_{DGR}	100	Vdc
Gate-Source Voltage	V_{GS}	± 20	Vdc
Continuous Non-repetitive ($t_p \leq 50 \mu\text{s}$)	V_{GSM}	± 40	Vpk
Drain Current — Continuous	I_D	12	Adc
— Pulsed	I_{DM}	30	
Total Power Dissipation @ $T_C = 25^\circ\text{C}$ Derate above 25°C	P_D	75 0.6	Watts W/°C
Operating and Storage Temperature Range	T_J, T_{stg}	-65 to 150	°C

THERMAL CHARACTERISTICS

Thermal Resistance			°C/W
Junction to Case		$R_{\theta JC}$	1.67
Junction to Ambient	TO-204	$R_{\theta JA}$	30
	TO-220		62.5
Maximum Lead Temperature for Soldering Purposes, 1/8" from case for 5 seconds	TO-220	T_L	260
	TO-204		300

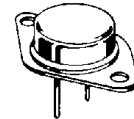

MTM12N10
CASE 1-07
TO-204AA

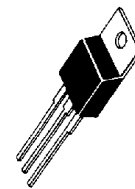

MTP12N10E
CASE 221A-06
TO-220AB

Preferred device is a Motorola recommended choice for future use and best overall value.

Designer's Data for "Worst Case" Conditions — The Designer's Data Sheet permits the design of most circuits entirely from the information presented. SOA Limit curves — representing boundaries on device characteristics — are given to facilitate "worst case" design.

MTM12N10, MTP12N10E

MOTOROLA SC (XSTRS/R F) 6AE D 6367254 0098579 662 MOT6

ELECTRICAL CHARACTERISTICS (T_C = 25°C unless otherwise noted)

Characteristic	Symbol	Min	Max	Unit
----------------	--------	-----	-----	------

OFF CHARACTERISTICS

Drain-Source Breakdown Voltage (V _{GS} = 0, I _D = 0.25 mA)	V _{(BR)DSS}	100	—	Vdc
Zero Gate Voltage Drain Current (V _{DS} = Rated V _{DSS} , V _{GS} = 0) (V _{DS} = Rated V _{DSS} , V _{GS} = 0, T _J = 125°C)	I _{DSS}	—	10 100	μAdc
Gate-Body Leakage Current, Forward (V _{GSM} = 20 Vdc, V _{DS} = 0)	I _{GSSF}	—	100	nAdc
Gate-Body Leakage Current, Reverse (V _{GSR} = 20 Vdc, V _{DS} = 0)	I _{GSSR}	—	100	nAdc

ON CHARACTERISTICS*

Gate Threshold Voltage (V _{DS} = V _{GS} , I _D = 1 mA) T _J = 100°C	V _{GS(th)}	2 1.5	4.5 4	Vdc
Static Drain-Source On-Resistance (V _{GS} = 10 Vdc, I _D = 6 Adc)	R _{DS(on)}	—	0.18	Ohm
Drain-Source On-Voltage (V _{GS} = 10 V) (I _D = 12 Adc) (I _D = 6 Adc, T _J = 100°C)	V _{DS(on)}	—	2.6 2.2	Vdc
Forward Transconductance (V _{DS} = 15 V, I _D = 6 A)	g _{FS}	3	—	mhos

DYNAMIC CHARACTERISTICS

Input Capacitance	V _{DS} = 25 V, V _{GS} = 0, f = 1 MHz See Figure 11	C _{iss}	—	800	pF
Output Capacitance		C _{oss}	—	400	
Reverse Transfer Capacitance		C _{rss}	—	100	

SWITCHING CHARACTERISTICS* (T_J = 100°C)

Turn-On Delay Time	V _{DD} = 25 V, I _D = 0.5 Rated I _D R _{gen} = 50 ohms See Figures 9, 13 and 14	t _{d(on)}	—	50	ns
Rise Time		t _r	—	150	
Turn-Off Delay Time		t _{d(off)}	—	200	
Fall Time		t _f	—	100	
Total Gate Charge	V _{DS} = 0.8 Rated V _{DSS} , I _D = Rated I _D , V _{GS} = 10 V See Figure 12	Q _g	17 (Typ)	36	nC
Gate-Source Charge		Q _{gs}	8 (Typ)	—	
Gate-Drain Charge		Q _{gd}	9 (Typ)	—	

SOURCE DRAIN DIODE CHARACTERISTICS*

Forward On-Voltage	I _S = Rated I _D V _{GS} = 0	V _{SD}	1.2 (Typ)	2.5	Vdc
Forward Turn-On Time		t _{on}	Limited by stray inductance		
Reverse Recovery Time		t _{rr}	325 (Typ)	—	ns

INTERNAL PACKAGE INDUCTANCE (TO-204)

Internal Drain Inductance (Measured from the contact screw on the header closer to the source pin and the center of the die)	L _d	5 (Typ)	—	nH
Internal Source Inductance (Measured from the source pin, 0.25" from the package to the source bond pad)	L _s	12.5 (Typ)	—	

INTERNAL PACKAGE INDUCTANCE (TO-220)

Internal Drain Inductance (Measured from the contact screw on tab to center of die) (Measured from the drain lead 0.25" from package to center of die)	L _d	3.5 (Typ) 4.5 (Typ)	—	nH
Internal Source Inductance (Measured from the source lead 0.25" from package to source bond pad.)	L _s	7.5 (Typ)	—	

*Pulse Test Pulse Width ≤ 300 μs, Duty Cycle ≤ 2%

3

MTM12N10, MTP12N10E

TYPICAL ELECTRICAL CHARACTERISTICS

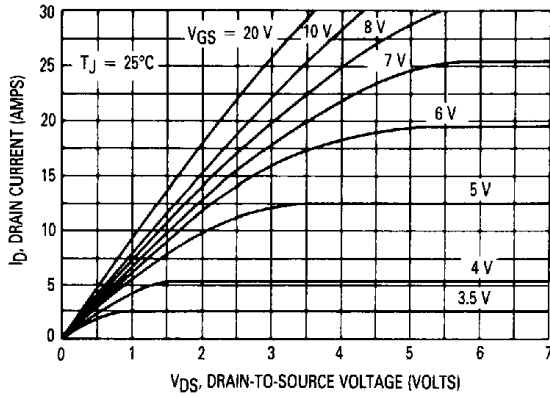

Figure 1. On-Region Characteristics

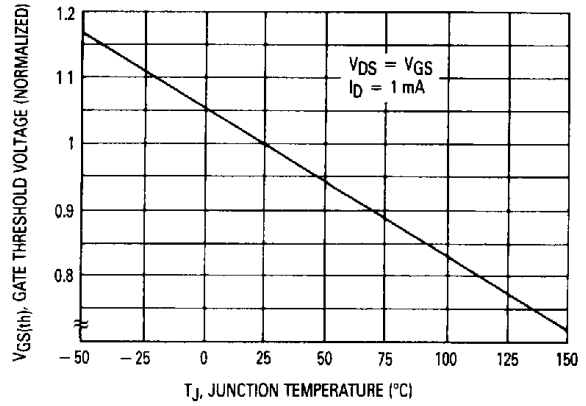

Figure 2. Gate-Threshold Voltage Variation With Temperature

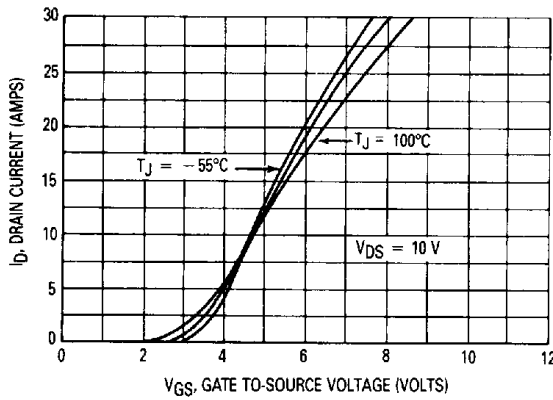

Figure 3. Transfer Characteristics

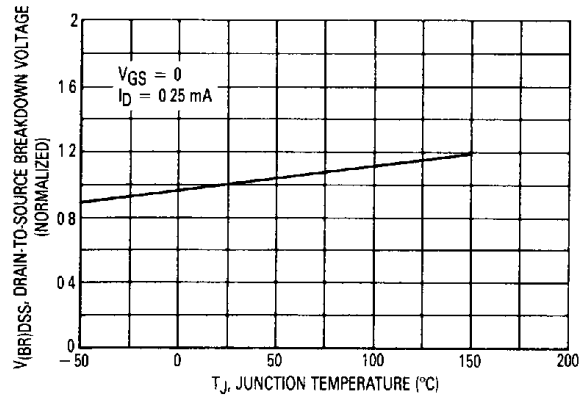

Figure 4. Breakdown Voltage Variation With Temperature

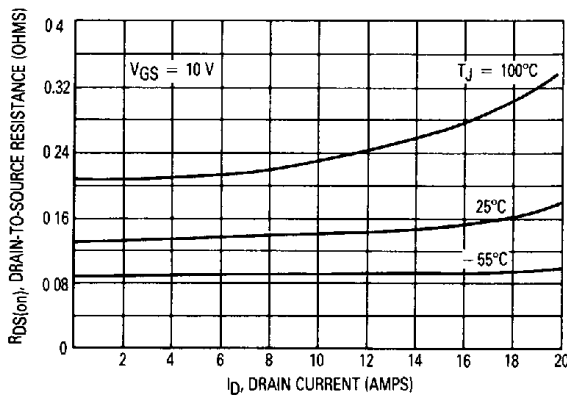

Figure 5. On-Resistance versus Drain Current

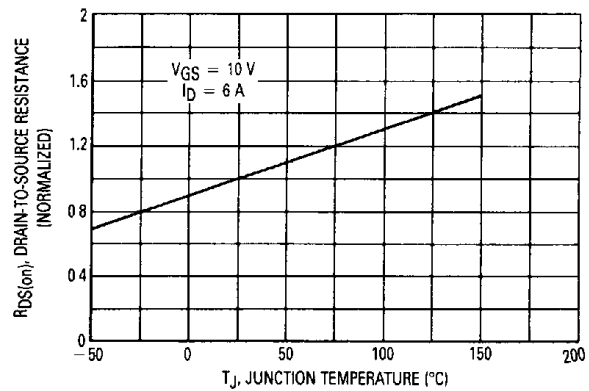

Figure 6. On-Resistance Variation With Temperature

SAFE OPERATING AREA INFORMATION

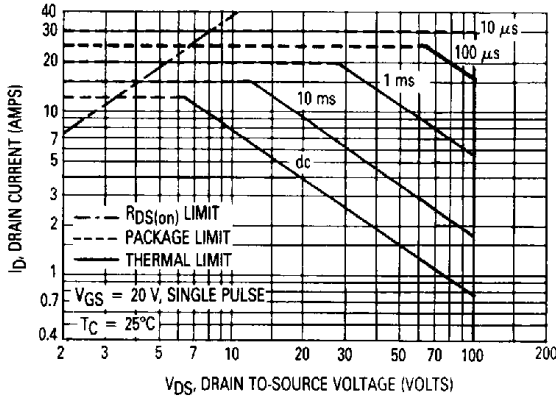

Figure 7. Maximum Rated Forward Biased Safe Operating Area

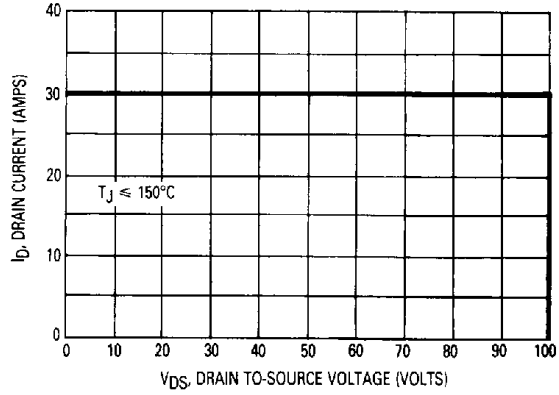

Figure 8. Maximum Rated Switching Safe Operating Area

FORWARD BIASED SAFE OPERATING AREA

The FBSOA curves define the maximum drain-to-source voltage and drain current that a device can safely handle when it is forward biased, or when it is on, or being turned on. Because these curves include the limitations of simultaneous high voltage and high current, up to the rating of the device, they are especially useful to designers of linear systems. The curves are based on a case temperature of 25°C and a maximum junction temperature of 150°C. Limitations for repetitive pulses at various case temperatures can be determined by using the thermal response curves. Motorola Application Note, AN569, "Transient Thermal Resistance-General Data and Its Use" provides detailed instructions.

SWITCHING SAFE OPERATING AREA

The switching safe operating area (SOA) of Figure 8 is the boundary that the load line may traverse without incurring damage to the MOSFET. The fundamental limits are the peak current, I_{DM} and the breakdown voltage, $V(BR)_{DSS}$. The switching SOA shown in Figure 8 is applicable for both turn-on and turn-off of the devices for switching times less than one microsecond.

The power averaged over a complete switching cycle must be less than:

$$\frac{T_J(\max) - T_C}{R_{\theta JC}}$$

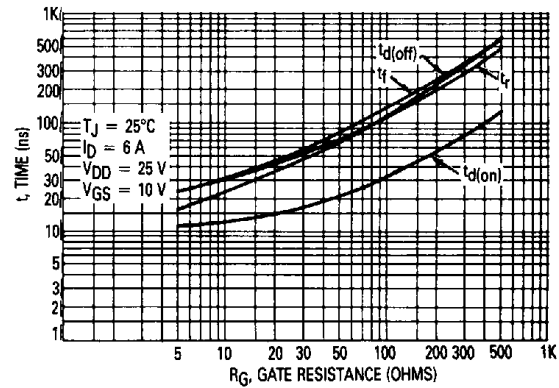

Figure 9. Resistive Switching Time versus Gate Resistance

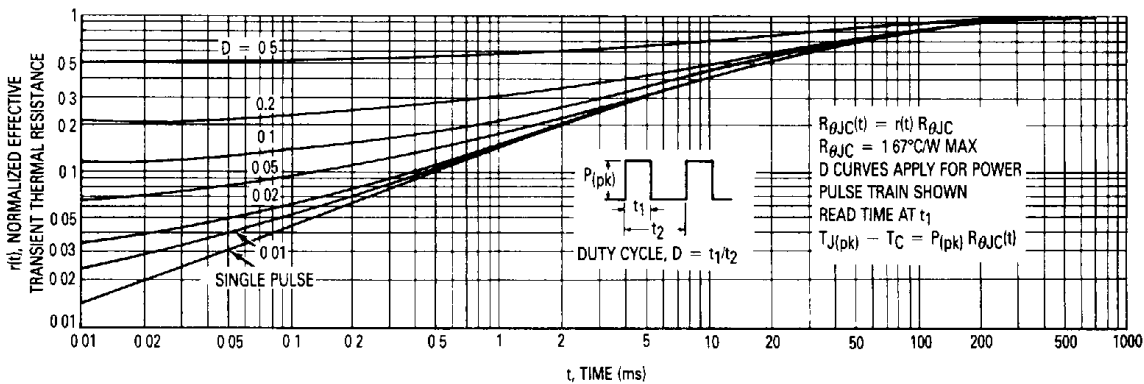

Figure 10. Thermal Response

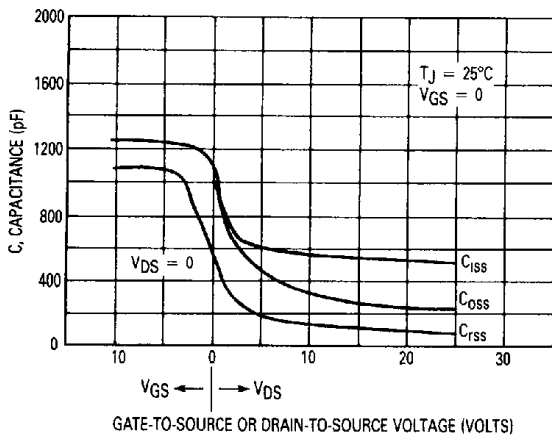

Figure 11. Capacitance Variation

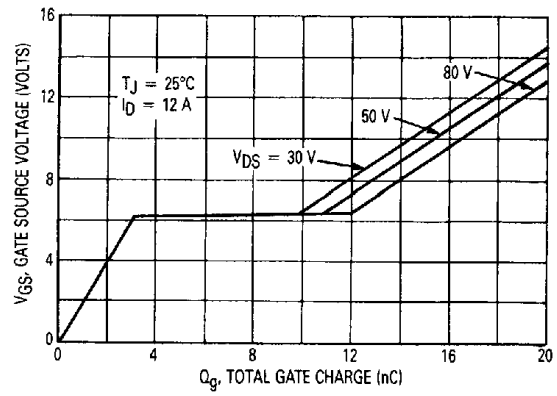

Figure 12. Gate Charge versus Gate-To-Source Voltage

3

RESISTIVE SWITCHING

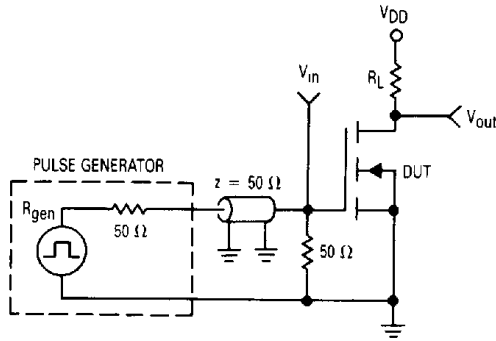

Figure 13. Switching Test Circuit

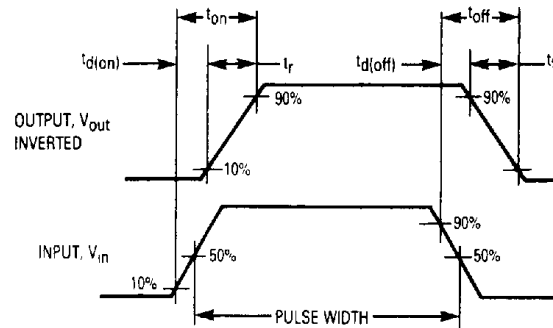

Figure 14. Switching Waveforms