



## AS Series • Current Sense Inductors & Transformers

**AS Series** Current Sensors are designed as a low cost method of controlling, monitoring or measuring AC currents. The sensors serve as feedback elements between the output and pulse control circuitry providing accurate regulation of switch mode power supplies.

### Features

- Fully encapsulated for optimal PC board mounting
- Frequency range from 20kHz to 200kHz
- Primary current rating to 30 Amps
- Primary to secondary isolated to 2500 VAC
- Meets VDE norms
- Optimum performance over designated current and frequency range
- Competitive pricing due to high volume production
- Manufactured in an ISO-9001:2000, TS-16949:2002 and ISO-14001:2004 certified facility
- Fully RoHS compliant

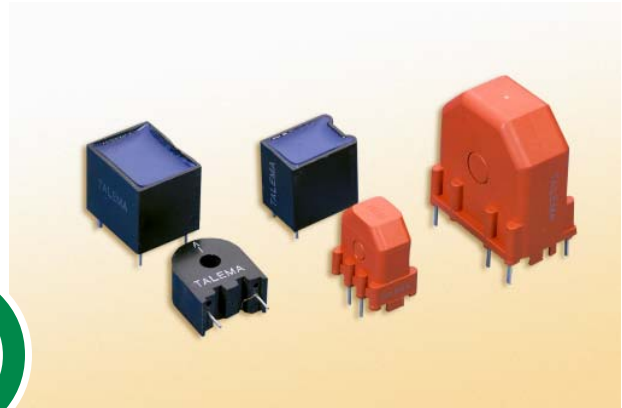

### Applications

- Isolated current feed-back signal in Switch Mode Power Supplies
- Motor current load/overload
- Lighting
- Switch Controls Ultra-sound current
- High resolution sonar current
- Isolated bi-directional current sensor with full wave bridge rectifier

### Electrical Specifications at 25°C

Part Number	Prim./Sec. Ratio	L <sub>sec</sub> <sup>(1)</sup> (mH Min)	DCR <sub>sec</sub> (Ohms Max.)	Sec. Term. <sup>(2)</sup> Resistance (Ohms Nom.)	I <sub>sec</sub> <sup>(3)</sup> Max.	Volt μS <sup>(4)</sup> Max.	Schematic
AS-100	1:50	6	0.6	50	300mA	175	
AS-101	1:100	25	1.1	100	150mA	350	
AS-102	1:200	100	4.5	200	75mA	700	
AS-103	1:300	250	10.0	300	50mA	900	
AS-104	1:500	700	25.0	500	30mA	1500	
AS-105	1:750	1682	43.0	750	40mA	3750	
AS-110	1:50CT	6	0.3 / 0.3	25 + 25	300mA	175	
AS-111	1:100CT	25	0.55 / 0.55	50 + 50	150mA	350	
AS-112	1:200CT	100	2.25 / 2.25	100 + 100	75mA	700	
AS-113	1:300CT	250	5.0 / 5.0	150 + 150	50mA	900	
AS-114	1:500CT	700	12.5 / 12.5	250 + 250	30mA	1500	
AS-115	1:750CT	1682	21.5 / 21.5	375 + 375	40mA	3750	

### Notes:

- 1) L<sub>sec</sub>: Secondary inductance tested at 10kHz and 10mV for 1:50 through 1:500 Prim./Sec. ratios and 1kHz/10mV for Prim./Sec. ratio of 1:750
- 2) This nominal termination resistance value will yield approximately 1.0V of output for each amp of current in a single turn sense line. The output Voltage/Ampere of these devices can be increased or decreased linearly over a restricted temperature range by adjusting the terminating resistance.
- 3) For Prim./Sec. Ratios of 1:50 through 1:500, the I<sub>sec</sub> value corresponds to a maximum primary current of 15 Amp-turns rms while the I<sub>sec</sub> value for the ratio of 1:750 corresponds to a max. primary current of 30 Amp-turns rms.
- 4)  $V_{\mu S} = R_t \times I_s \times \frac{1}{2F}$   
 Rt (Ohms): Recommended Terminating Resistance  
 Is (A): Secondary Current  
 F (Hz): Frequency
- 5) Operating Temperature Range: -40°C to +120°C
- 6) Pin 2 is on Center-Tapped (CT) versions only

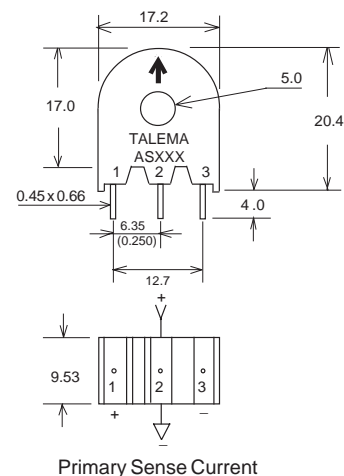

## AS Series • Current -Sense Inductors & Transformers

### Electrical Specifications at 25°C

Part Number		Prim./Sec. Ratio	L <sub>sec</sub> <sup>(1)</sup> (mHMin.)	DCR <sub>sec</sub> (Ohms Max.)	Sec. Term. <sup>(2)</sup> Resistance (Ohms Nom.)	I <sub>sec</sub> <sup>(3)</sup> Max.	Volt μS <sup>(4)</sup> Max.	Schematic
Type 1	Type 2							
AS-200	AS-300	1:50	5	0.65	50	300mA	175	
AS-201	AS-301	1:100	20	1.30	100	150mA	350	
AS-202	AS-302	1:200	80	4.50	200	75mA	700	
AS-210	AS-310	1:50CT	5	0.65	25 + 25	300mA	175	
AS-211	AS-311	1:100CT	20	1.30	50 + 50	150mA	350	
AS-212	AS-312	1:200CT	80	4.50	100 + 100	75mA	700	
	AS-320	1:50	5	0.65	50	300mA	175	
	AS-321	1:100	20	1.30	100	150mA	350	
	AS-322	1:200	80	4.50	200	75mA	700	
	AS-330	1:50CT	5	0.65	25 + 25	300mA	175	
	AS-331	1:100CT	20	1.30	50 + 50	150mA	350	
	AS-332	1:200CT	80	4.50	100 + 100	75mA	700	

**Type 1**

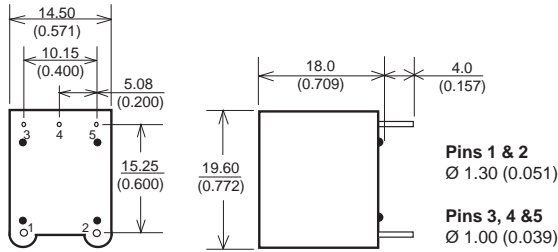

**Type 2**

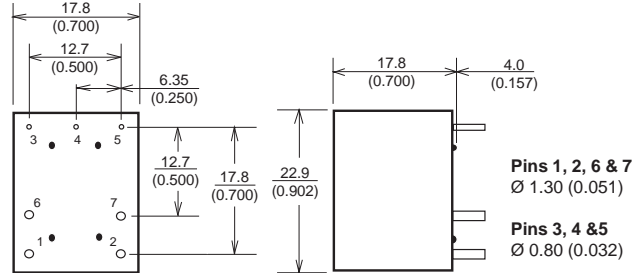

### Features

- Meets requirements of IEC 950 and VDE norms
- UL94, VO recognized materials
- Operating frequency range from 20kHz to 200kHz
- Operating Temperature Range: -40°C to +120°C
- Primary to secondary isolated to 4000 VAC
- Primary current rating to 80 Amps

### Electrical Specifications at 25°C

Part Number	Pri./Sec. Ratio	I <sub>p</sub> Amps	Volt μS (Max.)	Application	Schematic	Case Type	Dimensions							
							C	D	E	F	G	H	I	Hole
AS-400	1:100	1	350	Switching		A	17.8	12.8	20.0	10.0	5.0	15.0	5.0	--
AS-401	1:100	2	550	Switching		A	23.0	15.5	25.0	12.5	10.0	20.0	5.0	--
AS-402	1:100	5	1500	Switching		B	32.5	18.0	35.5	15.0	12.5	--	--	--
AS-403	1:100	10	1500	Switching		A	32.0	20.5	35.0	17.5	12.5	27.5	7.5	--
AS-404	1:100	50	1500	Switching		B	32.5	18.0	35.5	15.0	12.5	--	--	Ø 8
AS-405	1:500	50	2700	Switching		A	23.0	15.5	25.0	12.5	10.0	20.0	5.0	Ø 5
AS-406	1:500	65	4200	Switching		A	27.0	18.0	30.0	15.0	12.5	22.5	5.0	Ø 5
AS-407	1:500	80	7500	Switching		B	32.5	18.0	35.5	15.0	12.5	--	--	Ø 8

**Type A**

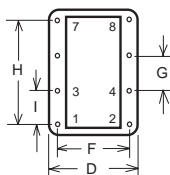
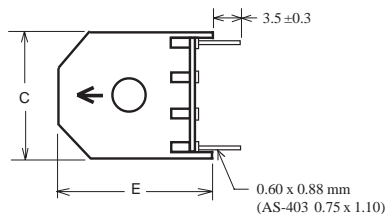

**Type B**

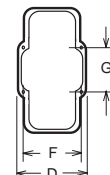
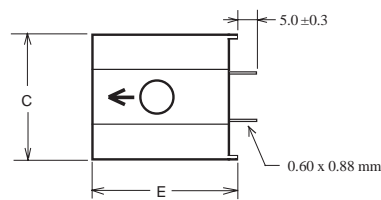

Germany: Int.+49 89 - 841 00-0 • Ireland: Int.+35 374 - 954 8666 • Czech Rep: Int.+420 377 - 338 351 • India: Int.+91 427 - 244 1325  
<http://www.talema-nuvotem.com>