

Features

- Low Noise Figure: 1.4 dB
- High Input IP3: +18 dBm at 8 V, 45 mA bias
+8 dBm at 3 V, 20 mA bias
- High Gain: 14 dB
- Single Supply: +3 to +8 VDC
- Adjustable current: 20 to 60 mA with external resistor
- Lead-Free SOIC-8 Package
- 100% Matte Tin Plating over Copper
- Halogen-Free "Green" Mold Compound
- 260°C Reflow Compatible
- RoHS* Compliant Version of AM50-0004

Description

M/A-COM's MAAMSS0045 is a high dynamic range, GaAs MMIC, low noise amplifier in a lead-free SOIC 8-lead, surface mount, plastic package. It employs external input matching to obtain optimum noise figure performance and operating frequency flexibility. The MAAMSS0045 also features flexible biasing to control the current consumption vs. dynamic range trade-off. The MAAMSS0045 can operate from any positive supply voltage in the 3 V to 8 V range. Its current can be controlled over a range of 20 mA to 60 mA with an external resistor.

The MAAMSS0045 is ideally suited for use where low noise figure, high gain, high dynamic range, and low power consumption are required. Typical applications included receiver front ends in PDC, DCS-1800, DCS-1900 and other PCN/PCS base stations. It is also useful as a gain block, buffer, driver, and IF amplifier in both fixed or portable PDC and PCN/PCS systems.

The MAAMSS0045 is fabricated using a low-cost 0.5-micron gate length GaAs process. The process features full passivation for increased performance and reliability. The MAAMSS0045 is 100% RF tested to ensure performance specification compliance.

Functional Block Diagram

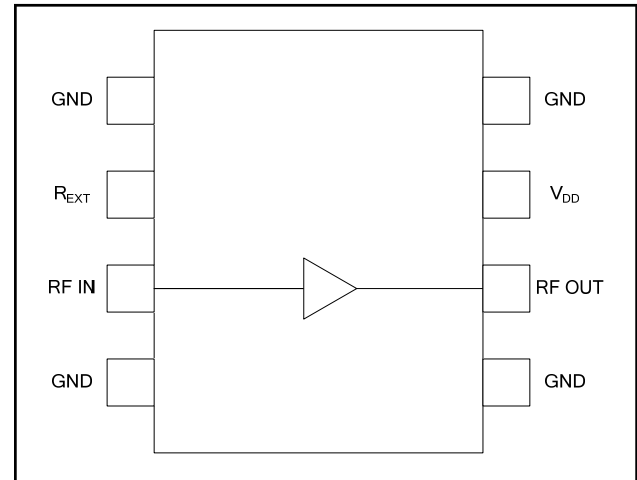

Pin Configuration

Pin No.	Pin Name	Description
1	GND	RF and DC Ground
2	R _{EXT}	External Current Control (optional)
3	RF IN	RF Input of the amplifier
4	GND	RF and DC Ground
5	GND	RF and DC Ground
6	RF OUT	RF Output of the amplifier
7	V _{DD}	Positive supply voltage
8	GND	RF and DC Ground

Ordering Information ^{1,2}

Part Number	Package
MAAMSS0045	Bulk Packaging
MAAMSS0045TR-3000	3000 piece reel
MAAMSS0045SMB	Sample Test Board

1. Reference Application Note M513 for reel size information.
2. All sample boards include 5 loose parts.

* Restrictions on Hazardous Substances, European Union Directive 2002/95/EC.

Electrical Specifications: $T_A = +25^\circ\text{C}$, $Z_0 = 50 \Omega$, $F = 1785 \text{ MHz}$, $P_{in} = -30 \text{ dBm}$

Parameter	Test Conditions	Units	Min.	Typ.	Max.
Gain	5 V, 45 mA ³	dB	12.0	14	—
	3 V, 20 mA	dB	—	12.5	—
Noise Figure	5 V, 45 mA ³	dB	—	1.4	1.8
	3 V, 20 mA	dB	—	1.5	—
Input VSWR	—	Ratio	—	1.5:1	—
Output VSWR	—	Ratio	—	2.0:1	—
Output 1 dB Compression	5 V, 45 mA ³	dBm	—	16.0	—
	3 V, 20 mA	dBm	—	9.0	—
Input IP3	5 V, 45 mA ³	dBm	13.0	15	—
	3 V, 20 mA	dBm	—	8.0	—
Reverse Isolation	—	dB	—	22	—
Drain Current	5 V, 45 mA ²	mA	30	45	60

3. Using external 15 Ω resistor. See functional schematic on page 3.

Absolute Maximum Ratings^{4,5}

Parameter	Absolute Maximum
V_{DD}	+10 VDC
Input Power	+17 dBm
Current ⁶	80 mA
Channel Temperature ⁷	+150°C
Operating Temperature	-40°C to +85°C
Storage Temperature	-65°C to +150°C

4. Exceeding any one or combination of these limits may cause permanent damage.
5. M/A-COM does not recommend sustained operation near these survivability limits.
6. When pin #2 is used to increase current. (See note 9)
7. Thermal resistance (θ_{jc}) = +99°C/W.

Handling Procedures

Please observe the following precautions to avoid damage:

Static Sensitivity

Gallium Arsenide Integrated Circuits are sensitive to electrostatic discharge (ESD) and can be damaged by static electricity. Proper ESD control techniques should be used when handling these devices.

Functional Schematic

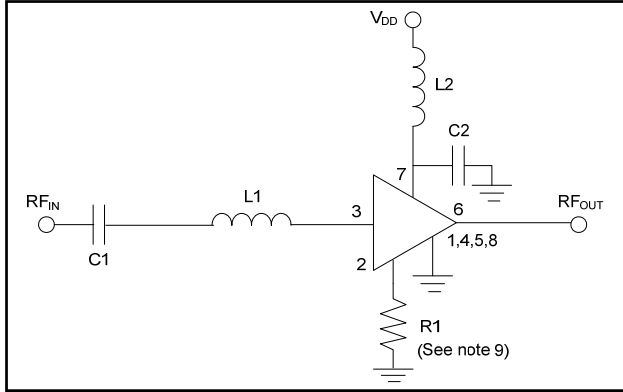

External Components List ⁸

Part	Value	Case Size	Manufacturer	Purpose
C1	47 pF	0603	Murata	DC Block
C2	47 pF	0603	Murata	By-Pass
L1	3.9 nH	0603	Coilcraft	Tuning
L2	12 nH	0603	Coilcraft	RF Choke
R1	see note 9	0603	Panasonic	Optional current control

- All external circuitry parts are readily available, low cost surface mount components (.060 in. x .030 in. or .080 in. x .050 in.).
- Pin 2 allows use of an external resistor to ground for optional, higher current. For 20 mA operation, no resistor is used.

For $I_{DD} \sim 30$ mA, $R1 = 39$ ohms;
 $I_{DD} \sim 45$ mA, $R1 = 15$ ohms;
 $I_{DD} \sim 60$ mA, $R1 = 6$ ohms.

Lead-Free SOIC-8[†]

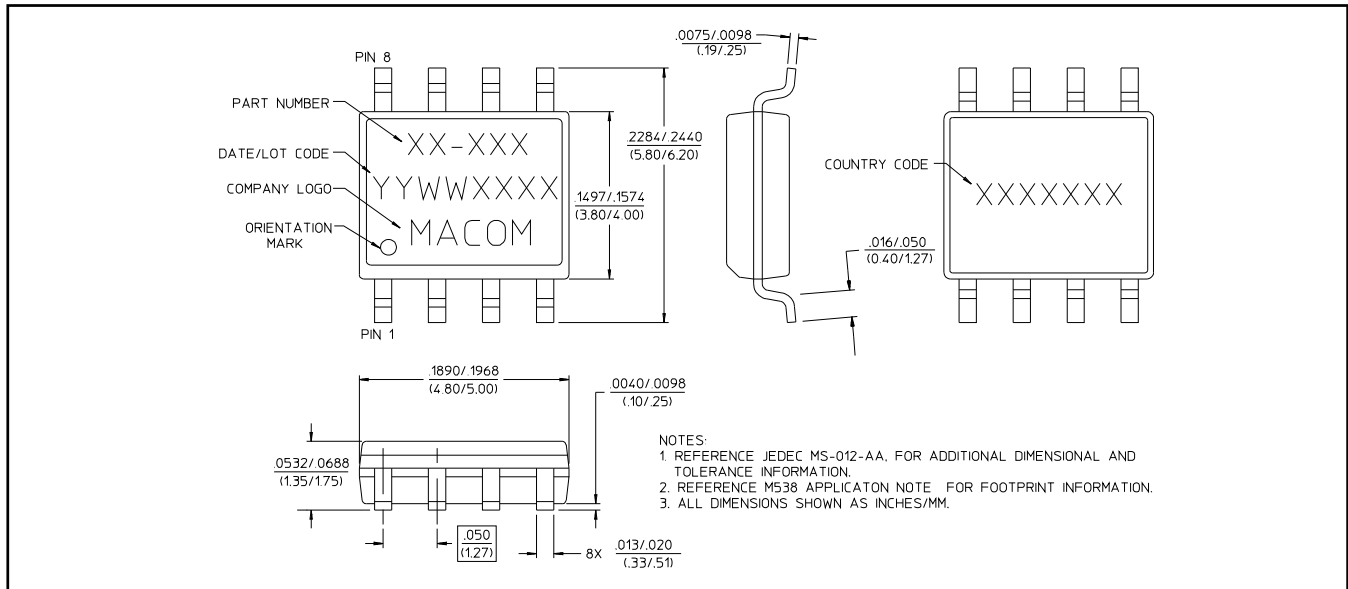

[†] Reference Application Note M538 for lead-free solder reflow recommendations.
 Meets JEDEC moisture sensitivity level 1 requirements.

Recommended PCB Configuration

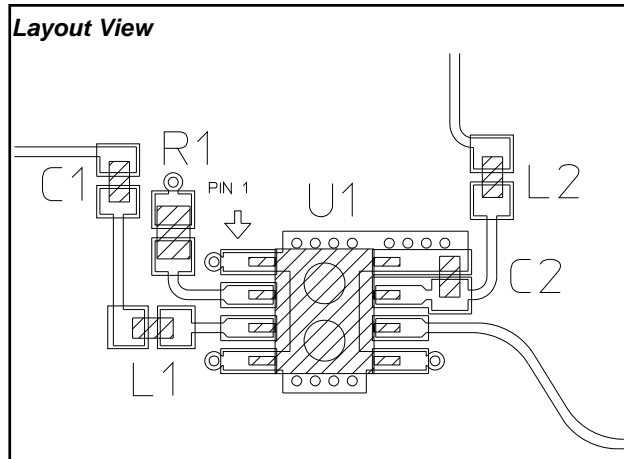

Cross Section View

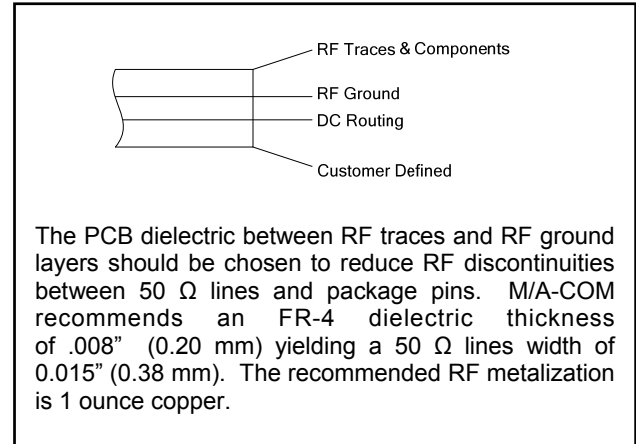

Designer's Kit MAAMSS0045SMB

The MAAMSS0045SMB Designer's Kit allows for immediate evaluation of M/A-COM's MAAMSS0045. The Designer's Kit includes an MAAMSS0045 mounted on an evaluation board and five loose MAAMSS0045's. The evaluation board consists of the recommended external surface mount circuitry, RF connectors, and a DC multi-pin connector, all mounted to a multi-layer FR-4 PCB. The MAAMSS0045SMB evaluation PCB is illustrated below with all functional ports labeled.

MAAMSS0045 Evaluation Board

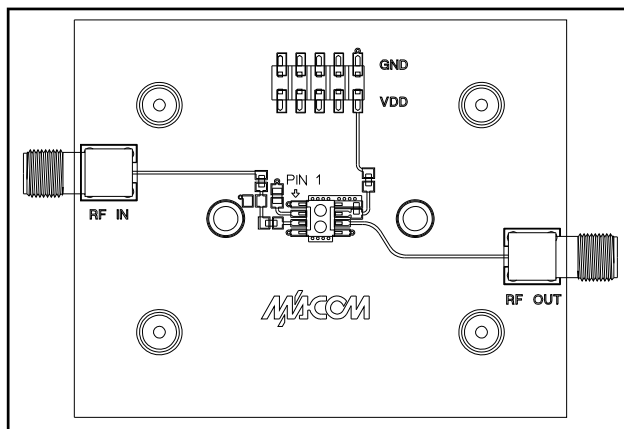

Evaluation PCB & RF Connector Losses

Port Reference	Approximate RF Loss
RF In	0.15 dB @ 1785 MHz
RF Out	0.15 dB @ 1785 MHz

The DC connector on the Designer's Kit PCB allows convenient DC line access. This is accomplished by the one or more of the following methods.

1. A mating female multi-pin connector (Newark Electronics Stock # 46F-4658, not included).
2. Wires soldered to the necessary pins (not included).
3. Clip leads (not included).

Typical Performance Curves

$T_A = +25^\circ\text{C}$, $Z_0 = 50 \Omega$, $V_{DD} = 5 \text{ V}$, $I_{DD} = 45 \text{ mA}$ unless otherwise specified.

Gain vs. Frequency

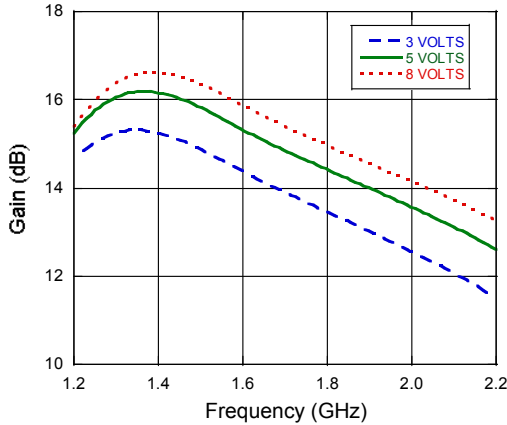

VSWR vs. Frequency

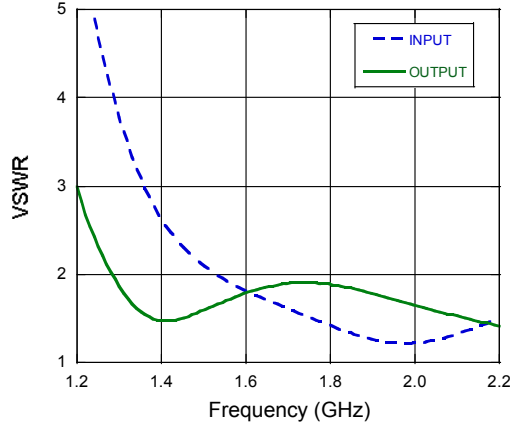

Noise Figure vs. Frequency

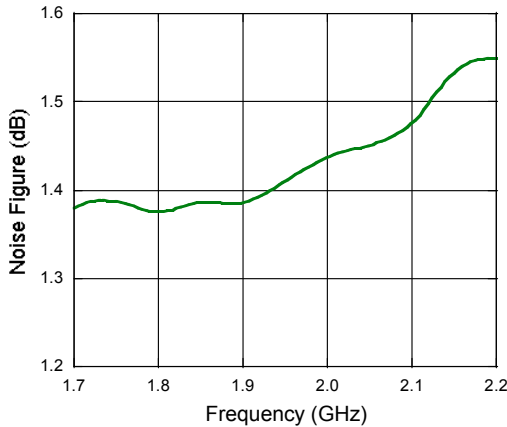

Noise Figure vs. Current, F = 1785 MHz

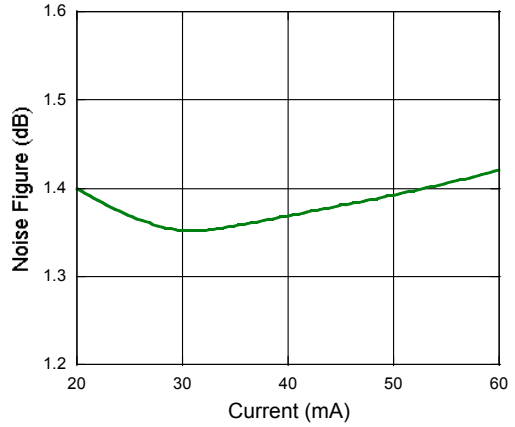

Output P1 dB vs. Frequency

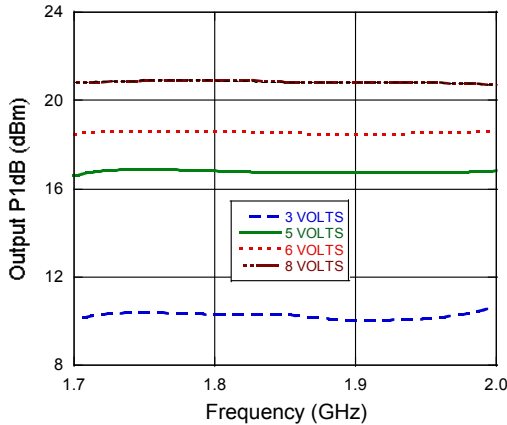

Output P1 dB vs. Current, F = 1785 MHz

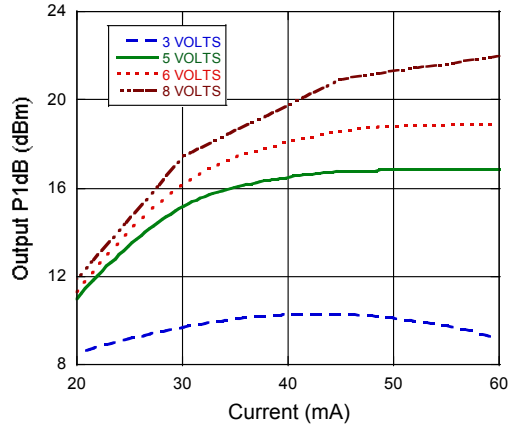

ADVANCED: Data Sheets contain information regarding a product M/A-COM Technology Solutions is considering for development. Performance is based on target specifications, simulated results, and/or prototype measurements. Commitment to develop is not guaranteed.
PRELIMINARY: Data Sheets contain information regarding a product M/A-COM Technology Solutions has under development. Performance is based on engineering tests. Specifications are typical. Mechanical outline has been fixed. Engineering samples and/or test data may be available. Commitment to produce in volume is not guaranteed.

- **North America** Tel: 800.366.2266 / Fax: 978.366.2266
- **Europe** Tel: 44.1908.574.200 / Fax: 44.1908.574.300
- **Asia/Pacific** Tel: 81.44.844.8296 / Fax: 81.44.844.8298

Visit www.macomtech.com for additional data sheets and product information.

M/A-COM Technology Solutions Inc. and its affiliates reserve the right to make changes to the product(s) or information contained herein without notice.

Typical Performance Curves

$T_A = +25^\circ\text{C}$, $Z_0 = 50 \Omega$, $V_{DD} = 5 \text{ V}$, $I_{DD} = 45 \text{ mA}$ unless otherwise specified.

Input IP3 vs. Frequency

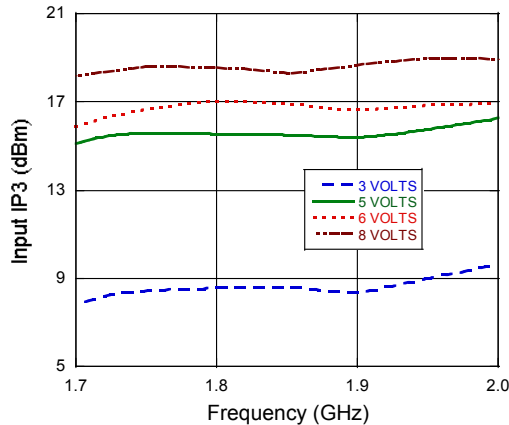

Input IP3 vs. Current, $F = 1785 \text{ MHz}$

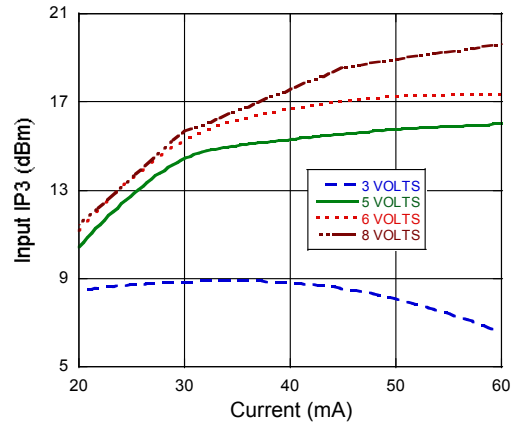

Gain vs. Temperature

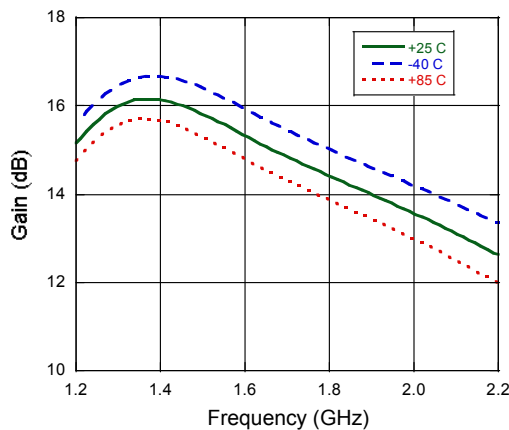

Noise Figure vs. Temperature

