

High Output IP3 Driver Amplifier 1700 - 2500 MHz

**MAAMSS0007
V4**

Features

- 42 dBm Output IP3
- 24 dBm P1dB
- Chip Scale Leadless Package
- Single Positive Supply Voltage

Description

M/A-COM's MAAMSS0007 RF driver amplifier is a GaAs MMIC which exhibits high OIP3 as well as high gain and low power consumption in a low-cost 3 mm PQFN surface mount plastic package.

The MAAMSS0007 employs a monolithic single stage design featuring a convenient 50-ohm input/output impedance that minimizes the number of external components required. The device runs off a single +5 volt supply and draws 100 mA typically. The design provides excellent performance from 1700 to 2500 MHz.

The MAAMSS0007 is fabricated using M/A-COM's iHBT process to realize low current and high power functionality. The process features full passivation for increased performance and reliability.

Ordering Information ¹

Part Number	Package
MAAMSS0007	Bulk Packaging
MAAMSS0007SMB	Sample Kit
MAAMSS0007TR	1000 piece reel
MAAMSS0007TR-3000	3000 piece reel

1. Reference Application Note M513 for reel size information.

Functional Block Diagram

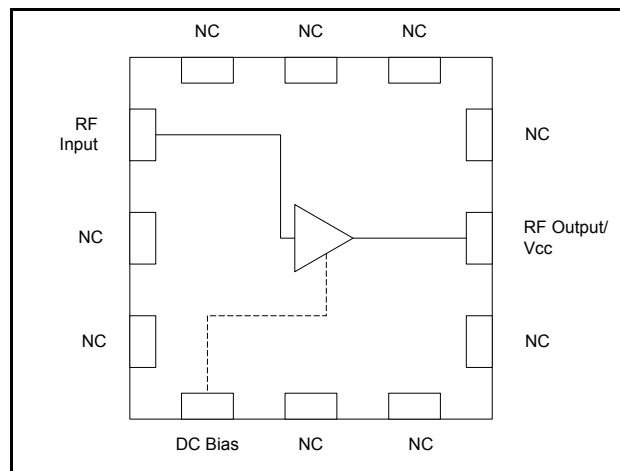

Pin Configuration ²

Pin No.	Function	Pin No.	Function
1	RF Input	7	No Connection
2	No Connection	8	RF Output/Vcc
3	No Connection	9	No Connection
4	DC Bias	10	No Connection
5	No Connection	11	No Connection
6	No Connection	12	No Connection

2. The exposed pad centered on the package bottom must be connected to RF and DC ground.

Absolute Maximum Ratings ³

Parameter	Absolute Maximum
RF Input Power ⁴	8 dBm
Voltage	6.0 volts
Operating Temperature	-40 °C to +85 °C
Storage Temperature	-65 °C to +150 °C

3. Exceeding any one or combination of these limits may cause permanent damage to this device.

4. The MAAMSS0007 is designed to operate optimally at 10 dB backed off from its output P1dB of 24.5 dBm. Driving the device at higher power levels could degrade performance.

High Output IP3 Driver Amplifier
1700 - 2500 MHz

MAAMSS0007
V4

Electrical Specifications⁵: $T_A = +25^\circ\text{C}$, $V_{CC} = 5\text{ V}$, $Z_0 = 50\Omega$

Parameter	Test Conditions	Units	Min	Typ	Max
Gain ⁶	2050 MHz	dB	12	13	15
Noise Figure ⁷	2050 MHz	dB	—	5.5	—
Input Return Loss	2050 MHz	dB	10	12	—
Output Return Loss	2050 MHz	dB	10	15	—
Output P1dB	2050 MHz	dBm	—	24.5	—
Output IP3	Two tone, -5 dBm/tone, 10 MHz spacing, 2050 MHz	dBm	—	42	—
Current	$V_{CC} = 5\text{ V}$	mA	80	100	120

5. $P_{in} \leq 0\text{ dBm}$ unless otherwise specified.
 6. Gain varies at $-0.008\text{ dB}/^\circ\text{C}$ typical.
 7. Noise figure varies at $0.017\text{ dB}/^\circ\text{C}$ typical.

Operating the MAAMSS0007

The MAAMSS0007 can be damaged by electrostatic discharge (ESD). Use proper ESD control techniques when handling this device. To operate the MAAMSS0007, follow these steps.

1. Apply V_{CC} (5.0 V).
2. Set P_{IN} .
3. Turn off in reverse order.

Schematic Including Off-Chip Components for 1700 - 2500 MHz

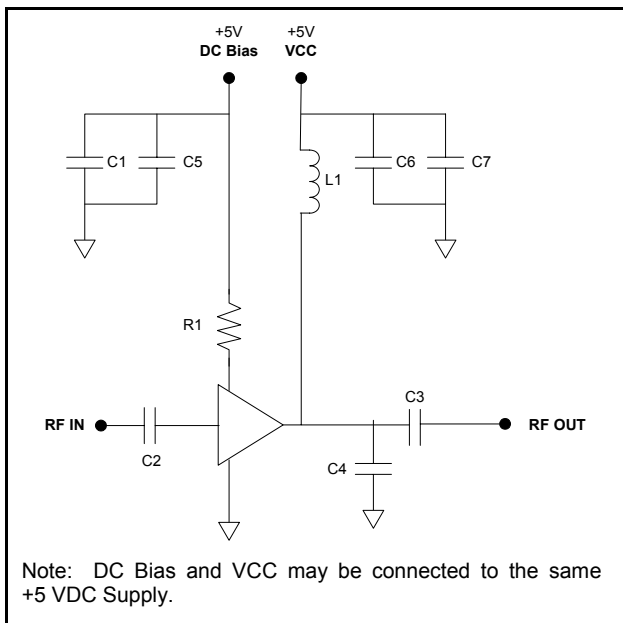

Component List

Part	Value	Case Size	Manufacturer
C1,C6	1000 pF	0402	Murata
C2	1.5 pF	0402	Murata
C3	39 pF	0402	Murata
C4	0.3 pF	0402	ATC
C5,C7	0.01 pF	0402	Murata
L1	33 nH	0603	Coilcraft
R1	634 Ohms	0402	Panasonic

PCB Layout

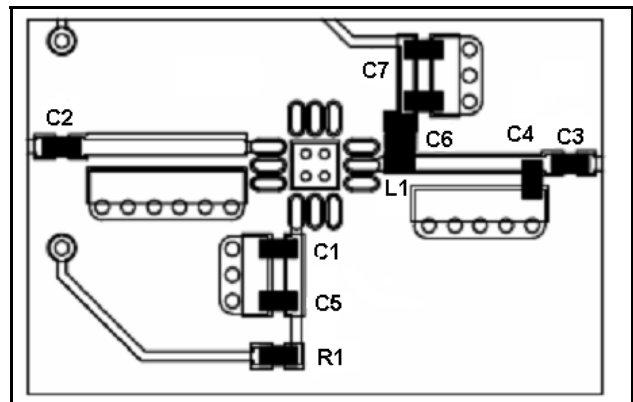

Typical Performance Curves

Gain

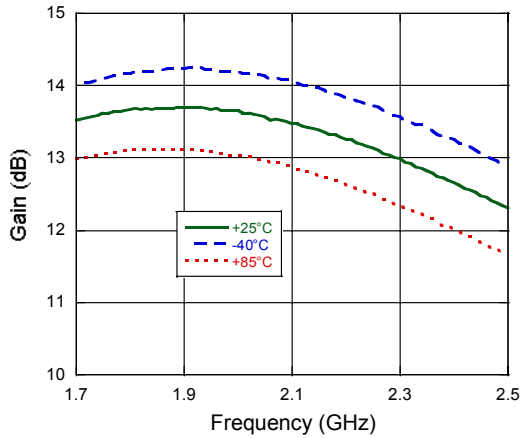

Gain vs. Voltage

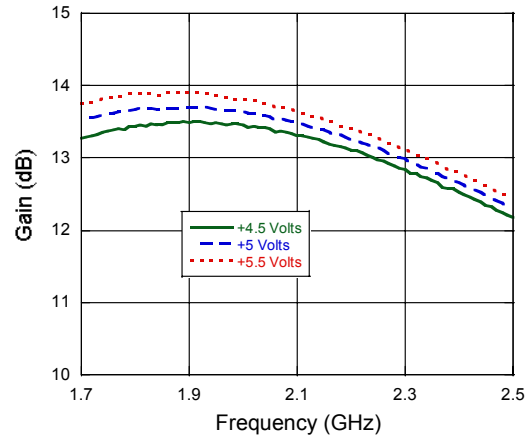

Input Return Loss

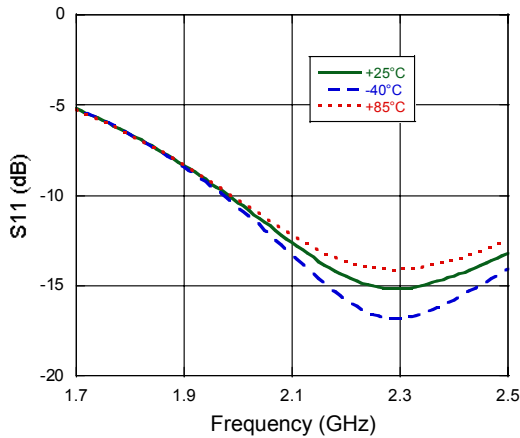

Output Return Loss

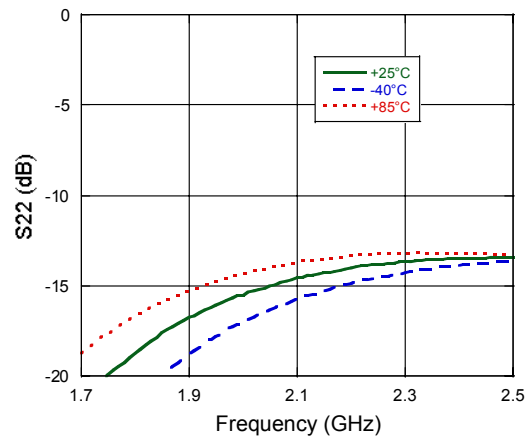

Noise Figure

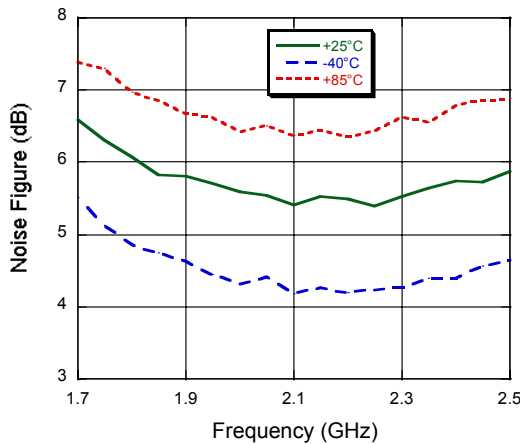

Reverse Isolation

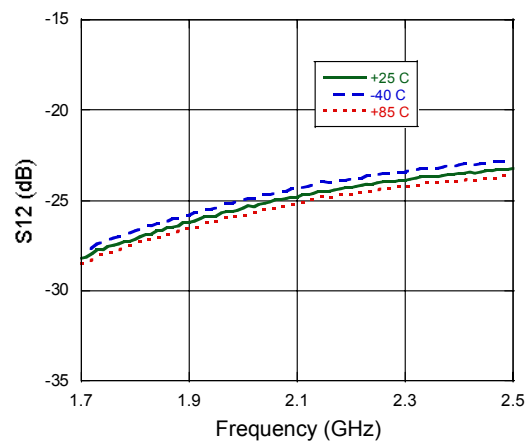

**High Output IP3 Driver Amplifier
1700 - 2500 MHz**

**MAAMSS0007
V4**

Typical Performance Curves

OIP3 (Pin = -5 dBm/tone)

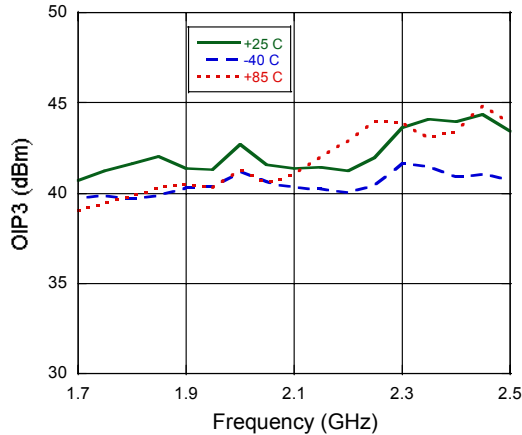

OIP3 vs. Pin @ 2050 MHz

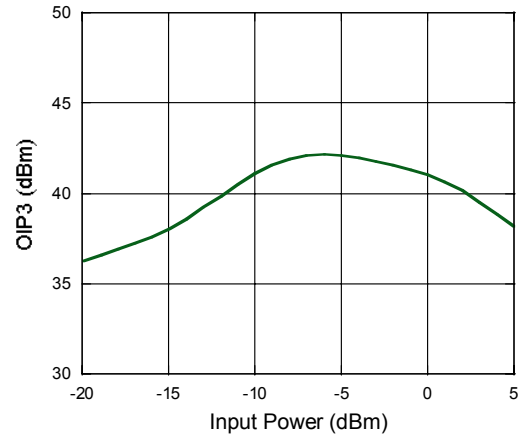

OIP3 vs. Voltage (Pin = -5 dBm/tone)

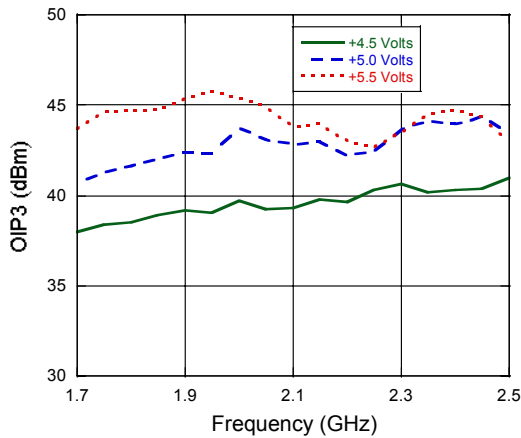

P1dB

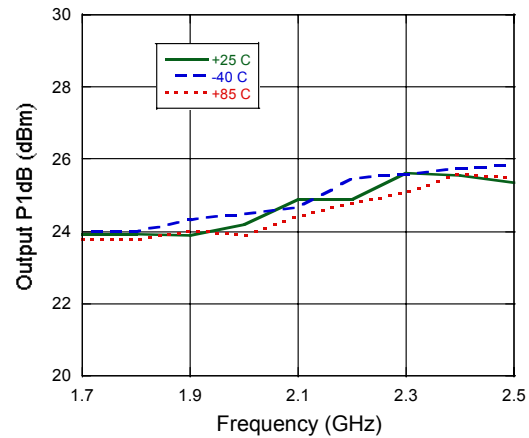

**ACPR Performance, 9 Channels Forward,
Vcc = 5V, Icc = 100 mA**

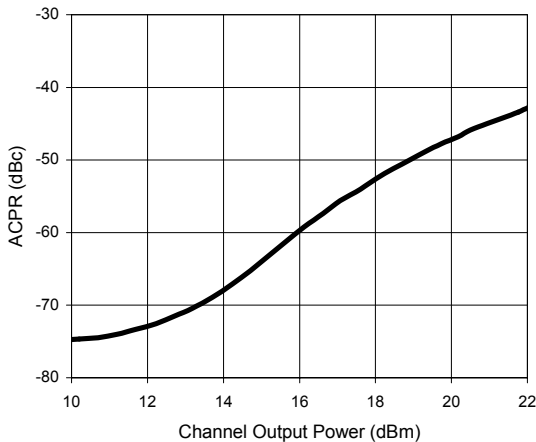

High Output IP3 Driver Amplifier
1700 - 2500 MHz

MAAMSS0007
V4

3 mm 12-Lead PQFN

