

Low Noise Amplifier
1.7 - 2.0 GHz

MAAM12031
V4

Features

- Low Noise Figure: 1.65 dB
- High Gain: 20 dB
- Low Power Consumption: 3 to 5 V, 8 mA
- High Dynamic Range
- DC Decoupled RF Input and Output
- No External RF Tuning Elements Necessary
- Low Cost SOIC-8 Plastic Package

Description

M/A-COM's MAAM12031 is a high performance GaAs MMIC low noise amplifier in a low cost SOIC 8-lead surface mount package. The MAAM12031 employs a fully monolithic design which eliminates the need for external tuning networks. It can be biased using 3 or 5 volt supplies and has an option for biasing at higher currents for increased dynamic range.

The MAAM12031 is ideally suited for use where low noise figure, high gain, high dynamic range and low power consumption are required. Typical applications include receiver front ends in the Japanese Personal Handy Phone Service (PHS), Private Branch Exchange (PBX) and Personal Communications and Networks (PCS, PCN) markets, as well as standard gain blocks, buffer amps, driver amps and IF amps in both fixed and portable systems.

M/A-COM's MAAM12031 is fabricated using a mature 0.5-micron gate length GaAs process. The process features full passivation for increased performance reliability.

Ordering Information

Part Number	Package
MAAM12031	Bulk Packaging
MAAM12031TR	1000 piece reel
MAAM12031SMB	Sample Test Board

Note: Reference Application Note M513 for reel size information.

Functional Schematic

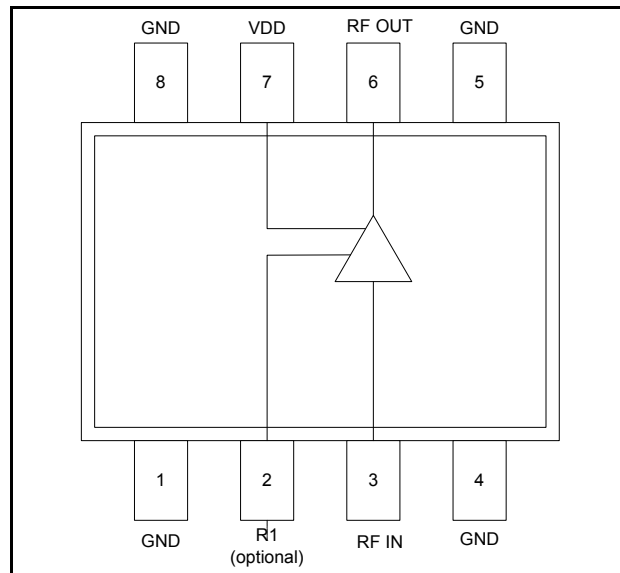

Pin Configuration

Pin No.	Function	Pin No.	Function
1	Ground	5	Ground
2	R1 (Optional) See note 3	6	RF Output
3	RF Input	7	VDD
4	Ground	8	Ground

1. Pins 1, 4, 5 and 8 must be RF and DC grounded as shown.
2. Pin 3 is the RF input, pin 6 is the RF output. VDD is applied on pin 7. This pin must be bypassed with a 500 pF surface mount MLC capacitor, mounted as close as possible to pin 7, and RF decoupled with a chip inductor having a minimum value of 15 nH (as shown in the Recommended PCB Configuration).
3. Pin 2 allows use of an external resistor to ground for optional, higher current bias. For nominal current operation no resistor is used. For optional 20 mA current operation, connect a 35 to 40 ohm chip resistor (as show in the Recommended PCB Configuration).

Low Noise Amplifier
1.7 - 2.0 GHz

MAAM12031
V4

Electrical Specifications⁴: $T_A = 25^\circ\text{C}$, $Z_0 = 50 \Omega$, $V_{DD} = +5 \text{ V}$, $\text{PIN} = -30 \text{ dBm}$

Parameter	Test Conditions	Units	Min	Typ	Max
Gain	—	dB	18	20	22
Noise Figure	—	dB	—	1.65	2.00
Input VSWR	—	Ratio	—	1.7:1	—
Output VSWR	—	Ratio	—	1.7:1	—
Output 1 dB Copression	—	dBm	—	7	—
Input IP3	—	dBm	—	-1	—
Reverse Isolation	—	dB	—	38	—
Bias Current	—	mA	5	8	11

4. See 3 V data herein.

Absolute Maximum Ratings⁵

Parameter	Absolute Maximum
VDD	+10 VDC
Input Power	+17 dBm
Current ⁶	30 mA
Channel Temperature ⁷	+150°C
Operating Temperature	-40°C to +85°C
Storage Temperature	-65°C to +150°C

5. Exceeding any one or combination of these limits may cause permanent damage to this device.
 6. Only if Pin 2 is used to increase current (See Note 3 herein).
 7. Typical thermal resistance (θ_{jc}) = +165°C/W.

Application Schematic

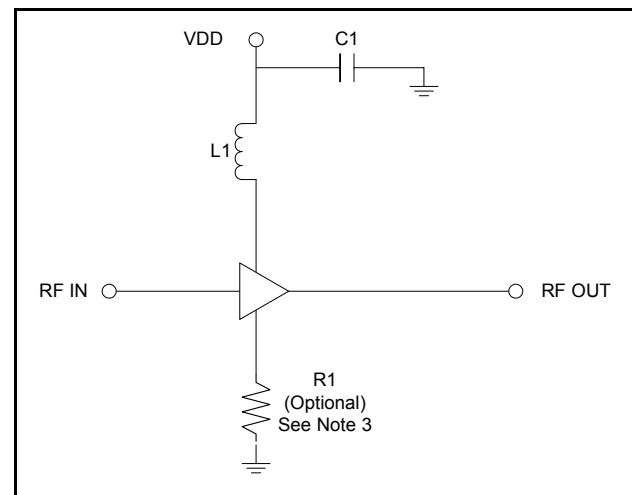

Component List

Part	Value	Case Size	Manufacturer
C1	500 pF	0603	Murata
L1	15 nH	0805	Coilcraft
R1 (Optional)	35/40 Ω	0603	Panasonic

Low Noise Amplifier
1.7 - 2.0 GHz

MAAM12031
V4

Recommended PCB Configuration

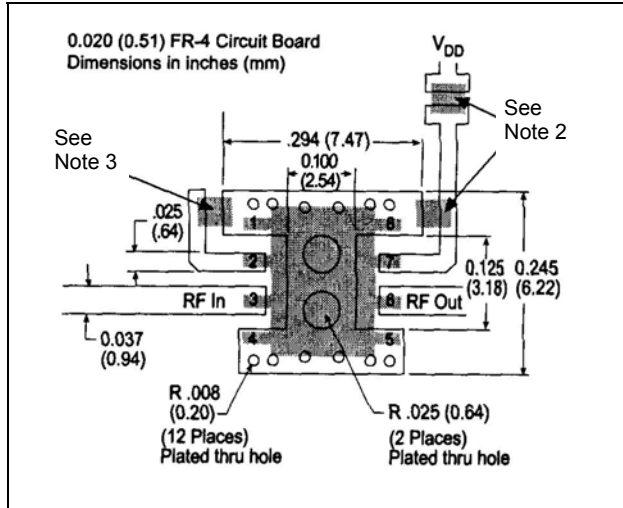

Handling Procedures

Please observe the following precautions to avoid damage:

Static Sensitivity

Gallium Arsenide Integrated Circuits are sensitive to electrostatic discharge (ESD) and can be damaged by static electricity. Proper ESD control techniques should be used when handling these devices.

SOIC-8

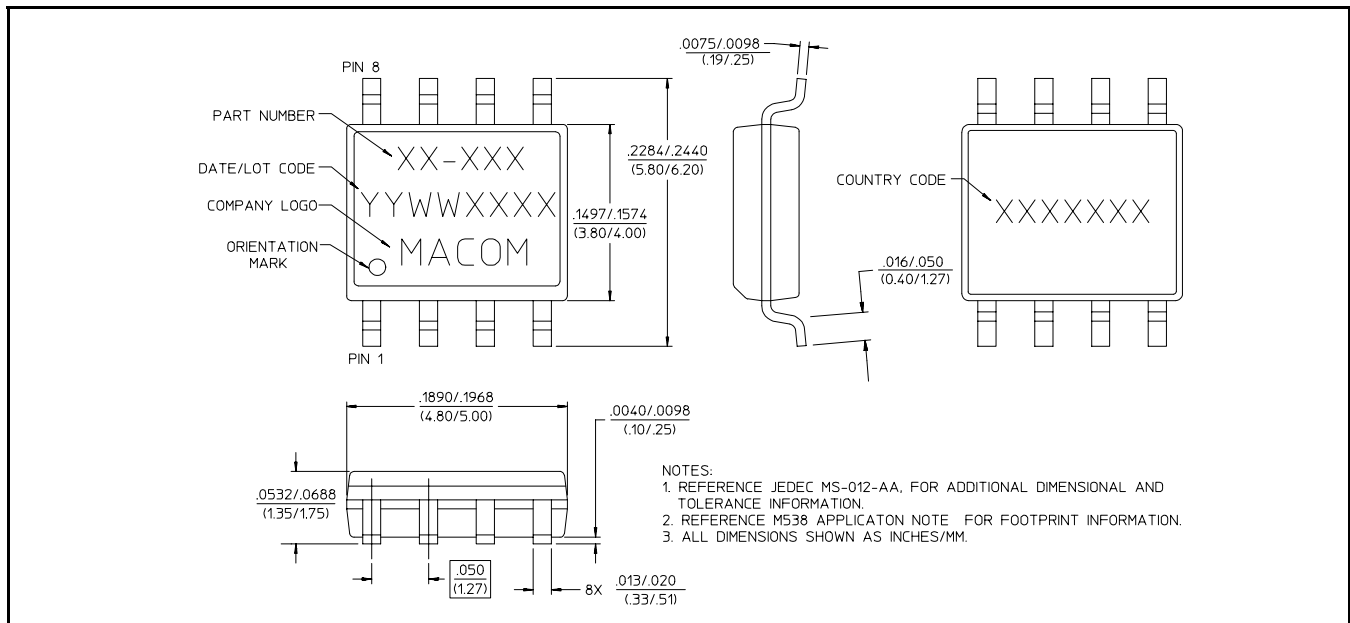

Low Noise Amplifier
1.7 - 2.0 GHz

MAAM12031
V4

Typical Performance Curves

Gain @ +25°C

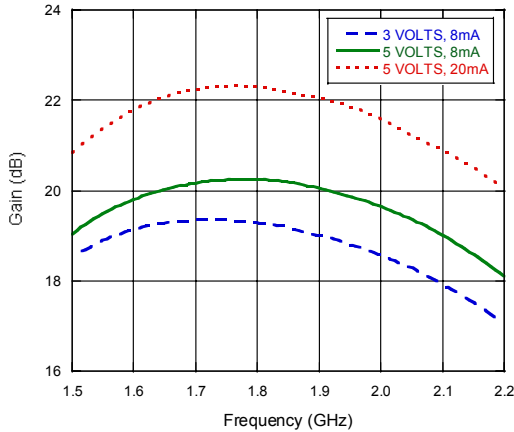

Noise Figure @ +25°C

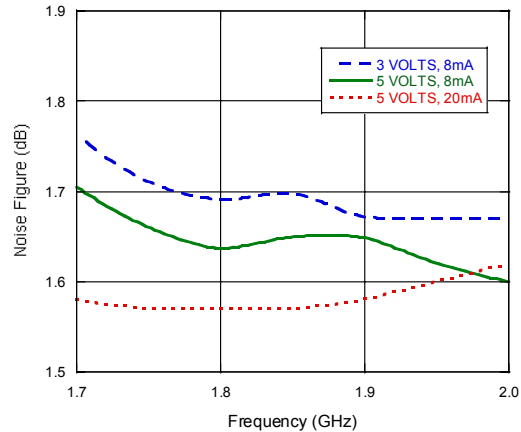

VSWR @ 5 V, 8 mA, +25°C

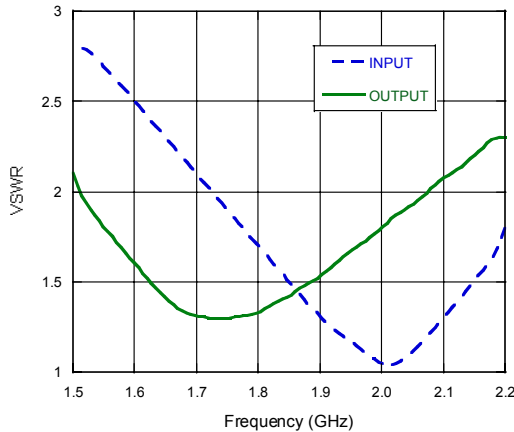

Input IP3 @ +25°C

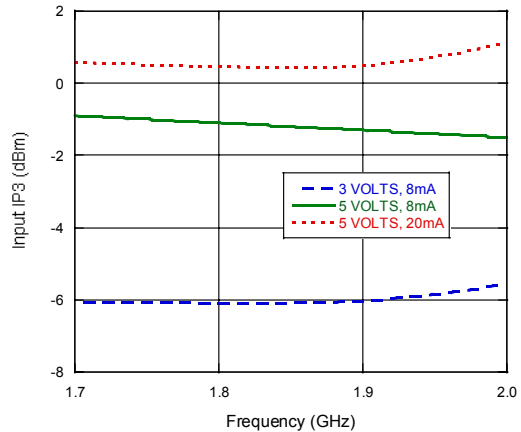

Gain @ 5 V, 8 mA

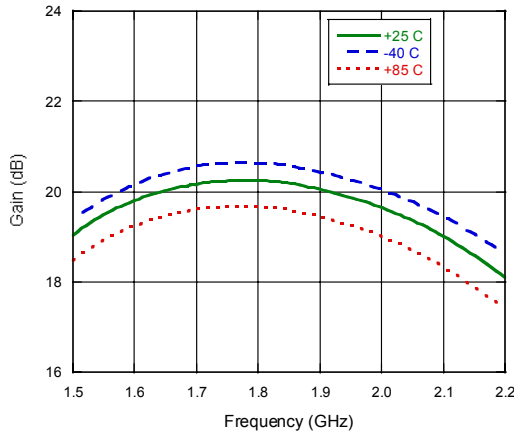

Noise Figure @ 5 V, 8 mA

