

**RF Driver Amplifier
250 - 4000 MHz**

**MAAMSS0057
V2**

Features

- Broadband Operation
- Output Intercept Point Greater than +45 dBm
- Excellent ACPR performance
- High Efficiency
- Lead-Free SOIC-8EP Package
- 100% Matte Tin Plating over Copper
- Halogen-Free "Green" Mold Compound
- RoHS* Compliant and 260°C Reflow Compatible

Description

M/A-COM's MAAMSS0057 RF driver amplifier is a two stage GaAs MMIC which exhibits exceptional linearity performance as well as featuring high gain in a lead-free SOIC-8EP surface mount plastic package. The device runs off a single +5 volt supply and draws 490 mA typically.

The MAAMSS0057 is fabricated using a high reliability GaAs HBT process to realize low current and high power functionality. The process features full passivation for increased performance and reliability.

The MAAMSS0057 has been designed to be a functional driver amplifier from 250 to 4000 MHz.

Ordering Information ¹

Part Number	Package
MAAMSS0057	Bulk Packaging
MAAMSS0057TR-3000	3000 piece reel
MAAMSS0057SMB	2140 MHz Configuration
MAAM-000057-000SMB	Sample Only, General Frequency

1. Reference Application Note M513 for reel size information.

Absolute Maximum Ratings ^{2,3}

Parameter	Absolute Maximum
RF Output Power	32 dBm
Voltage	6 volts
Storage Temperature	-65°C to +150°C
Junction Temperature	200°C

- Exceeding any one or combination of these limits may cause permanent damage to this device.
- M/A-COM does not recommend sustained operation near these survivability limits.

* Restrictions on Hazardous Substances, European Union Directive 2002/95/EC.

Functional Block Diagram

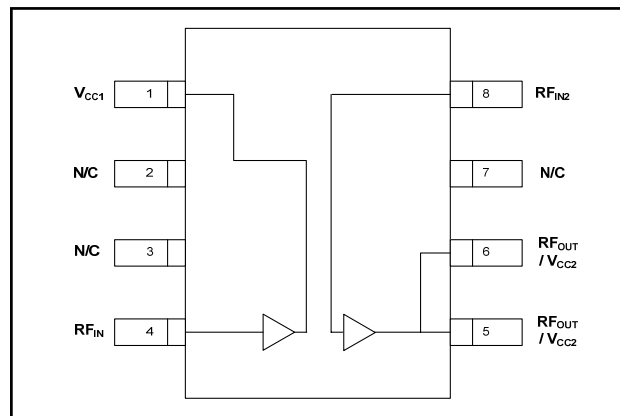

Pin Configuration ⁴

Pin No.	Pin Name	Description
1	V _{CC1}	1st Stage V _{CC} & RF Output
2	N/C	No Connection
3	N/C	No Connection
4	RF _{IN}	Amplifier Input
5	RF _{OUT} / V _{CC2}	Amplifier Output & 2nd Stage V _{CC}
6	RF _{OUT} / V _{CC2}	Amplifier Output & 2nd Stage V _{CC}
7	N/C	No Connection
8	RF _{IN2}	2nd Stage RF Input

4. The exposed pad centered on the package bottom must be connected to the RF and DC ground.

Maximum Operating Conditions ⁵

Parameter	Maximum Operating Conditions
Junction Temperature ⁶	160°C
RF Output Power	32 dBm
Operating Temperature	-40°C to +85°C

- Operating at or within these conditions will ensure MTTF > 1 x 10⁶ hours.
- Typical thermal resistance (θ_{jc}) = 35°C/W.

**RF Driver Amplifier
250 - 4000 MHz**

**MAAMSS0057
V2**

Electrical Specifications: $T_A = 25^\circ\text{C}$, $Z_0 = 50 \Omega$, $V_{CC} = 5\text{V}$

Parameter	Test Conditions	Units	Min.	Typ.	Max.
Gain	2140 MHz	dB	19	21	—
Input Return Loss	2140 MHz	dB	—	-10	—
Output Return Loss	2140 MHz	dB	—	-8	—
Output P1dB	2140 MHz	dBm	—	31	—
Output IP3	(+22 dBm / tone, 1 MHz spacing) 2140 MHz	dBm	42	45	—
Channel Power	(@ -45 dBc ACPR, WCDMA 64 channels fwd) 2140 MHz	dBm	—	24	—
Noise Figure	2140 MHz	dB	—	4.5	—
Quiescent Current	+5V	mA	—	490	—
Current @ 22 dBm Output	(+22 dBm / tone, 1 MHz spacing) 2140 MHz	mA	—	600	750

Lead-Free SOIC-8EP[†]

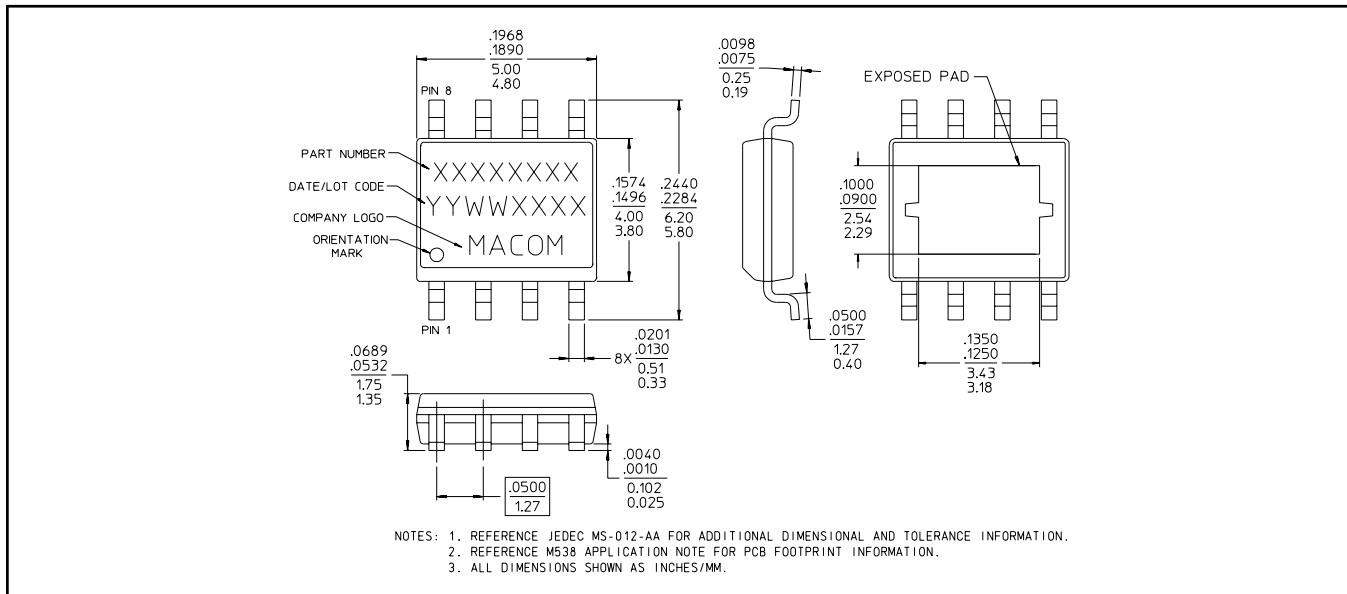

[†] Reference Application Note M538 for lead-free solder reflow recommendations.
Meets JEDEC moisture sensitivity level 1 requirements.

**RF Driver Amplifier
250 - 4000 MHz**

**MAAMSS0057
V2**

2140 MHz PCB Layout

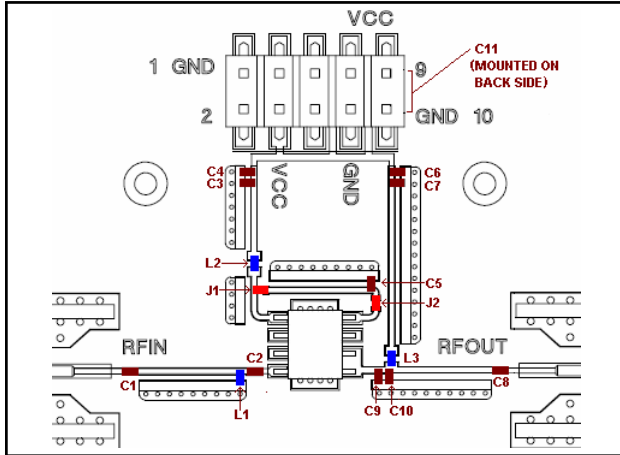

2140 MHz Schematic

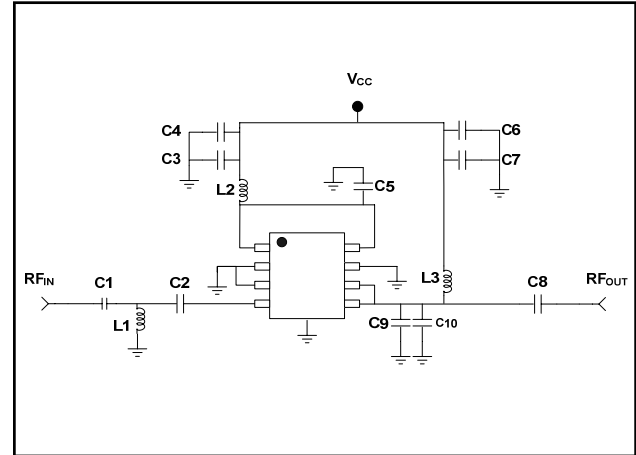

Parts List

Part	Value	Case Style	Manufacturer	Purpose
C1	1000 pF	0402	Murata	DC Block
C2	1.5 pF	0402	Murata	Input Tuning
C3	1000 pF	0402	Murata	Bypass
C4	0.1 μ F	0402	Murata	Bypass
C5	1.5 pF	0402	Murata	Inter-stage Tuning
C6	0.1 μ F	0402	Murata	Bypass
C7	1000 pF	0402	Murata	Bypass
C8	1000 pF	0402	Murata	Output Tuning
C9	1.2 pF	0402	Murata	Inter-stage Tuning
C10	1.2 pF	0402	Murata	Inter-stage Tuning
C11	3.3 μ F	1206	Murata	Bypass
L1	2.7 nH	0402	Coilcraft	Input Tuning
L2	7.5 nH	0402	Coilcraft	Bias Injection
L3	8.2 nH	0402	Coilcraft	Bias Injection
J1	Jumper	-	-	Jumper
J2	Jumper	-	-	Jumper

Cross Section View

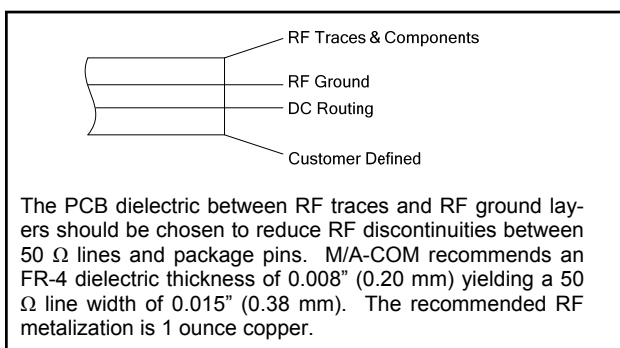

Handling Procedures

Please observe the following precautions to avoid damage:

Static Sensitivity

Gallium Arsenide Integrated Circuits are sensitive to electrostatic discharge (ESD) and can be damaged by static electricity. Proper ESD control techniques should be used when handling these devices.

- **North America** Tel: 800.366.2266 / Fax: 978.366.2266
- **Europe** Tel: 44.1908.574.200 / Fax: 44.1908.574.300
- **Asia/Pacific** Tel: 81.44.844.8296 / Fax: 81.44.844.8298

Visit www.macom.com for additional data sheets and product information.

Typical Performance Curves: 2140 MHz Configuration over temperature

Gain

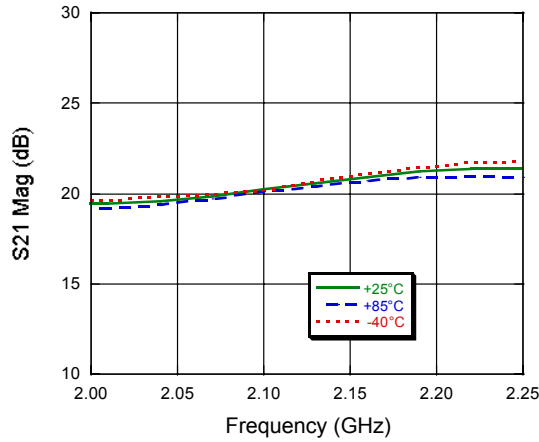

S11

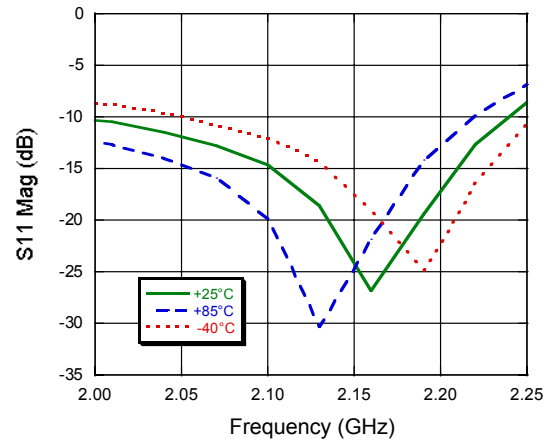

S22

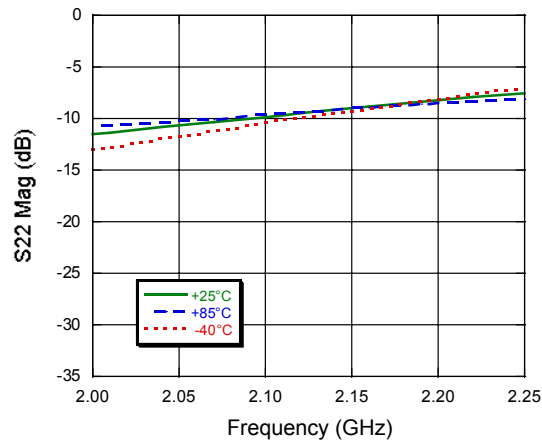

Noise Figure

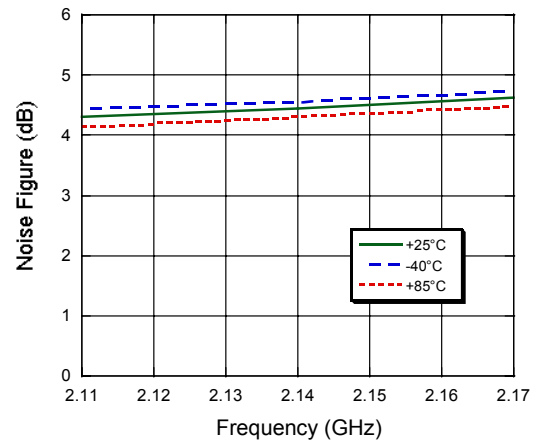

P1dB

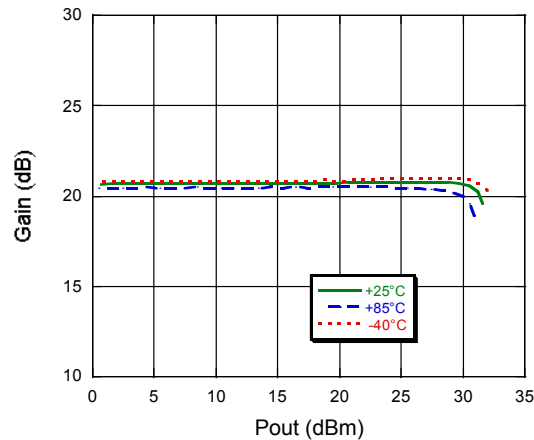

Output IP3

