

VOLTAGE DETECTOR IC with counter timer

BD45XXXG BD46XXXG

BD45XXXG and BD46XXXG are series of high-accuracy detection voltage and low current consumption VOLTAGE DETECTOR ICs adopting CMOS process. New lineup of 156 types with delay time circuit have developed. Delay time is fixed in the IC due to the built-in counter timer to require no external capacitor. Total 156 types of VOLTAGE DETECTOR ICs including BD45XXXG series (Nch open drain output) and BD46XXXG series (CMOS output), each of which has 26 kinds in every 0.1V step (2.3~4.8V) and three kinds of delay time (50msec, 100msec, 200msec) have developed.

● Applications

Every kind of appliances with microcontroller and logic circuit

● Features

- 1) Built-in delay time circuit
(Fixed delay time by the built-in $\pm 10\%$ of high-accuracy counter timer)
- 2) No external capacitor for setting delay time required
- 3) 3 kinds of delay time: 50msec(Typ.)(BD45XX5G,BD46XX5G)
100msec(Typ.)(BD45XX1G,BD46XX1G)
200msec(Typ.)(BD45XX2G,BD46XX2G)
- 4) Detection voltage: 2.3V ~ 4.8V 0.1V step
- 5) High-accuracy detection voltage: $\pm 1.0\%$
- 6) Ultra low current consumption: $0.85\mu\text{A}$ typ.
- 7) Output circuit: Nch open drain(BD45XXXG)
CMOS(BD46XXXG)
- 8) Package: SSOP5(SMP5C2)
- 9) Operating temperature range: $-40^\circ\text{C} \sim +105^\circ\text{C}$

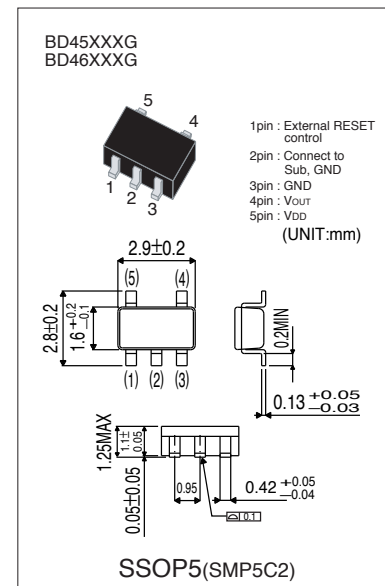

● Application Circuit

BD45XXXG

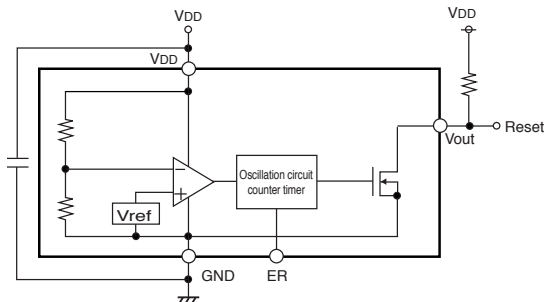

BD46XXXG

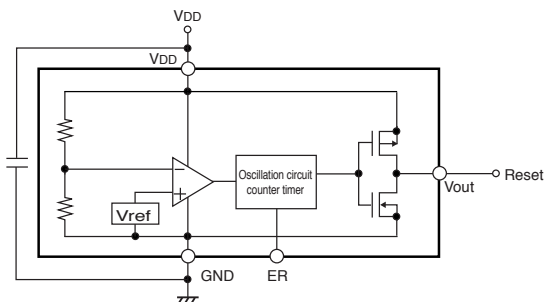

Pin No.	1	2	3	4	5
SSOP5	ER	Sub	GND	V _{OUT}	V _{DD}

Voltage detectors

Absolute Maximum Ratings (Ta=25°C)

Parameter	Symbol	Limits	Unit
Power supply voltage	VDD - GND	- 0.3 ~ + 10	V
Output voltage	Nch open drain output	GND - 0.3 ~ + 10	V
	CMOS output	GND - 0.3 ~ VDD + 0.3	
ER pin input voltage	VCT	GND - 0.3 ~ VDD + 0.3	V
Power dissipation:SSOP5 *1	Pd	540	mW
Operating temperature range	Topr	- 40 ~ + 105	°C
Storage temperature range	Tstg	- 55 ~ + 125	°C

*1 Derating: 5.4mW/°C for operation above Ta=25°C.(Mounted on a 70.0mmX70.0mmX16mm glass epoxy PCB.)

Electrical characteristics (Unless otherwise noted; Ta=-25°C ~ +105°C)

Parameter	Symbol	Min.	Typ.	Max.	Unit	Conditions
Detection voltage temperature coefficient *1	VDET/ΔT	—	±100	±360	ppm/°C	Ta=-40°C ~ +105°C
Hysteresis voltage	ΔVDET	VDET×0.03	VDET×0.05	VDET×0.08	%	RL=470kΩ, VDD=L→H→L
Circuit current when ON *1	Icc1	—	0.70	2.10	μA	VDD=VDET-0.2V
		—	0.75	2.25		
		—	0.80	2.40		
Circuit current when OFF *1	Icc2	—	0.75	2.25	μA	VDD=VDET+2V
		—	0.80	2.40		
		—	0.85	2.55		
Min. operating voltage	VOPL	0.95	—	—	V	RL=470kΩ, VOL≥0.4V
"L" output current	IOL	0.4	1.2	—	mA	VDS=0.5V, VDD=1.2V
		2.0	5	—		VDS=0.5V, VDD=2.4V (VDET≥2.7V)
"H" output current *1	IOH	1.0	2.2	—	mA	VDS=0.5V, VDD=4.8V VDET=2.3~4.2V
		1.2	2.7	—		VDS=0.5V, VDD=6.0V VDET=4.3~4.8V
Output leak current *1	Ilaek	—	—	0.1	μA	VDD=VDS=10V
"H" transmission delay time *1	tPLH	45	50	55	V	RL=100kΩ CL=100pF
		90	100	110		
		180	200	220		
ER pin "H" voltage *1	VEH	2.0	—	—	V	
ER pin "L" voltage *1	VEL	—	—	0.8	V	
ER pin input current	IER	—	1	10	μA	VER=2.0V

*1 This value is guaranteed at Ta=25°C.
Note) RL is not necessary for CMOS output type.
Note) Please refer to the detection voltage of Line-up table.

Characteristic diagram and Measurement circuit

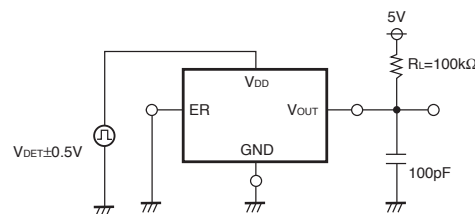
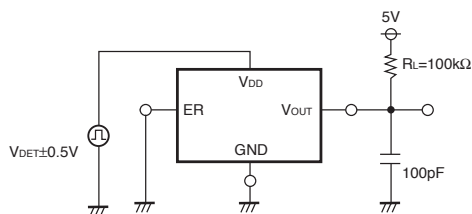
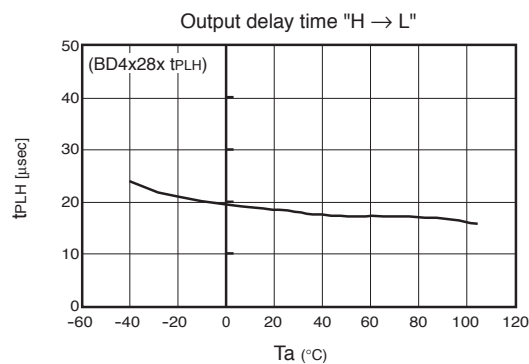
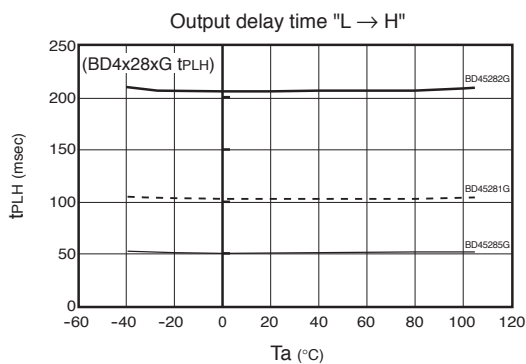

Circuit current

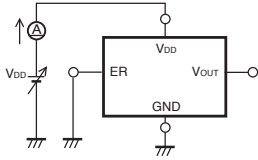
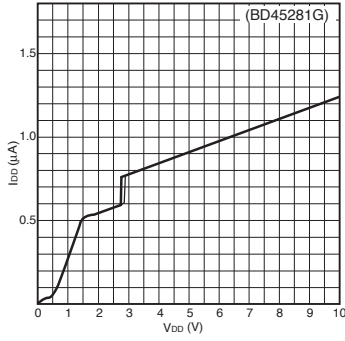

"L" output current

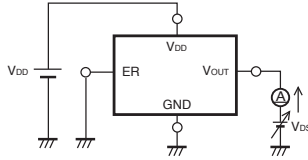
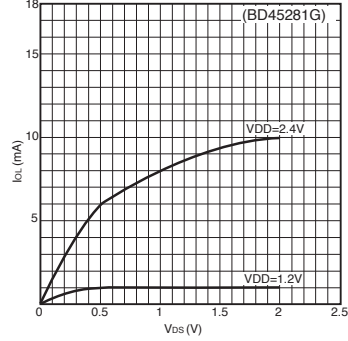

"H" output current

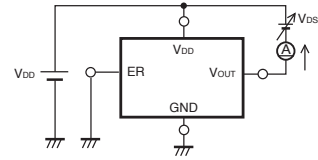
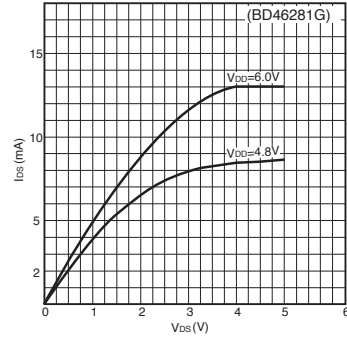

I/O characteristic

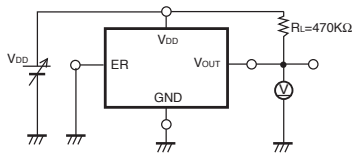
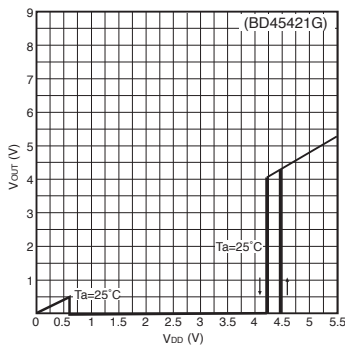

Detection voltage

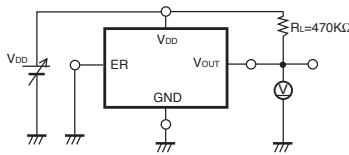
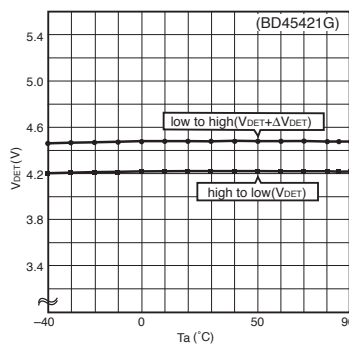

● Timing waveform

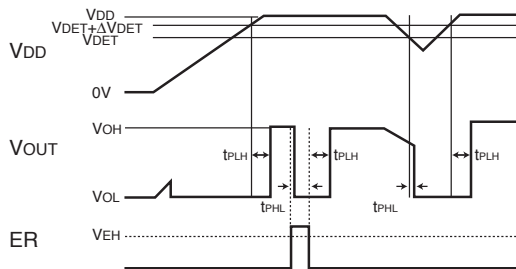

● Part number and Marking of samples

Voltage	Marking	Part No.	Marking	Part No.	Marking	Part No.	Marking	Part No.	Marking	Part No.	Marking	Part No.
4.8V	T0	BD45485	TS	BD45481	UJ	BD45482	VA	BD46485	W2	BD46481	WU	BD46482
4.7V	T1	BD45475	TT	BD45471	UK	BD45472	VB	BD46475	W3	BD46471	WV	BD46472
4.6V	T2	BD45465	TU	BD45461	UL	BD45462	VC	BD46465	W4	BD46461	WW	BD46462
4.5V	T3	BD45455	TV	BD45451	UM	BD45452	VD	BD46455	W5	BD46451	WX	BD46452
4.4V	T4	BD45445	TW	BD45441	UN	BD45442	VE	BD46445	W6	BD46441	WY	BD46442
4.3V	T5	BD45435	TX	BD45431	UP	BD45432	VF	BD46435	W7	BD46431	WZ	BD46432
4.2V	T6	BD45425	TY	BD45421	UQ	BD45422	VG	BD46425	W8	BD46421	X0	BD46422
4.1V	T7	BD45415	TZ	BD45411	UR	BD45412	VH	BD46415	W9	BD46411	X1	BD46412
4.0V	T8	BD45405	U0	BD45401	US	BD45402	VJ	BD46405	WA	BD46401	X2	BD46402
3.9V	T9	BD45395	U1	BD45391	UT	BD45392	VK	BD46395	WB	BD46391	X3	BD46392
3.8V	TA	BD45385	U2	BD45381	UU	BD45382	VL	BD46385	WC	BD46381	X4	BD46382
3.7V	TB	BD45375	U3	BD45371	UV	BD45372	VM	BD46375	WD	BD46371	X5	BD46372
3.6V	TC	BD45365	U4	BD45361	UW	BD45362	VN	BD46365	WE	BD46361	X6	BD46362
3.5V	TD	BD45355	U5	BD45351	UX	BD45352	VP	BD46355	WF	BD46351	X7	BD46352
3.4V	TE	BD45345	U6	BD45341	UY	BD45342	VQ	BD46345	WG	BD46341	X8	BD46342
3.3V	TF	BD45335	U7	BD45331	UZ	BD45332	VR	BD46335	WH	BD46331	X9	BD46332
3.2V	TG	BD45325	U8	BD45321	V0	BD45322	VS	BD46325	WJ	BD46321	XA	BD46322
3.1V	TH	BD45315	U9	BD45311	V1	BD45312	VT	BD46315	WK	BD46311	XB	BD46312
3.0V	TJ	BD45305	UA	BD45301	V2	BD45302	VU	BD46305	WL	BD46301	XC	BD46302
2.9V	TK	BD45295	UB	BD45291	V3	BD45292	VV	BD46295	WM	BD46291	XD	BD46292
2.8V	TL	BD45285	UC	BD45281	V4	BD45282	VW	BD46285	WN	BD46281	XE	BD46282
2.7V	TM	BD45275	UD	BD45271	V5	BD45272	VX	BD46275	WP	BD46271	XF	BD46272
2.6V	TN	BD45265	UE	BD45261	V6	BD45262	VY	BD46265	WQ	BD46261	XG	BD46262
2.5V	TP	BD45255	UF	BD45251	V7	BD45252	VZ	BD46255	WR	BD46251	XH	BD46252
2.4V	TQ	BD45245	UG	BD45241	V8	BD45242	W0	BD46245	WS	BD46241	XJ	BD46242
2.3V	TR	BD45235	UH	BD45231	V9	BD45232	W1	BD46235	WT	BD46231	XK	BD46232

BD45XXXG/BD46XXXG : SSOP5(SMP5C2)

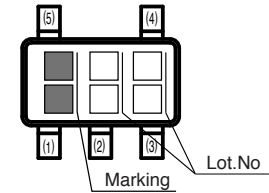

● Line-up

Detection voltage V _{DET}	50msec delay		100msec delay		200msec delay		Detection voltage V _{DET} (V) Ta=25°C			Hysteresis voltage (V, Typ.)	Package
	Nch open drain output	CMOS output	Nch open drain output	CMOS output	Nch open drain output	CMOS output	Min.	Typ.	Max.		
							4.8V	BD45485G	BD46485G		
4.7V	BD45475G	BD46475G	BD45471G	BD46471G	BD45472G	BD46472G	4.653	4.700	4.747		
4.6V	BD45465G	BD46465G	BD45461G	BD46461G	BD45462G	BD46462G	4.554	4.600	4.646		
4.5V	BD45455G	BD46455G	BD45451G	BD46451G	BD45452G	BD46452G	4.455	4.500	4.545		
4.4V	BD45445G	BD46445G	BD45441G	BD46441G	BD45442G	BD46442G	4.356	4.400	4.444		
4.3V	BD45435G	BD46435G	BD45431G	BD46431G	BD45432G	BD46432G	4.257	4.300	4.343		
4.2V	BD45425G	BD46425G	BD45421G	BD46421G	BD45422G	BD46422G	4.158	4.200	4.242		
4.1V	BD45415G	BD46415G	BD45411G	BD46411G	BD45412G	BD46412G	4.059	4.100	4.141		
4.0V	BD45405G	BD46405G	BD45401G	BD46401G	BD45402G	BD46402G	3.960	4.000	4.040		
3.9V	BD45395G	BD46395G	BD45391G	BD46391G	BD45392G	BD46392G	3.861	3.900	3.939		
3.8V	BD45385G	BD46385G	BD45381G	BD46381G	BD45382G	BD46382G	3.762	3.800	3.838		
3.7V	BD45375G	BD46375G	BD45371G	BD46371G	BD45372G	BD46372G	3.663	3.700	3.737		
3.6V	BD45365G	BD46365G	BD45361G	BD46361G	BD45362G	BD46362G	3.564	3.600	3.636		
3.5V	BD45355G	BD46355G	BD45351G	BD46351G	BD45352G	BD46352G	3.465	3.500	3.535		
3.4V	BD45345G	BD46345G	BD45341G	BD46341G	BD45342G	BD46342G	3.366	3.400	3.434		
3.3V	BD45335G	BD46335G	BD45331G	BD46331G	BD45332G	BD46332G	3.267	3.300	3.333		
3.2V	BD45325G	BD46325G	BD45321G	BD46321G	BD45322G	BD46322G	3.168	3.200	3.232		
3.1V	BD45315G	BD46315G	BD45311G	BD46311G	BD45312G	BD46312G	3.069	3.100	3.131		
3.0V	BD45305G	BD46305G	BD45301G	BD46301G	BD45302G	BD46302G	2.970	3.000	3.030		
2.9V	BD45295G	BD46295G	BD45291G	BD46291G	BD45292G	BD46292G	2.871	2.900	2.929		
2.8V	BD45285G	BD46285G	BD45281G	BD46281G	BD45282G	BD46282G	2.772	2.800	2.828		
2.7V	BD45275G	BD46275G	BD45271G	BD46271G	BD45272G	BD46272G	2.673	2.700	2.727		
2.6V	BD45265G	BD46265G	BD45261G	BD46261G	BD45262G	BD46262G	2.574	2.600	2.626		
2.5V	BD45255G	BD46255G	BD45251G	BD46251G	BD45252G	BD46252G	2.475	2.500	2.525		
2.4V	BD45245G	BD46245G	BD45241G	BD46241G	BD45242G	BD46242G	2.376	2.400	2.424		
2.3V	BD45235G	BD46235G	BD45231G	BD46231G	BD45232G	BD46232G	2.277	2.300	2.323		