

TOSHIBA BIPOLAR LINEAR INTEGRATED CIRCUIT SILICON MONOLITHIC

TA2029FN, TA2029F, TA2029N

FM F/E + AM / FM IF + PW IC FOR DIGITAL TUNING SYSTEM

The TA2029FN/F/N are AM/FM single chip radio system ICs which are designed for Monaural Radio.

These ICs have many functions and can be used for Digital Tuning System.

FEATURES

- Built-in FM F/E, AM/FM IF, electronic volume and power amplifier.
- Suitable for combination with digital tuning system which has IF counter.
 - AM/FM IF output for IF counter.
 - FM : 1.3375MHz (1/8 IF)
 - AM : 450kHz
 - AM/FM oscillation buffer outputs.
 - Auto stop sensitivity at the searching mode is adjustable by external resistances. (Pin⑤, Pin⑥)
- Adjustment-free type FM detector.
- Built-in AF power amplifier, electronic volume and audio muting circuits.
- Detector outputs FM/AM are independent each other.
- $P_O = 100\text{mW}$ (Typ.), THD = 10% (FN/F : 3V/8 Ω)
- $P_O = 500\text{mW}$ (Typ.), THD = 10% (N : 6V/8 Ω)
- Operating supply voltage range
 - : $V_{CC} = 1.8\sim 8\text{V}$ ($T_a = 25^\circ\text{C}$)

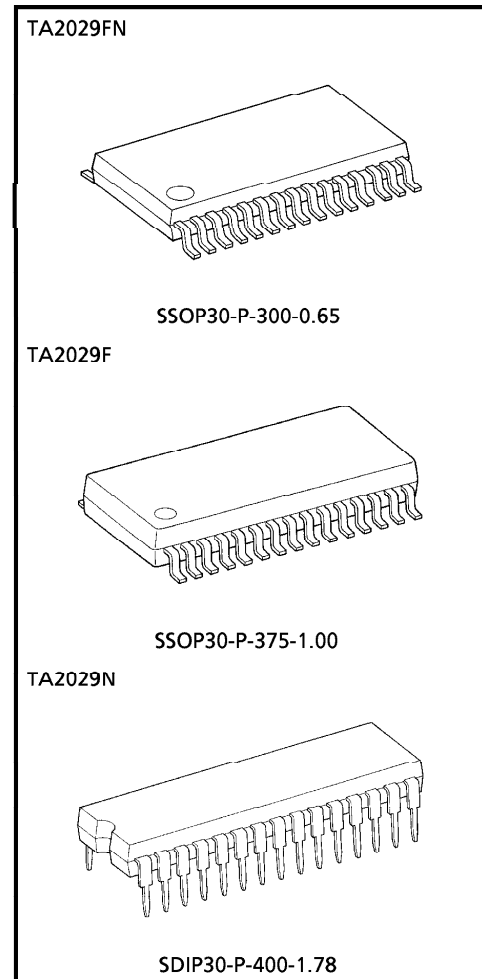

Weight	
SSOP30-P-300-0.65	: 0.17g (Typ.)
SSOP30-P-375-1.00	: 0.7g (Typ.)
SDIP30-P-400-1.78	: 2.2g (Typ.)

961001EBA2

- TOSHIBA is continually working to improve the quality and the reliability of its products. Nevertheless, semiconductor devices in general can malfunction or fail due to their inherent electrical sensitivity and vulnerability to physical stress. It is the responsibility of the buyer, when utilizing TOSHIBA products, to observe standards of safety, and to avoid situations in which a malfunction or failure of a TOSHIBA product could cause loss of human life, bodily injury or damage to property. In developing your designs, please ensure that TOSHIBA products are used within specified operating ranges as set forth in the most recent products specifications. Also, please keep in mind the precautions and conditions set forth in the TOSHIBA Semiconductor Reliability Handbook.
- The products described in this document are subject to foreign exchange and foreign trade control laws.
- The information contained herein is presented only as a guide for the applications of our products. No responsibility is assumed by TOSHIBA CORPORATION for any infringements of intellectual property or other rights of the third parties which may result from its use. No license is granted by implication or otherwise under any intellectual property or other rights of TOSHIBA CORPORATION or others.
- The information contained herein is subject to change without notice.

BLOCK DIAGRAM

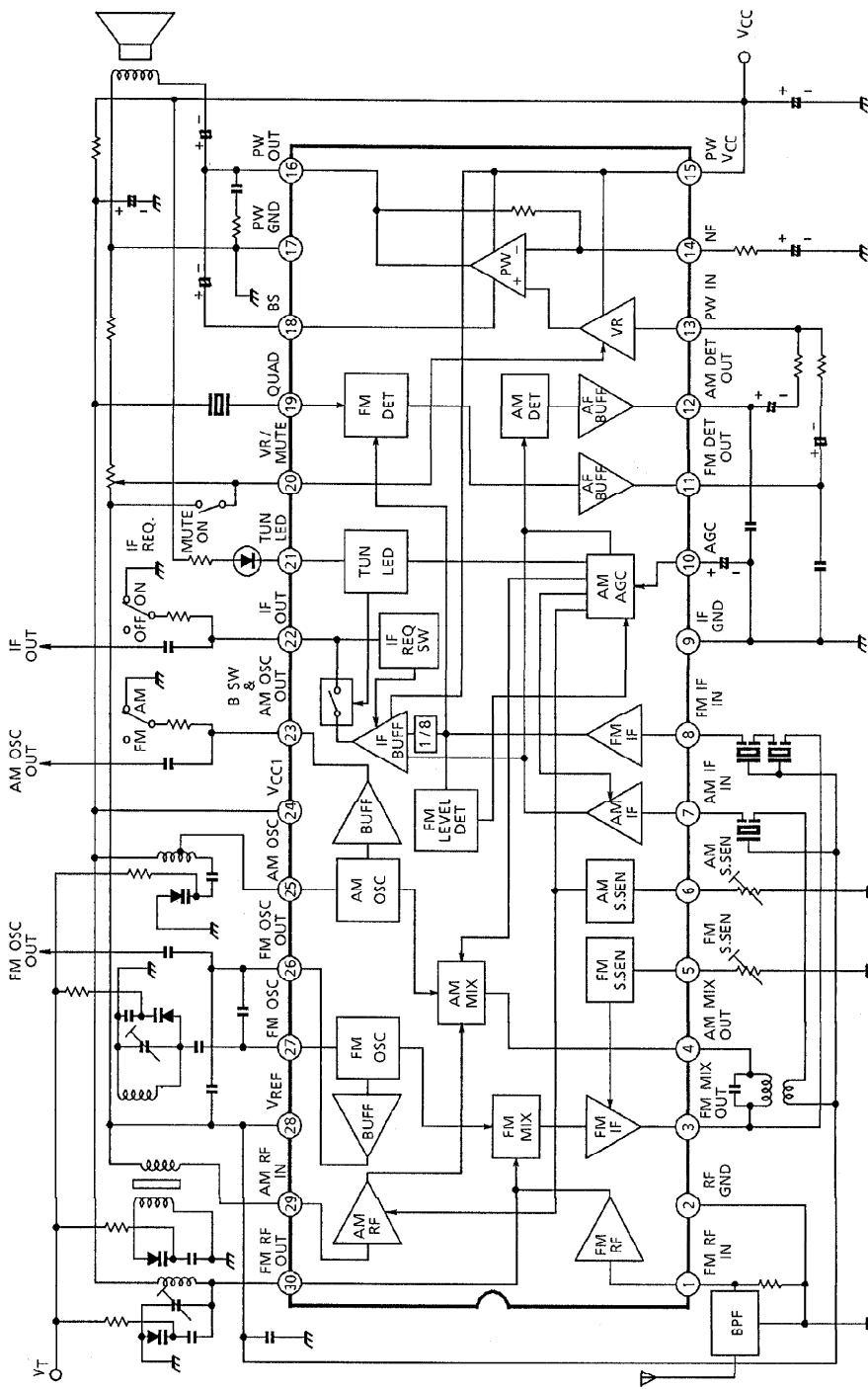

TA2029FN /F/N -2

EXPLANATION OF TERMINALS (Note : Ta = 25°C, V_{CC} = 3V, at no signal)

PIN No.	CHARACTERISTIC	INTERNAL CIRCUIT	DC VOLTAGE (V) (Typ.)	
			AM	FM
1	FM RF IN FM RF input terminal		0	0.7
2	RF GND (GND of RF stage)	—	0	0
3	FM MIX OUT Ceramic filter is connected. Recommendation SFE10.7MA5L (MURATA MFG. CO., LTD)		2.3	1.8
4	AM MIX OUT		2.3	1.8
5	FM S.SEN Adjustable for FM IF output Sensitivity by external resistor.		0	0.3
6	AM S.SEN Adjustable for AM IF output Sensitivity by external resistor.		0.3	0

PIN No.	CHARACTERISTIC	INTERNAL CIRCUIT	DC VOLTAGE (V) (Typ.)	
			AM	FM
7	AM IF IN		1.22	1.2
8	FM IF IN		3.0	3.0
9	IF GND (GND of AM/FM IF)	—	0	0
10	AGC (AM AGC) Capacitor is connected.		0	0
11	FM DET OUT FM detector output terminal.		—	1.2
12	AM DET OUT AM detector output terminal.		0.5	1.2

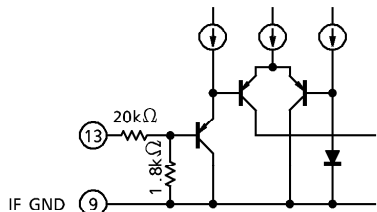
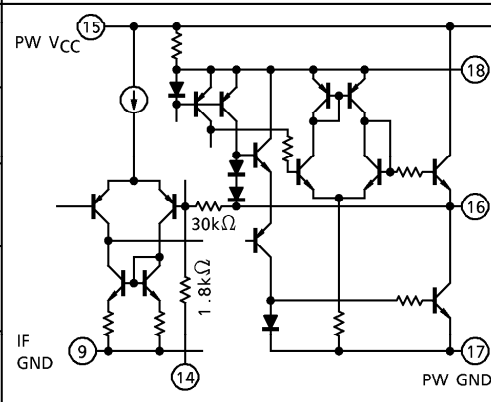
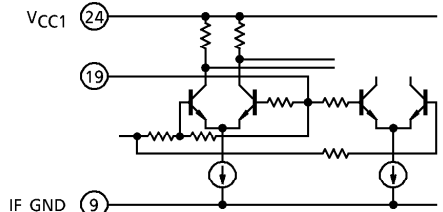
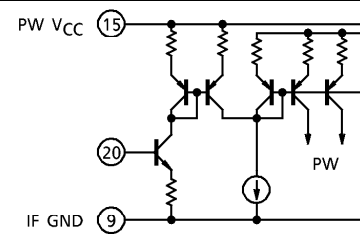
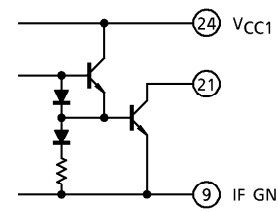
PIN No.	CHARACTERISTIC	INTERNAL CIRCUIT	DC VOLTAGE (V) (Typ.)	
			AM	FM
13	PW IN		0	0
14	NF Capacitor is connected.		0.8	0.8
15	PW VCC (VCC of PW and Buffer amplifier for IF Counter.)		3.0	3.0
16	PW OUT		1.6	1.6
17	PW GND (GND of PW)		0	0
18	BS Capacitor is connected.		3.0	3.0
19	QUAD FM QUAD Detector Ceramic discriminator is connected Recommendation CDA10.7MG36. (MURATA MFG. CO., LTD)		2.5	2.3
20	MUTE / VR ● Variable resistor for electronic volume control is connected. ● Mute terminal V ₂₀ : V _{ref} → MUTE ON		—	—
21	TUN LED		—	—

PIN No.	CHARACTERISTIC	INTERNAL CIRCUIT	DC VOLTAGE (V) (Typ.)	
			AM	FM
22	<p>IF OUT</p> <p>IF output terminal</p> <p>Pin⑳ connects with GND by resistor→Come out</p> <p>Pin㉑ : OPEN→Non output</p>		2.5	2.5
23	<p>AM OSC OUT / BAND SW</p> <p>AM Oscillation Buffer Output Terminal.</p> <p>Bias Terminal for AM / FM Switch Circuit.</p> <p>Pin㉓ connects with GND by resistor→AM MODE</p> <p>Pin㉓ : OPEN→FM MODE</p>		1.7	2.5
24	VCC1 (VCC of RF stage)	—	3.0	3.0
25	<p>AM OSC</p> <p>AM OSC Tank circuit is connected.</p>		3.0	3.0
26	<p>FM OSC OUT</p> <p>Capacitor is connected between Pin ㉖ and Pin ㉗ shown in the right figure.</p>		0.7	0.5
27	<p>FM OSC</p> <p>FM OSC Tank circuit is connected shown in the right figure.</p>		1.22	1.15
28	<p>V_{ref}</p> <p>Regulator voltage output terminal</p> <p>V_{ref} = 1.2V (Typ.) : FM MODE</p> <p>1.22V (Typ.) : AM MODE</p>		1.22	1.2

PIN No.	CHARACTERISTIC	INTERNAL CIRCUIT	DC VOLTAGE (V) (Typ.)	
			AM	FM
29	AM RF IN AM RF input terminal.		1.22	1.2
30	FM RF OUT FM RF Tank circuit is connected.	cf. Pin①	3.0	3.0

MAXIMUM RATINGS (Ta = 25°C)

CHARACTERISTIC	SYMBOL	RATING	UNIT
Supply Voltage	V _{CC}	9	V
Power Dissipation	P _D (Note)	500	mW
		890	
		1500	
Operating Temperature	T _{opr}	- 25~75	°C
Storage Temperature	T _{stg}	- 55~150	°C

Note : Derated above 25°C in the proportion of 4.8mW/°C for TA2029FN, 7.2mW/°C for TA2029F and 12mW/°C for TA2029N.

ELECTRICAL CHARACTERISTICS

Unless otherwise specified, Ta = 25°C, VCC = 3V, SW2 : OFF, SW3 : OFF, SW7 : OFF

F / E : f = 83MHz, fm = 1kHz

FM IF : f = 10.7MHz, Δf = ± 22.5kHz, fm = 1kHz

AM : f = 1005kHz, MOD = 30%, fm = 1kHz

CHARACTERISTIC		SYMBOL	TEST CIRCUIT	TEST CONDITION	MIN.	TYP.	MAX.	UNIT	
Supply Current		ICCQ (FM)	1	FM Mode Power AMP : OFF	—	11.5	16.0	mA	
		ICC (FM)	1	Vin = 0 Power AMP : ON SW2 : ON, SW7 : ON	—	18.0	25.0		
		ICCQ (AM)	1	AM Mode Power AMP : OFF	—	7.5	11.0		
		ICC (AM)	1	Vin = 0 Power AMP : ON SW2 : ON, SW7 : ON	—	17.0	24.0		
F / E	Input Limiting Voltage	Vin (lim)	1	- 3dB Limiting	—	12	—	dB μ V EMF	
	Quiescent Sensitivity	QS		S / N = 30dB	—	15	—	dB μ V EMF	
	Local OSC Stop Voltage	Vstop (FM)	2	Vin = 0	—	1.35	—	V	
	Local OSC Buffer Output Voltage	Vosc (buff)	2	fosc = 108MHz	—	130	—	mVrms	
FM	Input Limiting Voltage	Vin (lim) IF	1	- 3dB Limiting	39	44	49	dB μ V EMF	
	Recovered Output Voltage	VOD	1	Vin = 80dB μ V EMF	55	80	110	mVrms	
	Signal To Noise Ratio	S / N	1	Vin = 80dB μ V EMF	—	70	—	dB	
	Total Harmonic Distortion	THD	1	Vin = 80dB μ V EMF	—	0.4	—	%	
	AM Rejection Ratio	AMR	1	Vin = 80dB μ V EMF	—	48	—	dB	
	LED ON Sensitivity	VL	1	IL = 1mA	40	45	50	dB μ V EMF	
	IF Count Output Frequency	1 / 8 IF	f1 / 8IF (FM)	1	SW2 : ON, Vin = 80dB μ V EMF	1.3373	1.3375	1.3377	MHz
	IF Count Output Voltage	1 / 8 IF	V1 / 8IF (FM)	1	SW2 : ON, Vin = 80dB μ V EMF	110	200	—	mVrms
	IF Count Output Sensitivity		IFSENS (FM)1	1	SW6 : 10k Ω	—	48	—	dB μ V
		IFSENS (FM)2	1	SW6 : 0 Ω	—	68	—	EMF	
Pin① Output Resistance	R11		1	—	—	1	—	k Ω	

CHARACTERISTIC		SYMBOL	TEST CIRCUIT	TEST CONDITION	MIN.	TYP.	MAX.	UNIT
AM	Gain	G _V	1	V _{in} = 26dB μ V EMF	20	45	80	mV _{rms}
	Recovered Output Voltage	V _{OD}	1	V _{in} = 60dB μ V EMF	50	75	100	mV _{rms}
	Signal To Noise Ratio	S/N	1	V _{in} = 60dB μ V EMF	—	42	—	dB
	Total Harmonic Distortion	THD	1	V _{in} = 60dB μ V EMF	—	1.0	—	%
	LED ON Sensitivity	V _L	1	I _L = 1mA	24	29	34	dB μ V EMF
	Local OSC Buff. Output Voltage	V _{osc} (AM)	1	f _{osc} = 1455kHz	80	140	—	mV _{rms}
	IF Count Output Voltage	V _{IF} (AM)	1	SW ₂ : ON, V _{in} = 60dB μ V EMF	110	200	—	mV _{rms}
	IF Count Output Sensitivity	IFSENS(AM)1	1	SW ₅ : 10k Ω	—	29	—	dB μ V
		IFSENS(AM)2		SW ₅ : 0 Ω	—	45	—	EMF
Pin $\text{\textcircled{2}}$ Output Resistance	R ₁₂	1	—	—	5	—	k Ω	
PW	Voltage Gain	G _V	1	f = 1kHz, R _L = 8 Ω , V _O = 0.775V _{rms} , SW ₇ : ON	27	30	33	dB
	Output Power	P _{O1}	1	f = 1kHz, R _L = 8 Ω , THD = 10%, SW ₇ : ON	70	100	—	mW
		P _{O2}	1	V _{CC} = 6V, f = 1kHz, R _L = 8 Ω , THD = 10%, SW ₇ : ON	350	500	—	
	Total Harmonic Distortion	THD	1	f = 1kHz, R _L = 8 Ω , P _O = 50mW, SW ₇ : ON	—	0.6	1.5	%
	Output Noise Voltage	V _{no}	1	R _g = 10k Ω , R _L = 8 Ω , SW ₇ : ON BPF = 30Hz~20kHz	—	0.45	—	mV _{rms}
	Muting Attenuation	ATT	1	V _O = 0.775V _{rms} SW ₃ : OFF→ON, SW ₇ : ON	65	77	—	dB

TEST CIRCUIT 1

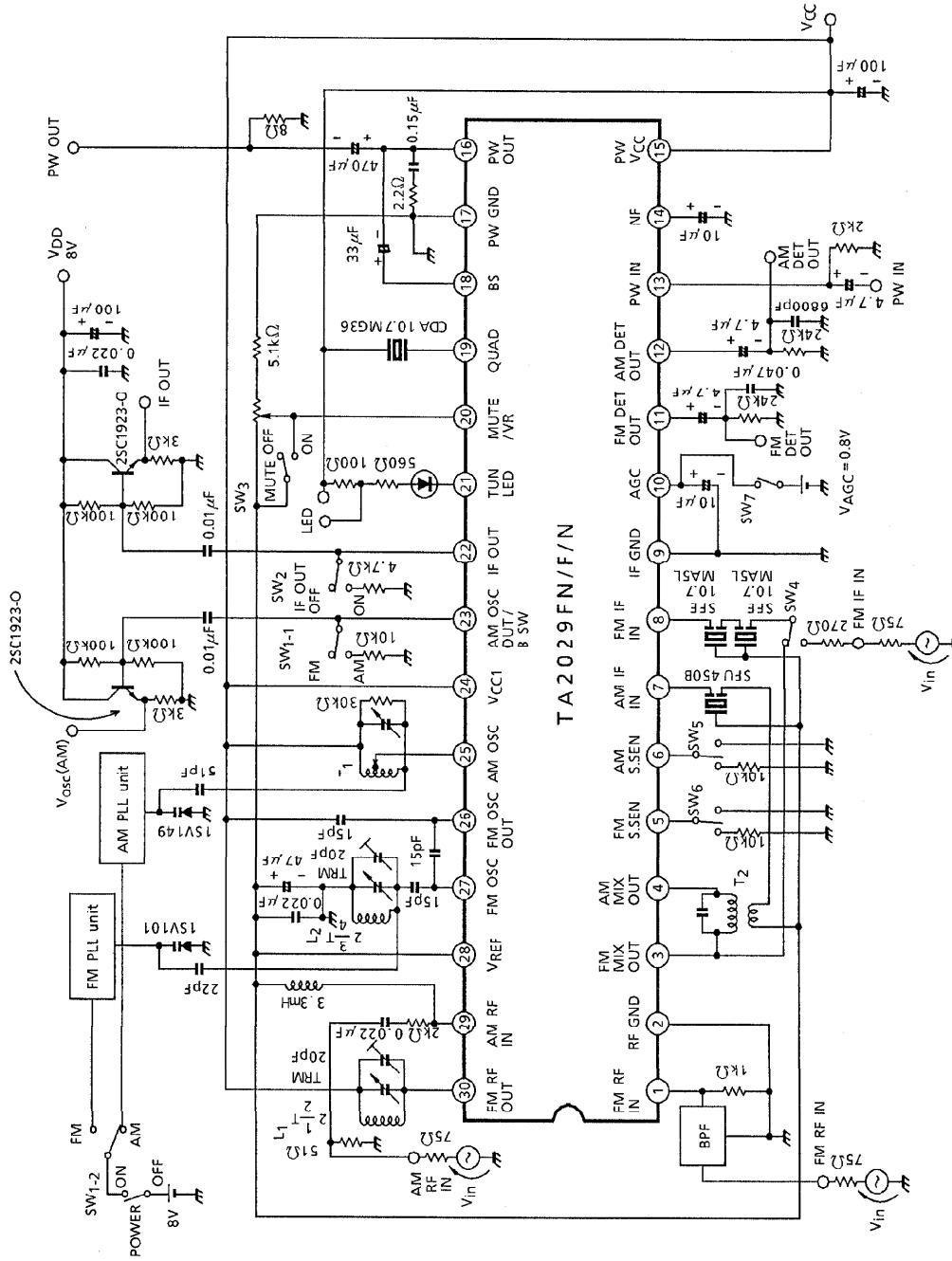

TA2029FN/F/N

TA2029FN /F/N - 10

TEST CIRCUIT 2

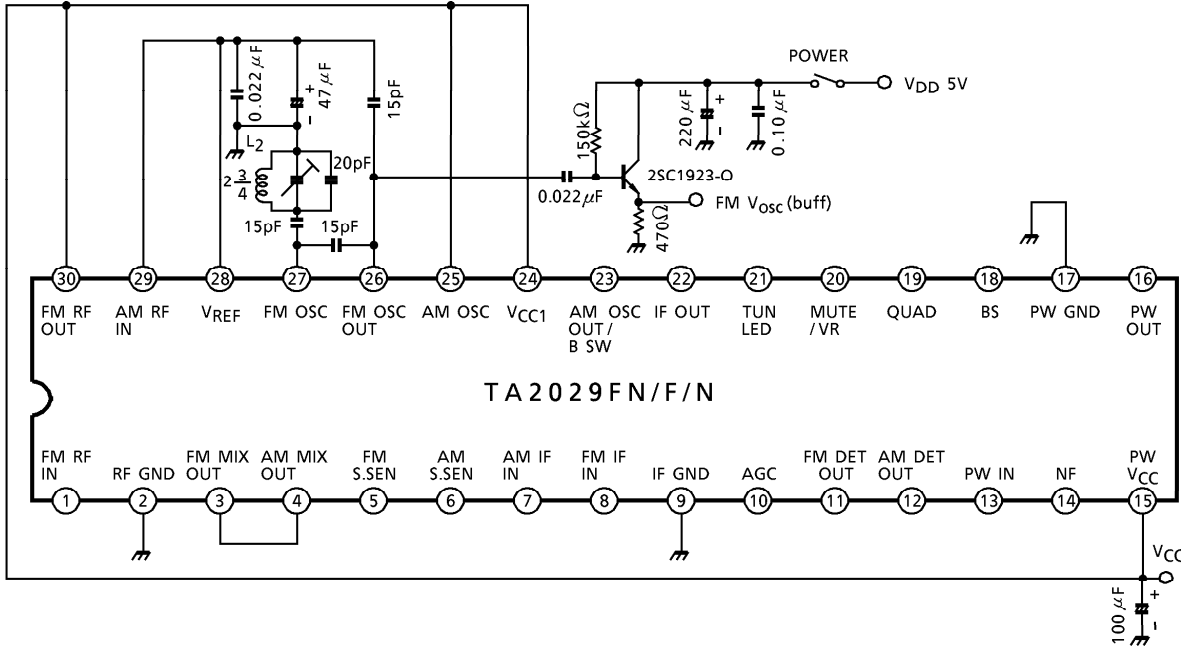

COIL DATA

COIL No.	TEST FREQUENCY	L (μH)	C _o (pF)	Q _o	TURNS					WIRE (mm φ)	REF.
					1-2	2-3	1-3	1-4	4-6		
L ₁ FM RF	100MHz	—	—	100	—	—	—	2 $\frac{1}{2}$	—	0.5UEW	Ⓢ 53T-037-202
L ₂ FM OSC	100MHz	—	—	100	—	—	2 $\frac{3}{4}$	—	—	0.5UEW	Ⓢ 0258-244
T ₁ AM OSC	796kHz	288	—	115	13	73	—	—	—	0.08UEW	Ⓢ 4147-1356-038
T ₂ AM IFT	455kHz	—	180	120	—	—	180	—	15	0.08UEW	Ⓢ 2150-2162-165

Ⓢ SUMIDA ELECTRIC Co., LTD

L₁ : FM RF

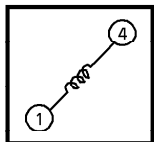

L₂ : FM OSC

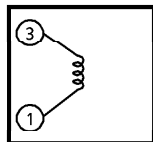

T₁ : AM OSC

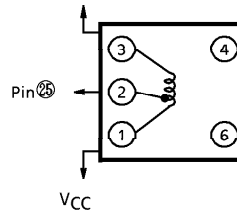

T₂ : AM IFT

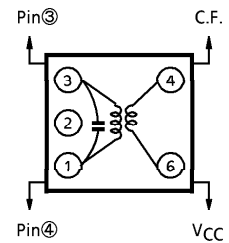

OUTLINE DRAWING
SSOP30-P-300-0.65

Unit : mm

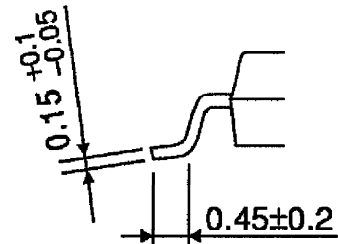
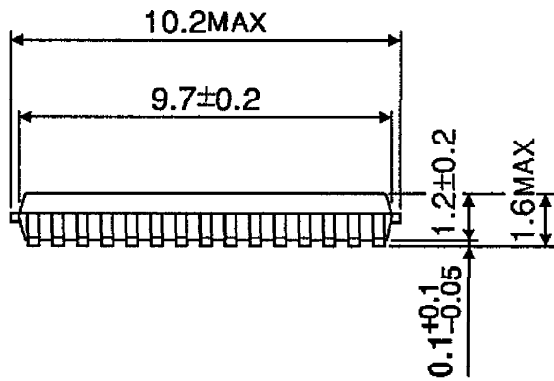
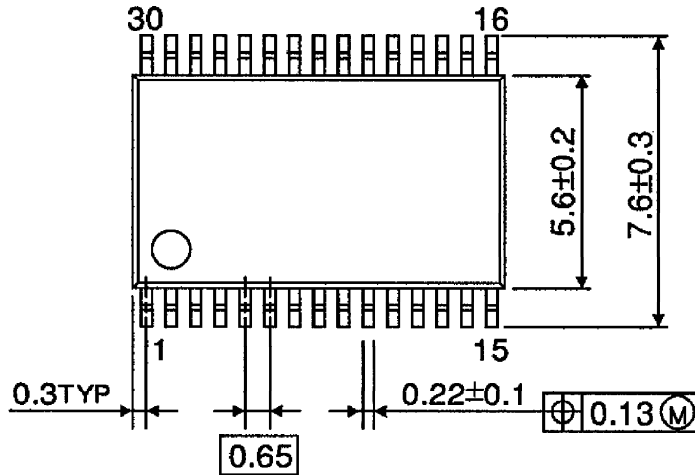

Weight : 0.17g (Typ.)

OUTLINE DRAWING
SSOP30-P-375-1.00

Unit : mm

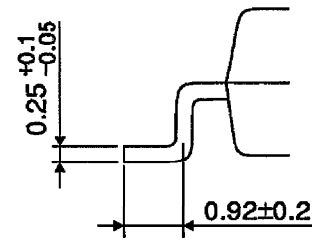
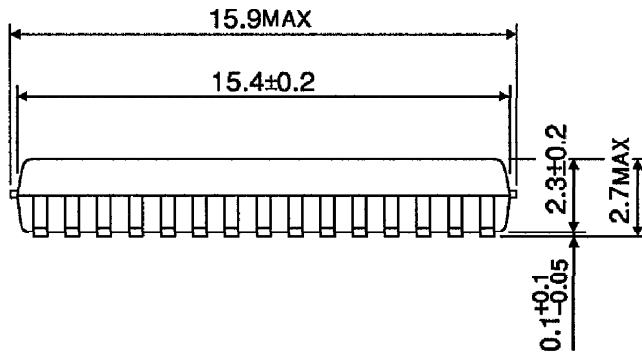
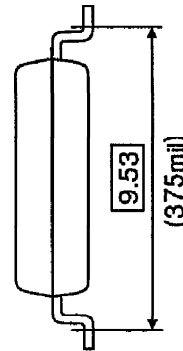
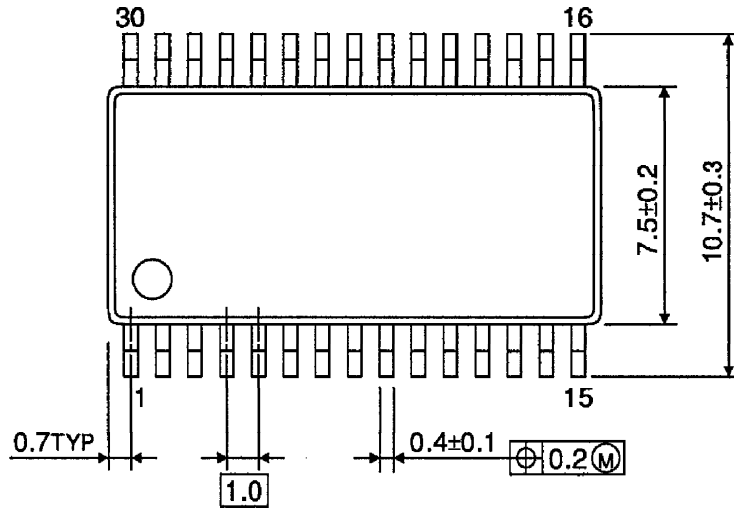

Weight : 0.7g (Typ.)

OUTLINE DRAWING
SDIP30-P-400-1.78

Unit : mm

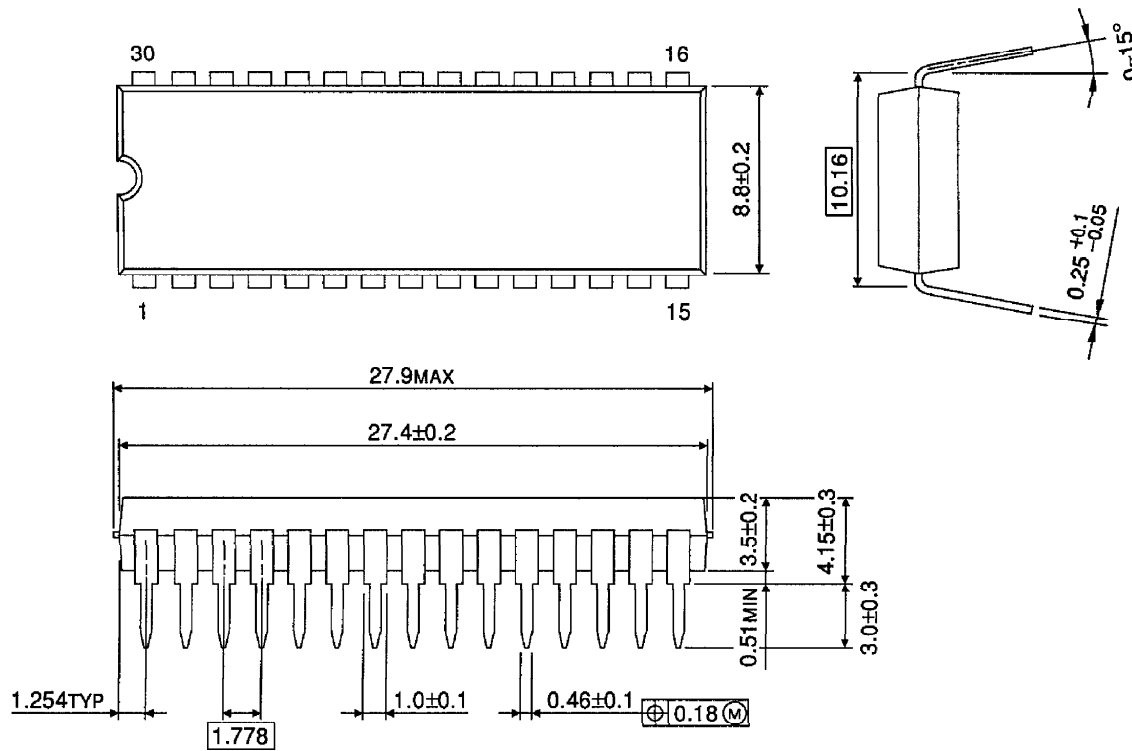

Weight : 2.2g (Typ.)