

RoHS Compliant Product

Description

The S5U1284 is 4A regulator with extremely low dropout voltage. This product is specifically designed to provide well regulated supply for applications requiring 2.8V or lower voltages from 3.3V ATX power supplies where high efficiency of the switch can be achieved without the cost and complexity associated with switching regulator. One such application is the new graphic chipsets that requires anywhere from 2.4V to 2.7V supply.

Features

- * 0.7V Max. Dropout Voltage At 4A Load Current
- * Adjustable or Fixed Output Voltage 1.5V, 1.8V, 2.5V, 3.3V, 5.0V
- * Output Current Limiting
- * Good Noise Rejection
- * Fast Transient Response
- * Built-in Thermal Shutdown

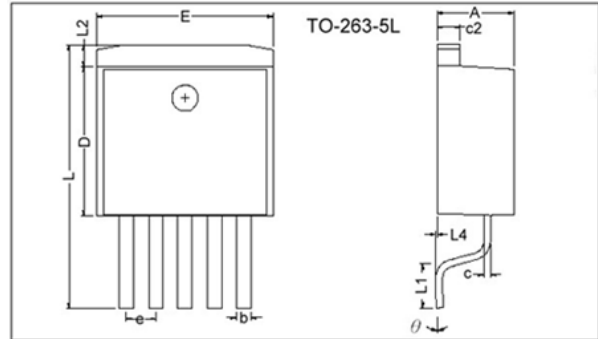

REF.	Millimeter		REF.	Millimeter	
	Min.	Max.		Min.	Max.
A	4.40	4.80	c2	1.25	1.45
b	0.66	0.91	L2	1.27	REF.
L4	0.00	0.30		8.6	9.0
c	0.36	0.5	e	1.70	REF.
L1	2.29	2.79	L	14.6	15.8
E	9.80	10.4	theta	0°	8°

Typical Circuit

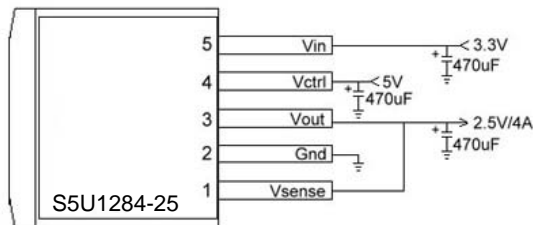

Block Diagram

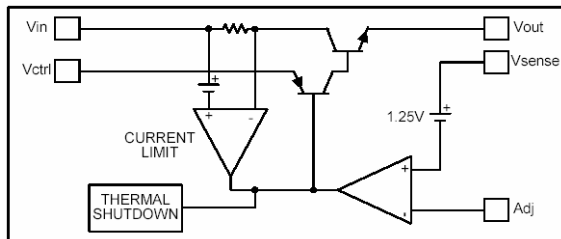

Marking :

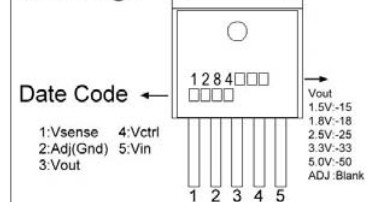

Pin Descriptions

Name	I/O	Description
Adj (Gnd)		A resistor divider from this pin to the Vout pin and ground sets the output voltage. (Gnd only for fixed mode)
Vsense	I	The pin is the positive side of the reference that allows remote load sensing to achieve excellent load regulation. A minimum of 10uF capacitor must be connected from this pin to ground to insure stability.
Vin	I	The input pin of regulator. Typically a large storage capacitor is connected from this pin to ground to insure that the input voltage does not sag below the minimum dropout voltage during the load transient response. This pin must always be higher than Vout in order for the device to regulate.
Vctrl	I	This pin is the supply pin for the internal control circuit as well as the base drive for the pass transistor. This pin must always be higher than the Vout pin in order the device to regulate. A minimum of 100uF capacitor must be connected from this pin to ground to insure stability.
Vout	O	The output of the regulator. A minimum of 100uF capacitor must be connected from this pin to ground to insure stability.

Absolute Maximum Ratings

Parameter	Symbol	Ratings	Unit
DC Supply Voltage	V _{IN}	16	V
Control Input Voltage	V _{CTRL}	18	V
Power Dissipation	P _D	2.4~4.4	W
Storage Temperature Range	T _{ST}	-65~+150	°C
Operating Junction Temperature Range	T _{OP}	0~+150	°C

Electrical Characteristics Unless otherwise specified, these specifications apply over, C_{in}=1uF, C_{out}=10uF, T_J=0~150°C.
Typical value refer to T_J=25°C. V_{out}=V_{sense}

Parameter	Conditions	MIN	TYP	MAX	UNIT
Reference Voltage	S5U1284-ADJ I _o =10mA, T _J =25°C, (V _{in} -V _{out})=0.7V, V _{ctrl} =V _{in} +1V	1.225	1.250	1.275	V
Output Voltage	S5U1284-15 I _o =10mA, T _J =25°C, 2.2V≤V _{in} ≤12V, V _{ctrl} =V _{in} +1V	1.470	1.500	1.530	V
	S5U1284-18 I _o =10mA, T _J =25°C, 2.5V≤V _{in} ≤12V, V _{ctrl} =V _{in} +1V	1.764	1.800	1.836	V
	S5U1284-25 I _o =10mA, T _J =25°C, 3.2V≤V _{in} ≤12V, V _{ctrl} =V _{in} +1V	2.450	2.500	2.550	V
	S5U1284-33 I _o =10mA, T _J =25°C, 4.0V≤V _{in} ≤12V, V _{ctrl} =V _{in} +1V	3.235	3.300	3.365	V
	S5U1284-50 I _o =10mA, T _J =25°C, 5.7V≤V _{in} ≤12V, V _{ctrl} =V _{in} +1V	4.900	5.00	5.100	V
Line Regulator	S5U1284-XX I _o =10mA, T _J =25°C, V _{out} +0.7<V _{in} <12, V _{ctrl} =V _{in} +1V	-	-	0.2	%
Load Regulation	S5U1284-ADJ (V _{in} -V _{out})=2V, 0mA<I _o <4A, T _J =25°C, V _{ctrl} =V _{in} +1V	-	-	1	%
	S5U1284-15 V _{in} =3.0V, 0mA<I _o <4A, T _J =25°C, V _{ctrl} =4V	-	12	15	mV
	S5U1284-18 V _{in} =3.3V, 0mA<I _o <4A, T _J =25°C, V _{ctrl} =4.3V	-	15	18	mV
	S5U1284-25 V _{in} =4.0V, 0mA<I _o <4A, T _J =25°C, V _{ctrl} =5V	-	20	25	mV
	S5U1284-33 V _{in} =5.0V, 0mA<I _o <4A, T _J =25°C, V _{ctrl} =6V	-	26	33	mV
	S5U1284-50 V _{in} =8.0V, 0mA<I _o <4A, T _J =25°C, V _{ctrl} =9V	-	40	50	mV
Dropout Voltage (V _{ctrl} -V _{out})	S5U1284-ADJ V _{adj} =0V, for all conditions below. (ΔV _{out} =1%V _{out}) V _{in} =2.05V, I _o =1.5A V _{in} =2.05V, I _o =3.0A V _{in} =2.05V, I _o =4.0A	-	1.10	1.15 1.18 1.25	V
	(fixed model) V _{in} = V _{out} +0.8V, I _o =4.0A (ΔV _{out} =1%V _{out})	-	1.10	1.25	V
Dropout Voltage (V _{in} -V _{out})	S5U1284-ADJ V _{adj} =0V, for all conditions below. (ΔV _{out} =1%V _{out}) V _{ctrl} =2.75V, I _o =1.5A V _{ctrl} =2.75V, I _o =3.0A V _{ctrl} =2.75V, I _o =4.0A	-	0.26 0.50 0.70	0.38 0.60 0.85	V
	S5U1284-15 V _{ctrl} =3.3V, I _o =4.0A (ΔV _{out} =1%V _{out})	-	0.70	0.85	V
	S5U1284-18 V _{ctrl} =V _{out} +1.5V, I _o =4.0A (ΔV _{out} =1%V _{out})	-	0.70	0.85	V
	S5U1284-25 V _{ctrl} =V _{out} +1.5V, I _o =4.0A (ΔV _{out} =1%V _{out})	-	0.70	0.85	V
	S5U1284-33 V _{ctrl} =V _{out} +1.5V, I _o =4.0A (ΔV _{out} =1%V _{out})	-	0.70	0.85	V
	S5U1284-50 V _{ctrl} =V _{out} +1.5V, I _o =4.0A (ΔV _{out} =1%V _{out})	-	0.70	0.85	V
Current Limit	V _{ctrl} =2.75V, V _{in} =2.05V, ΔV _o =100mV, V _{adj} =0V	4.2	-	-	A
Minimum Load Current	V _{ctrl} =5V, V _{in} =3.3V, V _{adj} =0V	-	5	10	mA
Thermal Regulation	30ms pulse	-	0.01	0.02	%/W
Ripple Rejection	V _{ctrl} =5V, V _{in} =5V, I _o =4.0A, V _{adj} =0V, T _J =25°C, V _{ripple} =1V _{pp} at 120Hz	60	70	-	dB
Control Pin Current	S5U1284-ADJ V _{adj} =0V, for all conditions below. V _{ctrl} =2.75V, V _{in} =2.05V, I _o =1.5A V _{ctrl} =2.75V, V _{in} =2.05V, I _o =3.0A V _{ctrl} =2.75V, V _{in} =2.05V, I _o =4.0A	-	6 30 33	25 60 70	mA
	S5U1284-15 V _{ctrl} =3.3V, V _{in} =2.3V, I _o =4.0A	-	33	70	mA
	S5U1284-18 V _{ctrl} =V _{out} +1.5V, V _{in} = V _{out} +0.8V, I _o =4.0A	-	33	70	mA
	S5U1284-25 V _{ctrl} =V _{out} +1.5V, V _{in} = V _{out} +0.8V, I _o =4.0A	-	33	70	mA
	S5U1284-33 V _{ctrl} =V _{out} +1.5V, V _{in} = V _{out} +0.8V, I _o =4.0A	-	33	70	mA
	S5U1284-50 V _{ctrl} =V _{out} +1.5V, V _{in} = V _{out} +0.8V, I _o =4.0A	-	33	70	mA
Adjust Pin Current	V _{ctrl} =2.75V, V _{in} =2.05V, I _o =10mA, V _{adj} =0	-	50	150	uA
Quiescent Current	V _{ctrl} =13V, V _{in} =12V, I _o =10mA (fixed model)	-	-	12	mA
Thermal Resistance Junction-to-Case	Control Circuitry/Power Transistor	-	3.5	-	°C/W

Note 1: S5U1284-ADJ incorporates an internal thermal shutdown that protects the device where the junction temperature exceeds the allowable maximum junction temperature.

Functional Description

Introduction

The S5U1284 regulator is 5-terminal device designed specifically to provide extremely low dropout voltage comparable to the PNP type without the disadvantage of the extra power dissipation due to the base current associated with PNP regulators. This is done by bringing out the control pin of the regulator that provides the base current to the power NPN and connecting it to a voltage that is greater than the voltage present at the Vin pin. This flexibility makes the S5U1284 ideal for applications where dual inputs are available such as a computer motherboard with an ATX style power supply that provides 5V and 3.3V to the board. One such application is the new graphic chip sets that require anywhere from 2.4V to 2.7V supply. The S5U1284 can easily be programmed with the addition of two external resistors to any voltages within the range of 1.25V to 15.5V. Another major requirement of these graphic chips is the need to switch the load current from zero to several amps in tens of nanoseconds at the processor pins, which translates to an approximately 300 to 500ns of current step at the regulator. In addition, the output voltage tolerances are also extremely tight and they include the transient response as part of the specification. The S5U1284 is specifically designed to meet the fast current transient needs as well as providing an accurate initial voltage, reducing the overall system cost with the need for fewer number of output capacitors. Another feature of the device is its true remote sensing capability that allows accurate voltage setting at the load rather than at the device.

Output Voltage Setting

The S5U1284 can be programmed to any voltage in the range of 1.25V to 15.5V with the addition of R1 and R2 external resistors according to the following formula:

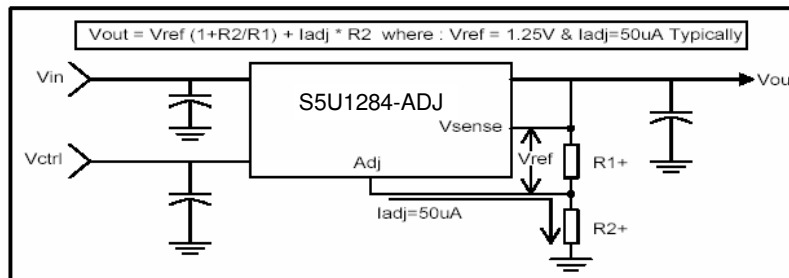

The S5U1284-ADJ keeps a constant 1.25V between the Vsense pin and the Adj pin. By placing a resistor R1 across these two pins and connecting the Vsense and Vout pin together, a constant current flows through R1, adding to the Iadj current and into the R2 resistor producing a voltage equal to the $(1.25/R1) * R2 + Iadj * R2$. This voltage is then added to the 1.25V to set the output voltage. This is summarized in the above equation. Since the min. load current requirement of the S5U1284-adj is 10mA, R1 is typically selected to be 121 Ohm resistor so that it automatically satisfies this condition. Notice that since Iadj is typically in the range of 55uA it only adds a small error to the output voltage and should only be considered when a very precise output voltage setting is required.

Load Regulator

Since the S5U1284 has separate pins for the output (Vout) and the sense (Vsense), it is ideal for providing true remote sensing of output voltage at the load. this means that the voltage drops due to parasitic resistance such PCB traces between the regulator and the load are compensated for using remote sensing. Figure following shows a typical application of the S5U1284-ADJ with remote sensing.

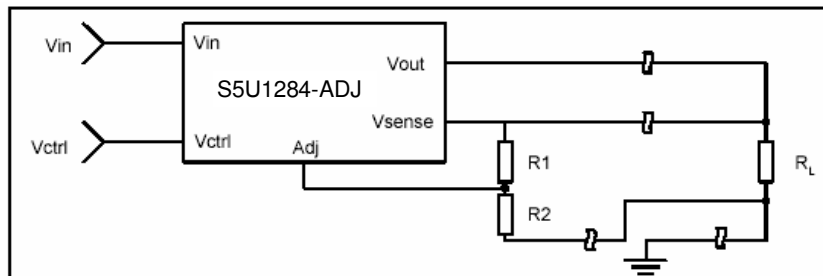

Stability

The S5U1284-XX requires the use of an output capacitor as part of the frequency compensation in order to make the regulator stable. Typical designs for the microprocessor application use standard electrolytic with typical ESR in the range of 50 to 100 mOhm and an output capacitance of 100uF to 1000uF. Fortunately as the capacitance increases, the ESR decreases resulting in a fixed RC time constant. The S5U1284-XX takes advantage of the phenomena in making the overakk regulator loop stable. For most applications a min. of 100uF aluminum electrolytic capacitor insures both stability and good transient response.

Thermal Design

The S5U1284-XX incorporates an internal thermal shutdown that protects the device when the junction temperature exceeds the maximum allowable junction temperatures. Although this device can operate with junction temperatures in the range of 150°C, it is recommended that the selected heat sink be chosen such that during maximum continuous load operation, the junction temperature is kept below this number. The example below shows the steps in selecting the proper surface mount package.

Assuming, the following conditions: $V_{out} = 2.5V$, $V_{in} = 3.3V$, $V_{ctrl} = 5V$, $I_{out} = 2A$ DC Avg.

Calculate the maximum power dissipation using the following equation: $P_d = I_{out} * (V_{in} - V_{out}) + (I_{out}/60) * (V_{ctrl} - V_{out})$

$$P_d = 2 * (3.3 - 2.5) + (2/60) * (5 - 2.5) = 1.68W$$

Using table below select the proper package and the amount of copper board needed.

Package	Copper Area	θ_{JA} (°C/W)	Max Pd (Ta=25°C)	Max Pd (Ta=45°C)
TO-263-5L	Pad Size 1.4" * 1.4"	25 ~ 45	2.4W ~ 4.4W	2.0W ~ 3.6W

Note: Above table is based on the max. junction temperature of 135°C.

Characteristics Curve

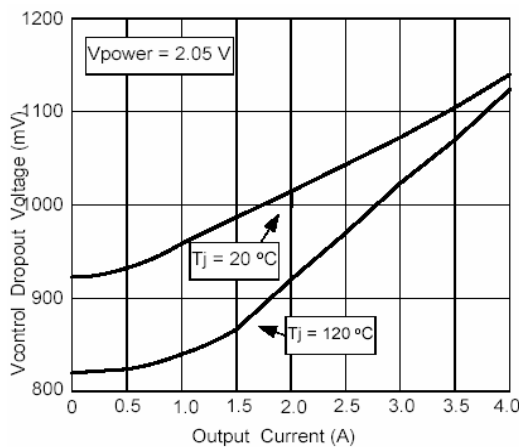

Vcontrol Dropout Voltage vs Output Current

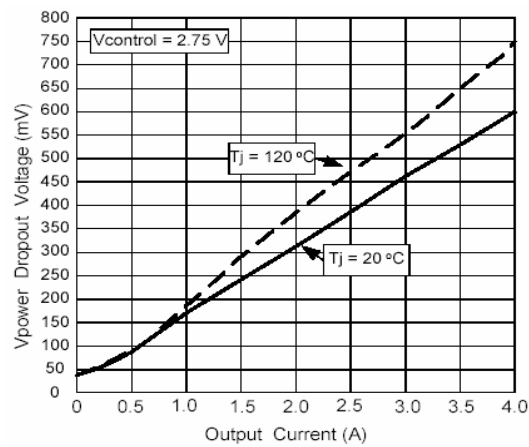

Vpower Dropout Voltage vs Output Current

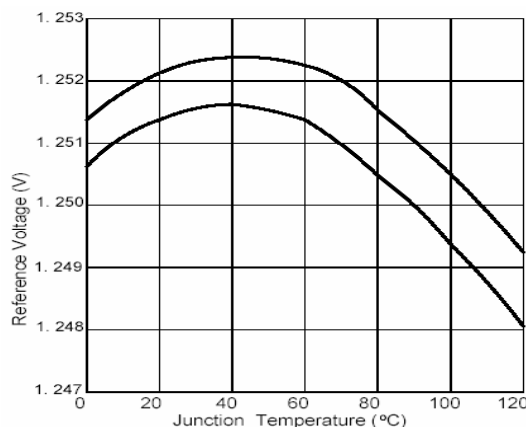

Reference Voltage vs Junction Temperature

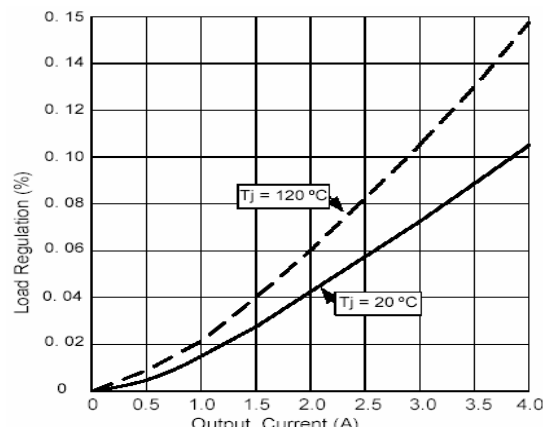

Load Regulation vs Output Current