

## 75 Ω VIDEO LINE DRIVER

### FEATURES

- Fixed Gain (6 dB)
- Internal 75 Ω Drivers
- Very Small Output Capacitor Using SAG Function Pin
- Active High ON/OFF Control
- Very Low Standby Current (typ.  $I_{STBY} \leq 25 \mu A$ )
- Internal Summing Circuit of Y/C Signal
- Single +5 V Power Supply Operation

### DESCRIPTION

Operating from a single +5 V supply, the TK15400 is a triple video line driver IC that takes standard Y/C analog inputs and provides simultaneous Y/C and composite analog outputs for driving 75 Ω lines. Internal summing of the Y and C inputs is performed to produce the composite video output. The luminance (Y) input is clamped at 1.25 V and amplified 6 dB to produce 2 V<sub>P-P</sub> (typical) into a series 75 Ω resistor and 75 Ω cable load. The internal 1.5 k SAG function resistor provides gain compensation for low frequency signals. The chrominance (C) input is biased at 2.0 V and amplified 6 dB to produce 1.3 V<sub>P-P</sub> (typical) into a series 75 Ω resistor and 75 Ω cable load. During standby (Pin 5 grounded), the TK15400 consumes only 113 μW of power. Nominal power dissipation (no input) is typically 168 mW.

The TK15400M is available in the SSOP-12 Surface Mount Package.

### APPLICATIONS

- Video Equipment
- Digital Cameras
- CCD Cameras
- TV Monitors
- Video Tape Recorders
- LCD Projectors

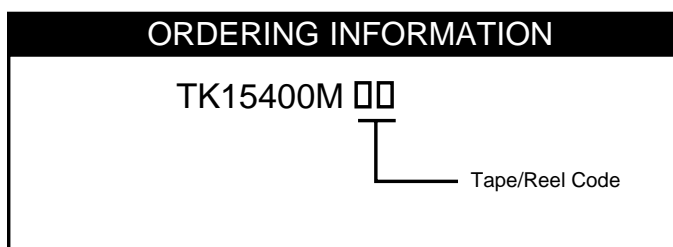
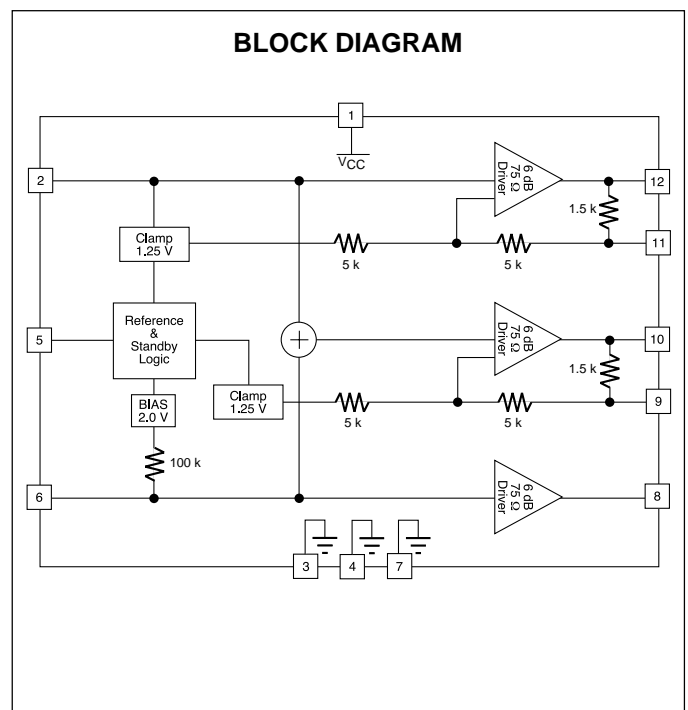
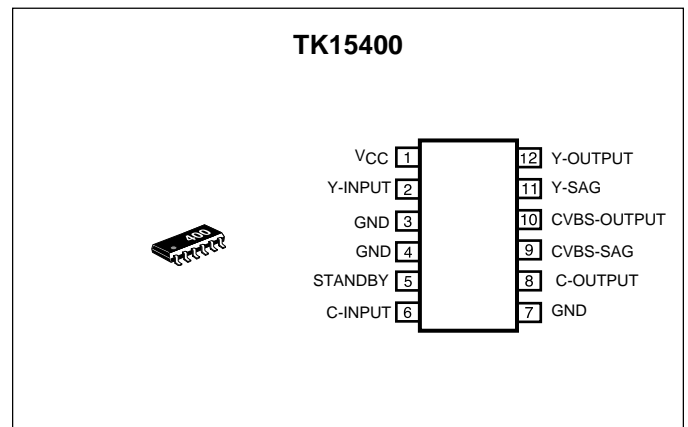

TAPE/REEL CODE  
TL: Tape Left

# TK15400

## ABSOLUTE MAXIMUM RATINGS

Supply Voltage ..... 6 V      Storage Temperature Range ..... -55 to +150 °C  
Operating Voltage ..... 4.5 to 5.5 V      Operating Temperature Range ..... -25 to +75 °C  
Power Dissipation (Note 1) ..... 350 mW

## TK15400M ELECTRICAL CHARACTERISTICS

Test conditions:  $V_{CC} = 5.0\text{ V}$ ,  $V_{IN} = 1.0\text{ V}_{P-P}$ ,  $R_L = 150\ \Omega$ ,  $T_A = 25\ ^\circ\text{C}$  unless otherwise specified.

SYMBOL	PARAMETER	TEST CONDITIONS	MIN	TYP	MAX	UNITS
$I_{CC}$	Supply Current	No input		33.5	45.0	mA
$I_{STBY}$	Standby Supply Current	Pin 5 Grounded		22.5	50.0	$\mu\text{A}$
$I_{OS}$	Standby Terminal Current	Pin 5 Standby mode		22.5	50.0	$\mu\text{A}$
$V_{THL}$	Threshold Voltage (High to Low)	Pin 5 Operating to Standby mode	GND	0.1	0.3	V
$V_{TLH}$	Threshold Voltage (Low to High)	Pin 5 Standby to Operating mode	1.8	2.0	$V_{CC}$	V
$V_{CMP}$	Clamp Voltage	Pin 2 Y signal input terminal	1.05	1.25	1.45	V
$V_{BIAS}$	Bias Voltage	Pin 6 C signal input terminal	1.70	2.00	2.30	V
GVA	Voltage Gain	$C_{IN} - C_{OUT}$ , $f_{in} = 1\text{ MHz}$	5.5	6.0	6.5	dB
DG	Differential Gain	Staircase wave input	-3.0	-1.5	+3.0	%
DP	Differential Phase	Staircase wave input	-3.0	-0.2	+3.0	deg
fr	Frequency Response	$f_{in} = 1\text{ MHz} / 5\text{ MHz}$		0.0		dB
CT1	Cross Talk 1	$Y_{IN} - C_{OUT}$		-40		dB
CT2	Cross Talk 2	$C_{IN} - Y_{OUT}$		-40		dB

Note 1: Power dissipation is 350 mW in free air. Derate at 2.8 mW/°C for operation above 25°C.

## TEST CIRCUIT

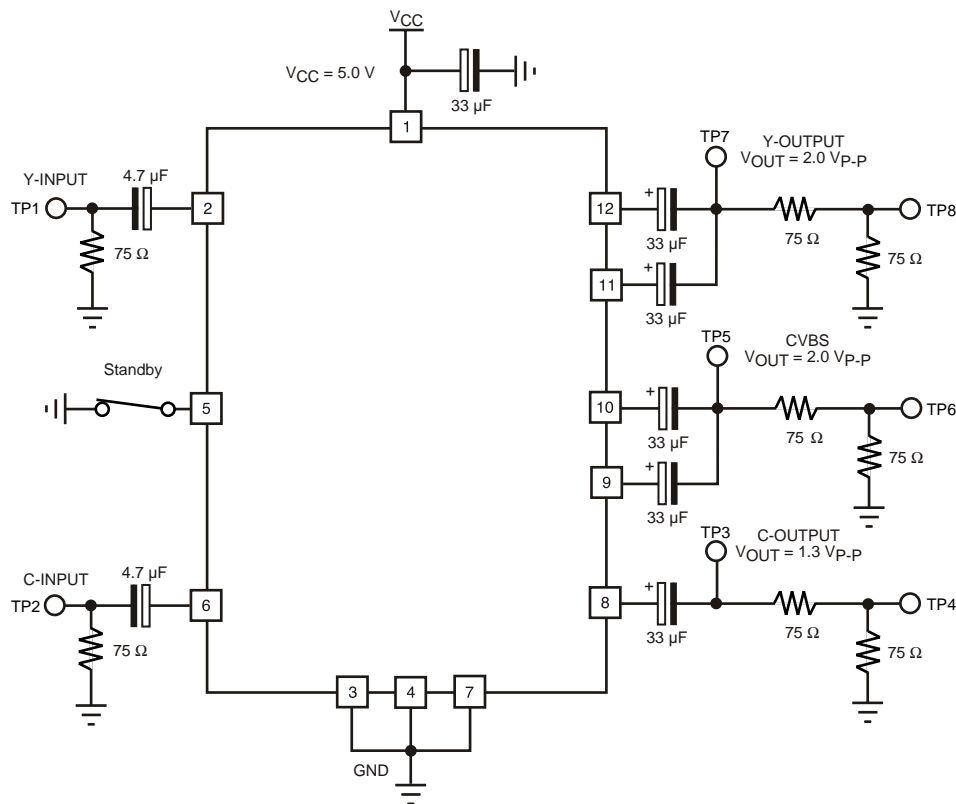

## MEASUREMENT METHOD

1. Supply Current ( $I_{CC}$ )

The Pin 1 current is measured with no input signal and the Standby Pin (Pin 5) open.

2. Standby Supply Current ( $I_{STBY}$ )

The Pin 1 current is measured when the Standby Pin (Pin 5) is connected to ground.

3. Standby Terminal Current ( $I_{OS}$ )

The Pin 5 current is measured when Pin 5 is connected to ground.

4. Threshold Voltage (High to Low) ( $V_{THL}$ )

The Pin 5 voltage is measured at the point which changes the device from operating mode into standby mode.

5. Threshold Voltage (Low to High) ( $V_{TLH}$ )

The Pin 5 voltage is measured at the point which changes the device from standby mode into operating mode.

6. Clamp Voltage ( $V_{CMP}$ )

The DC voltage at Pin 2 is measured with no input signal.

# TK15400

---

## MEASUREMENT METHOD (CONT.)

### 7. Bias Voltage ( $V_{BIAS}$ )

The DC voltage at Pin 6 is measured with no input signal.

### 8. Voltage Gain (GVA)

The voltage gain equation is as follows:

$$GVA = 20 \log_{10} V2/V1$$

Where V1 is the input voltage at TP1 and V2 is the measured voltage at TP5 (TP7). Furthermore, V1 is the input voltage at TP2 and V2 is the measured voltage at TP3 (TP5).

### 9. Differential Gain (DG)

The differential gain is measured at TP5 (TP7) when a staircase waveform of 10 steps is applied to TP1.

### 10. Differential Phase (DP)

The differential phase is measured at TP5 (TP7) when a staircase waveform of 10 steps is applied to TP1.

### 11. Frequency Response (fr)

The frequency response equation is as follows:

$$fr = 20 \log_{10} V2/V1$$

Where V1 is the measured TP7 voltage when the TP1 input frequency is set to 1 MHz and V2 is the measured TP7 voltage when the TP1 input frequency is set to 5 MHz. Furthermore, V1 is the measured TP3 (TP5) voltage when the TP2 input frequency is set to 1 MHz and V2 is the measured TP3 (TP5) voltage when the TP2 input frequency is set to 5 MHz.

### 12. Cross Talk 1 (CT1)

The cross talk equation is as follows:

$$CT1 = 20 \log_{10} V1/V2$$

Where V1 is measured at TP3 when a 1 MHz 1  $V_{p-p}$  input signal is applied to TP1 and V2 is measured at TP3 when a 1 MHz 1  $V_{p-p}$  input signal is applied to TP2.

### 13. Cross Talk 2 (CT2)

The cross talk equation is as follows:

$$CT2 = 20 \log_{10} V1/V2$$

Where V1 is measured at TP7 when a 1 MHz 1  $V_{p-p}$  input signal is applied to TP2 and V2 is measured at TP7 when a 1 MHz 1  $V_{p-p}$  input signal is applied to TP1.

## TYPICAL PERFORMANCE CHARACTERISTICS

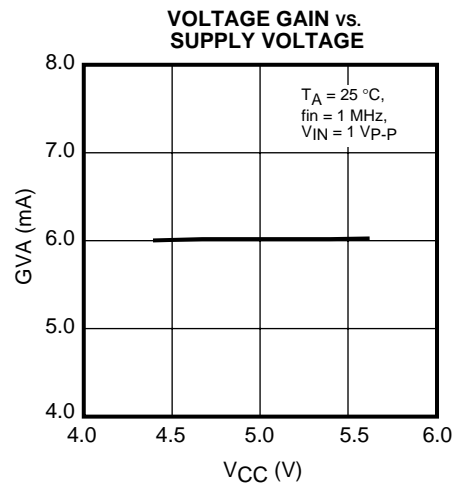
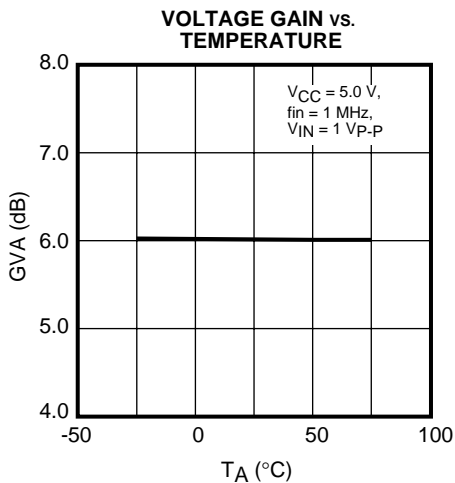
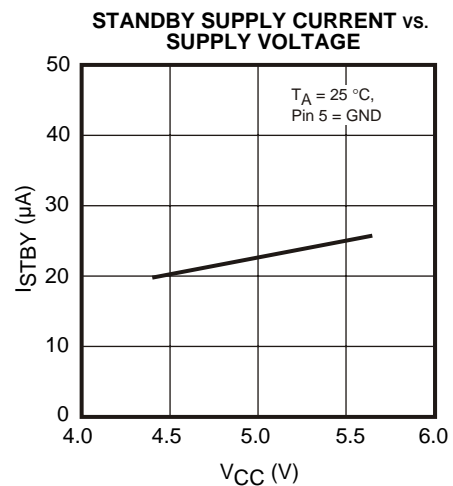
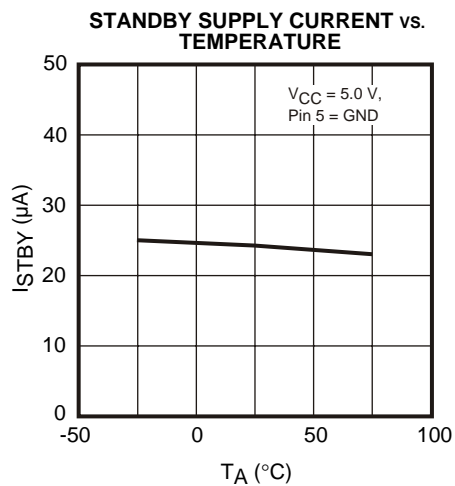
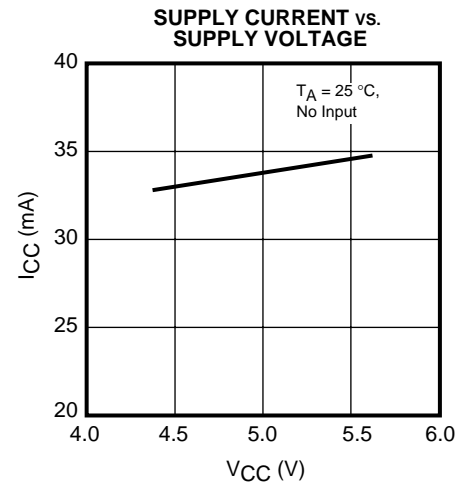
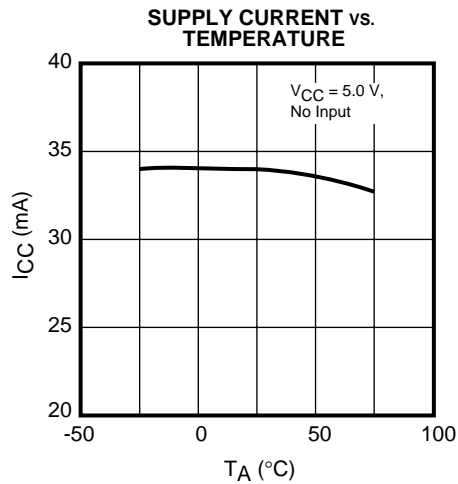

TYPICAL PERFORMANCE CHARACTERISTICS (CONT.)

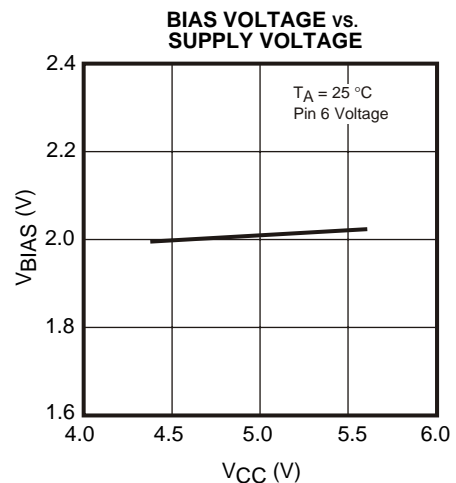
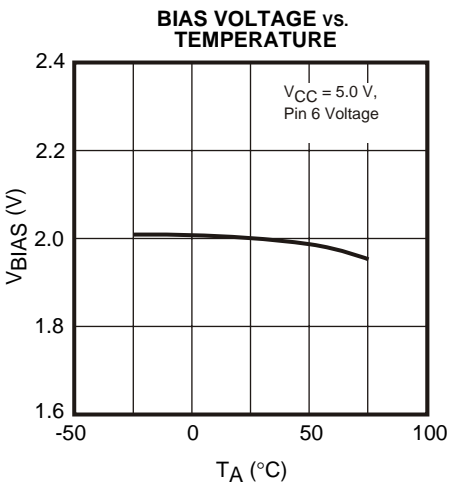
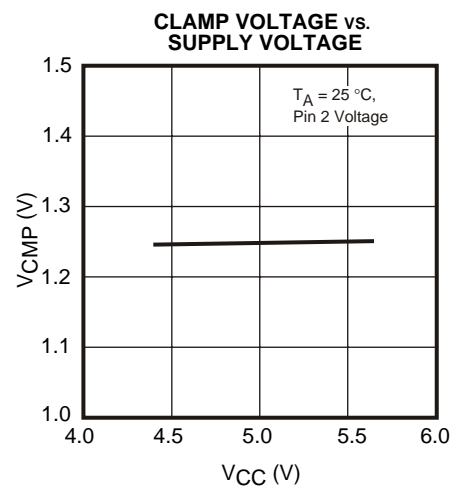
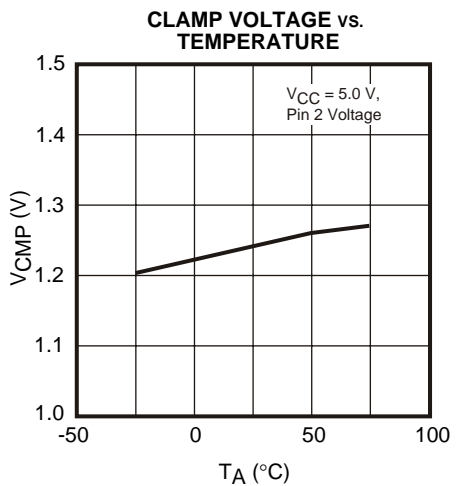
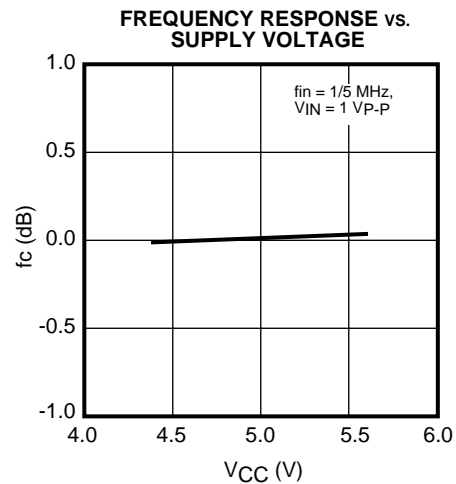
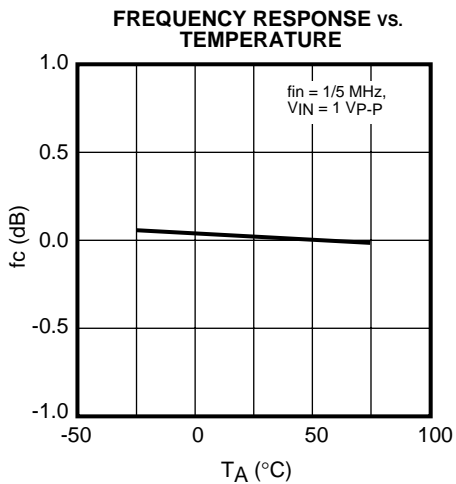

## TYPICAL PERFORMANCE CHARACTERISTICS (CONT.)

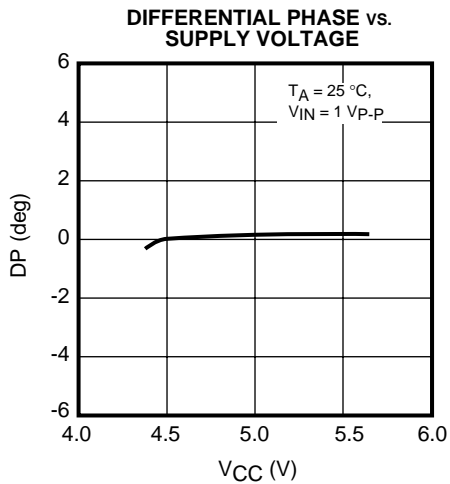
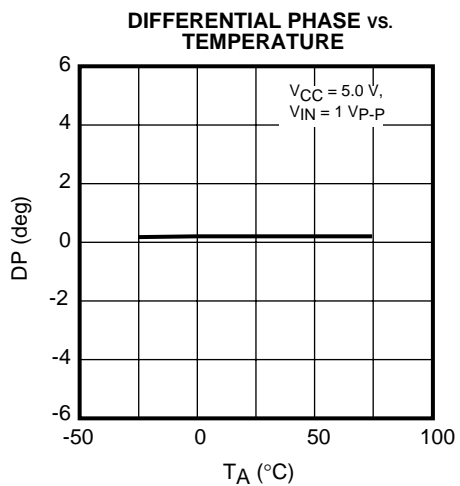
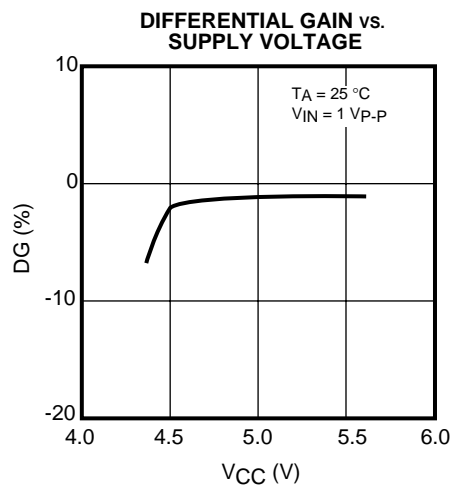
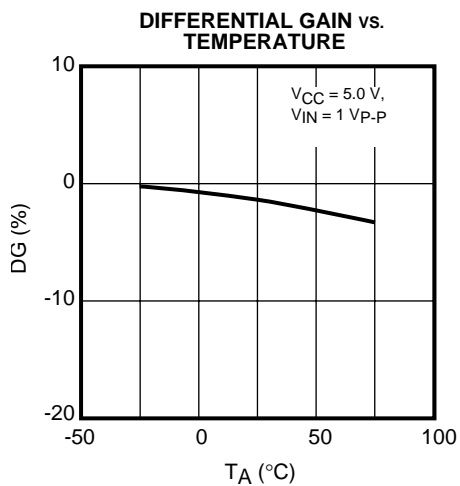

## PIN FUNCTION DESCRIPTION

TERMINAL			INTERNAL EQUIVALENT CIRCUIT	DESCRIPTION
PIN NO.	SYMBOL	VOLTAGE		
1	$V_{CC}$	$V_{CC}$		Power supply terminal
2	Y-INPUT	1.25 V		Pin 2 is the Y signal input terminal. The clamp circuit fixes the synchronous voltage to 1.25 V.
3,4	GND	GND		GND terminal
5	STANDBY	1.4 V		Pin 5 is the standby logic terminal. The device is in the active state when Pin 5 is pulled up to high level or open. The device is in the standby state when Pin 5 is pulled down to low level.
6	C-INPUT	2.0 V		Pin 6 is the C signal input terminal. The bias circuit fixes the C signal to 2.0 V by the 100 k $\Omega$ bias resistor.
7	GND	GND		GND terminal
8	C-OUTPUT	2.0 V		Pin 8 is the C signal output terminal. Pin 8 is available to drive a 75 $\Omega$ + 75 $\Omega$ load.



## PIN FUNCTION DESCRIPTION

TERMINAL			INTERNAL EQUIVALENT CIRCUIT	DESCRIPTION
PIN NO.	SYMBOL	VOLTAGE		
9	CVBS-SAG	1.25 V		<p>Pin 9 and Pin 10 are the CVBS signal output terminal and the CVBS-SAG terminal.</p> <p>Pin 11 and 12 are the Y signal output terminal and the Y-SAG terminal.</p> <p>These pins are available to drive <math>75 \Omega + 75 \Omega</math> loads.</p>
10	CVBS-OUTPUT	1.25 V		
11	Y-SAG	1.25 V		
12	Y-OUTPUT	1.25 V		

**NOTES**

**NOTES**

PACKAGE OUTLINE

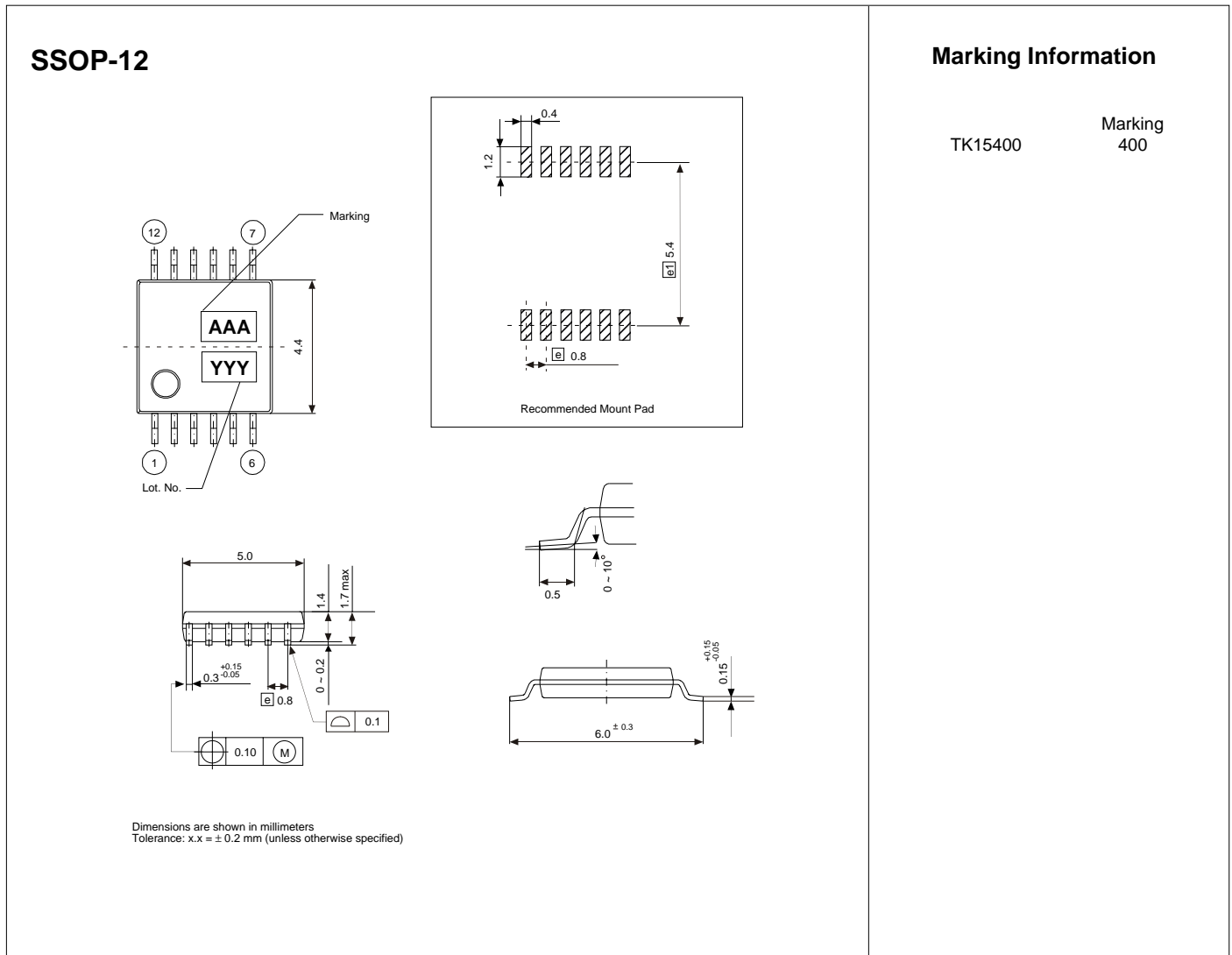

Toko America, Inc. Headquarters  
1250 Feehanville Drive, Mount Prospect, Illinois 60056  
Tel: (847) 297-0070 Fax: (847) 699-7864

TOKO AMERICA REGIONAL OFFICES

Midwest Regional Office  
Toko America, Inc.  
1250 Feehanville Drive  
Mount Prospect, IL 60056  
Tel: (847) 297-0070  
Fax: (847) 699-7864

Western Regional Office  
Toko America, Inc.  
2480 North First Street, Suite 260  
San Jose, CA 95131  
Tel: (408) 432-8281  
Fax: (408) 943-9790

Eastern Regional Office  
Toko America, Inc.  
107 Mill Plain Road  
Danbury, CT 06811  
Tel: (203) 748-6871  
Fax: (203) 797-1223

Semiconductor Technical Support  
Toko Design Center  
4755 Forge Road  
Colorado Springs, CO 80907  
Tel: (719) 528-2200  
Fax: (719) 528-2375

Visit our Internet site at <http://www.tokoam.com>

The information furnished by TOKO, Inc. is believed to be accurate and reliable. However, TOKO reserves the right to make changes or improvements in the design, specification or manufacture of its products without further notice. TOKO does not assume any liability arising from the application or use of any product or circuit described herein, nor for any infringements of patents or other rights of third parties which may result from the use of its products. No license is granted by implication or otherwise under any patent or patent rights of TOKO, Inc.