



Typical Applications

The HMC616LP3(E) is ideal for:

- Cellular/3G and LTE/WiMAX/4G
- BTS & Infrastructure
- Repeaters and Femtocells
- Public Safety Radio
- DAB Receivers

Features

- Low Noise Figure: 0.5 dB
- High Gain: 24 dB
- High Output IP3: +37 dBm
- Single Supply: +3V to +5V
- 50 Ohm Matched Input/Output
- 16 Lead 3x3mm QFN Package: 9 mm²

Functional Diagram

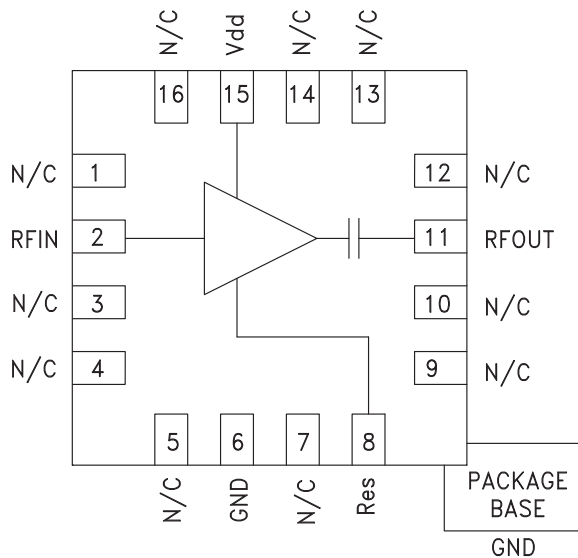

General Description

The HMC616LP3(E) is a GaAs PHEMT MMIC Low Noise Amplifier that is ideal for Cellular/3G and LTE/WiMAX/4G basestation front-end receivers operating between 175 and 660 MHz. The amplifier has been optimized to provide 0.5 dB noise figure, 24 dB gain and +37 dBm output IP3 from a single supply of +5V. Input and output return losses are excellent with minimal external matching and bias decoupling components. The HMC616LP3(E) shares the same package and pinout with the HMC617-LP3(E) and HMC618LP3(E) LNAs. The HMC616LP3(E) can be biased with +3V to +5V and features an externally adjustable supply current which allows the designer to tailor the linearity performance of the LNA for each application. The HMC616LP3(E) offers improved noise figure versus the previously released HMC356LP3(E).

Electrical Specifications, $T_A = +25^\circ C$, $R_{bias} = 3.92k\ Ohms^*$

Parameter	Vdd = +3V						Vdd = +5V						Units
	Min.	Typ.	Max.	Min.	Typ.	Max.	Min.	Typ.	Max.	Min.	Typ.	Max.	
Frequency Range	175 - 230			230 - 660			175 - 230			230 - 660			MHz
Gain	20	22.5		15	20		21	24		15	21		dB
Gain Variation Over Temperature					0.002						0.005		dB/°C
Noise Figure		0.5	0.8		0.5	0.8		0.5	0.8		0.5	0.8	dB
Input Return Loss		10			16			12			14		dB
Output Return Loss		9			10			9			10		dB
Output Power for 1 dB Compression (P1dB)	8	11		10	15		11	15		14	19		dBm
Saturated Output Power (Psat)	8.5	13		11	15.5		12.5	17.5		15.5	19.5		dBm
Output Third Order Intercept (IP3)		20			30			32			37		dBm
Supply Current (Idd)		30	45		30	45		90	115		90	115	mA

* Rbias resistor sets current, see application circuit herein

Broadband Gain & Return Loss

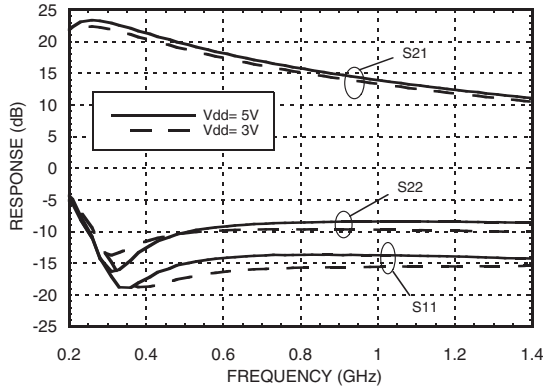

Gain vs. Temperature [1]

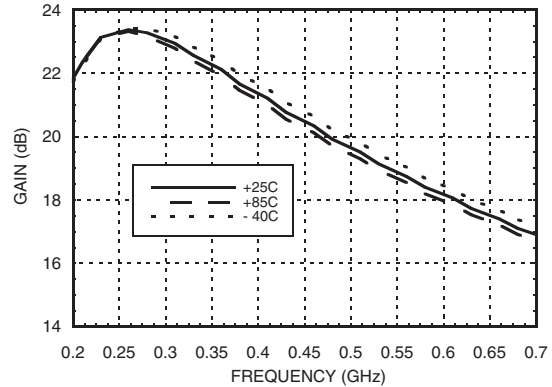

Gain vs. Temperature [2]

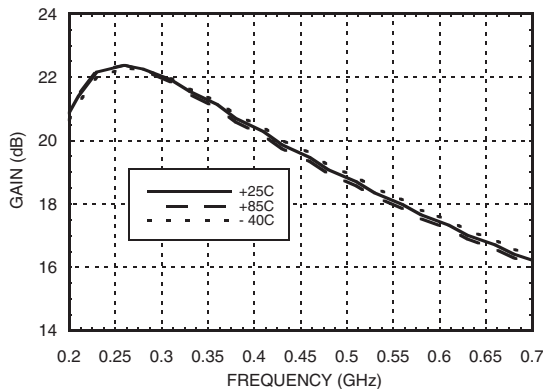

Input Return Loss vs. Temperature [1]

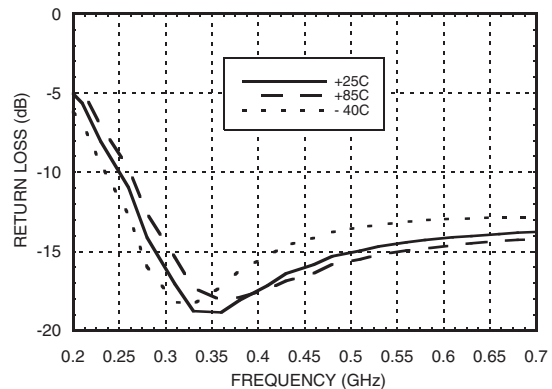

Output Return Loss vs. Temperature [1]

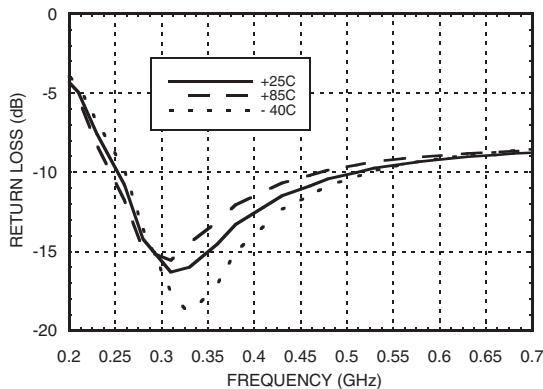

Reverse Isolation vs. Temperature [1]

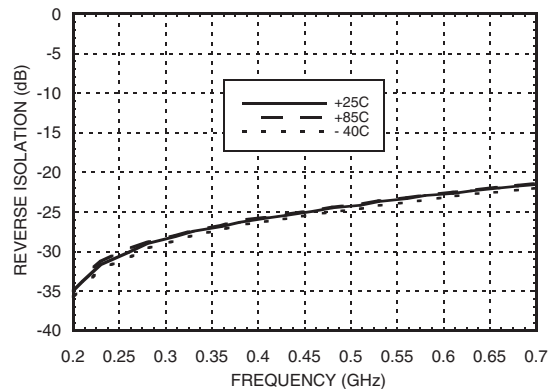

[1] V_{dd} = 5V [2] V_{dd} = 3V

Noise Figure vs. Temperature [1]

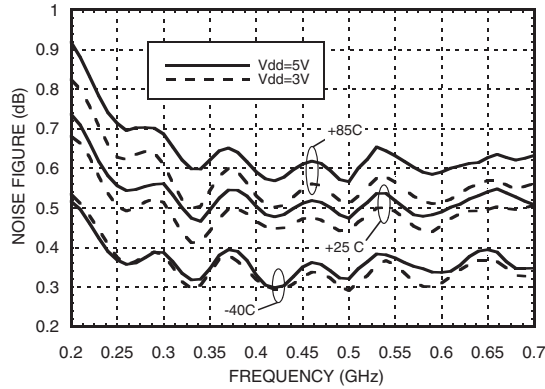

P1dB vs. Temperature

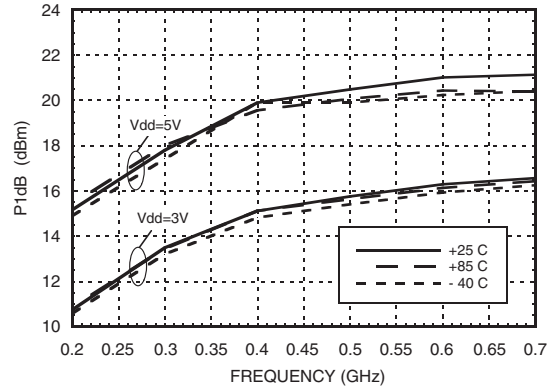

Psat vs. Temperature

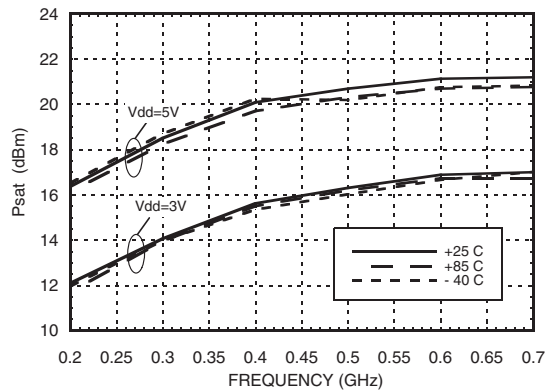

Output IP3 vs. Temperature

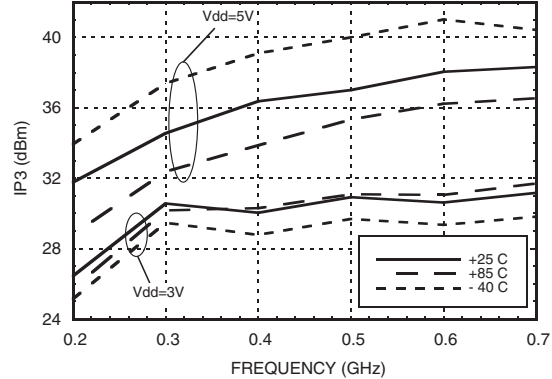

Output IP3 and Supply Current vs. Supply Voltage @ 400 MHz

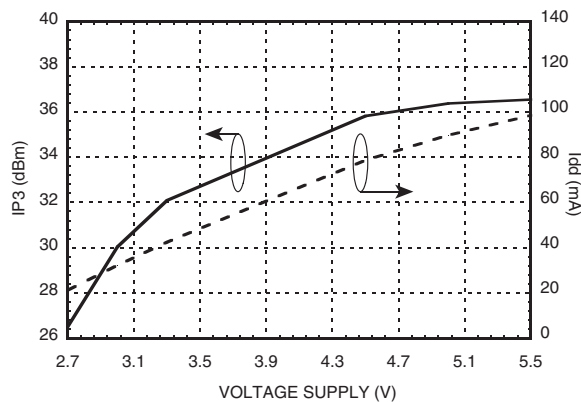

Output IP3 and Supply Current vs. Supply Voltage @ 500 MHz

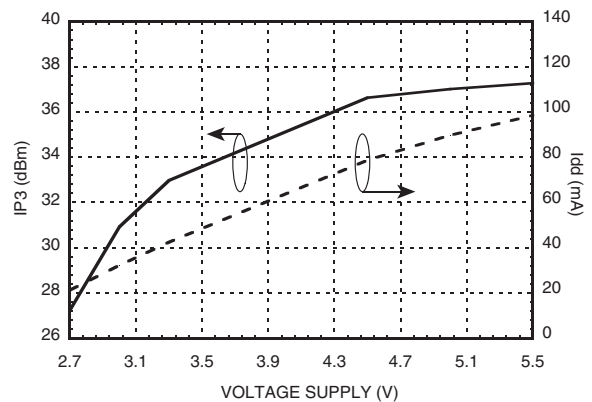

[1] Measurement reference plane shown on evaluation PCB drawing.



Power Compression @ 400 MHz [1]

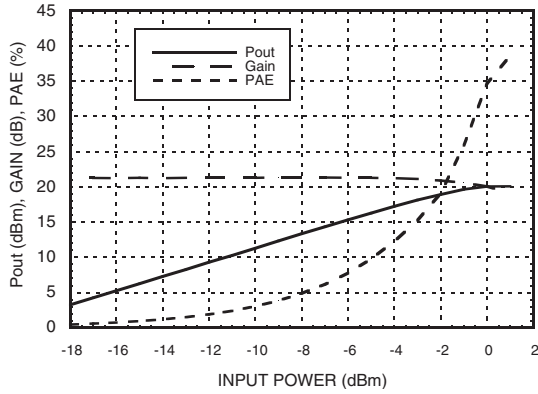

Power Compression @ 400 MHz [2]

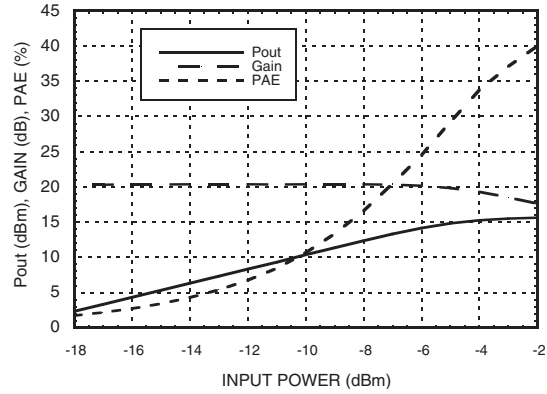

Power Compression @ 500 MHz [1]

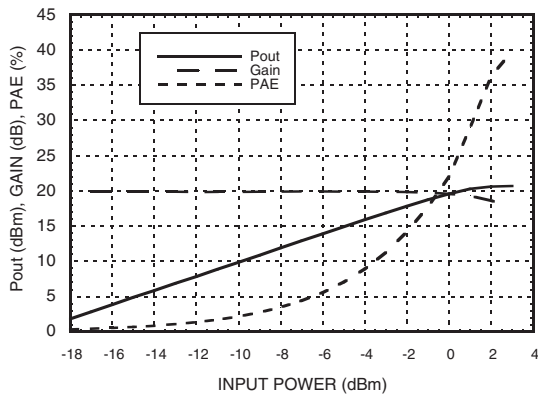

Power Compression @ 500 MHz [2]

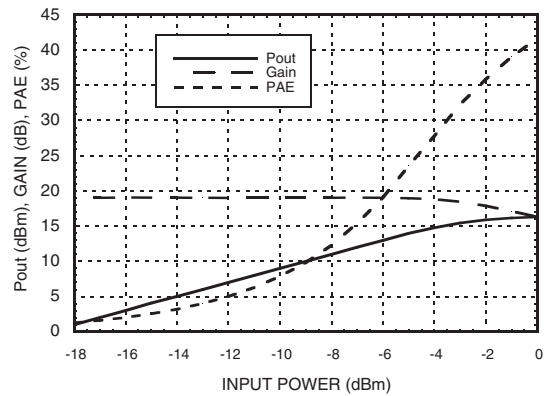

**Gain, Power & Noise Figure
vs. Supply Voltage @ 400 MHz**

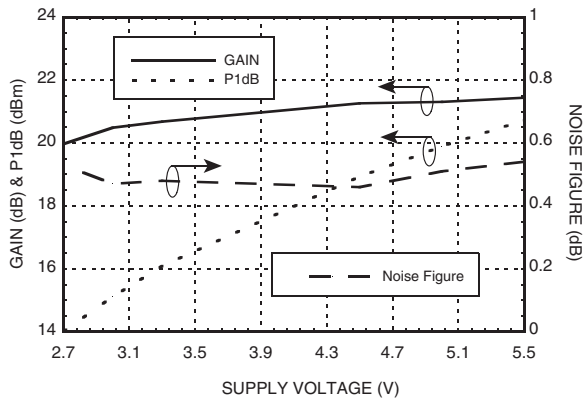

**Gain, Power & Noise Figure
vs. Supply Voltage @ 500 MHz**

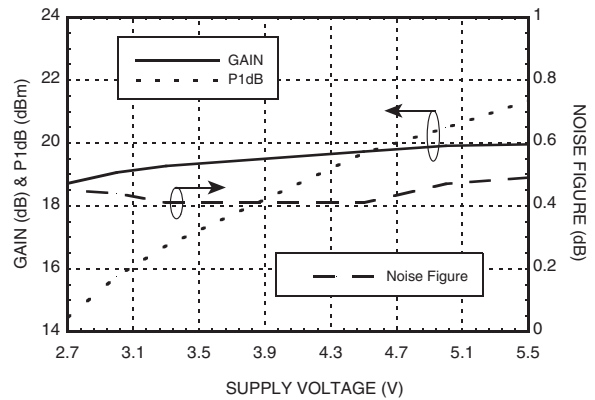

[1] Vdd = 5V [2] Vdd = 3V

Gain Low Frequency Tune [1]

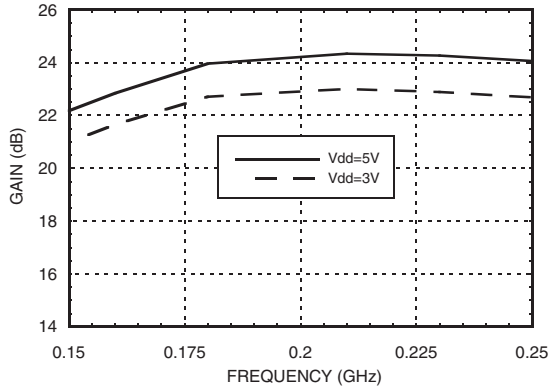

Input Return Loss Low Frequency Tune [1]

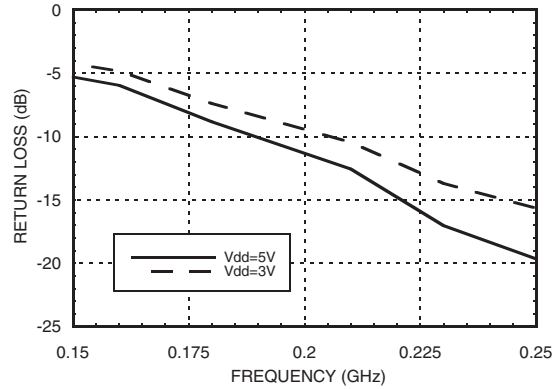

Output Return Loss Low Frequency Tune [1]

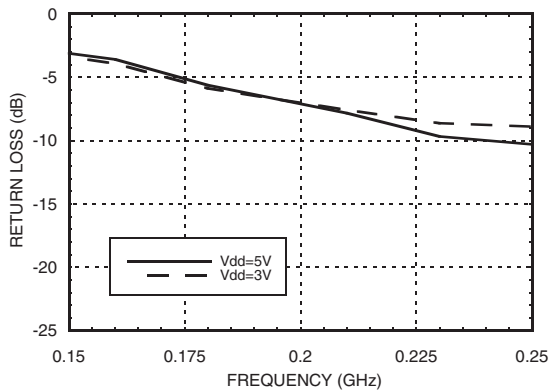

P1dB Low Frequency Tune [1]

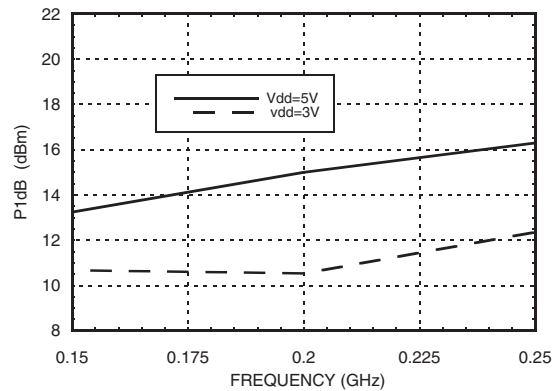

Output IP3 Low Frequency Tune [1]

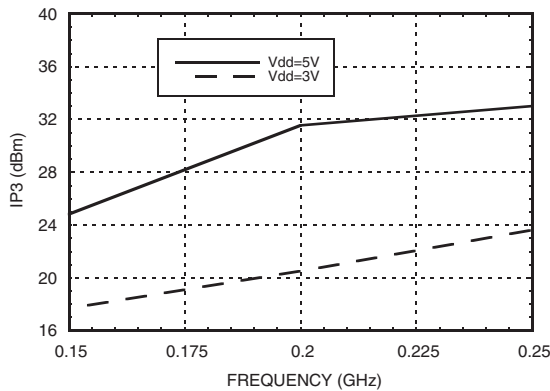

Noise Figure Low Frequency Tune [1] [2]

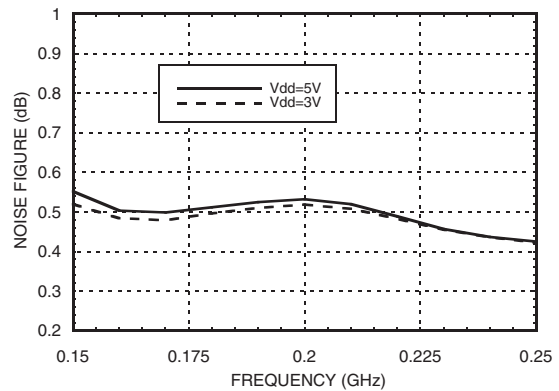

[1] Rbias = 2kΩ, L1 = 82 nH, L2 = 82 nH [2] Measurement reference plane shown on evaluation PCB drawing.



Output IP3 vs. Rbias @ 400 MHz

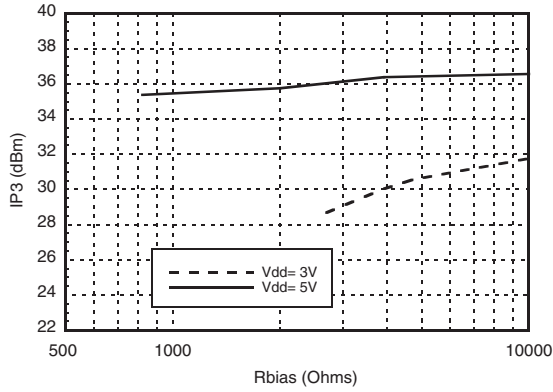

Gain, Noise Figure & Rbias @ 400 MHz

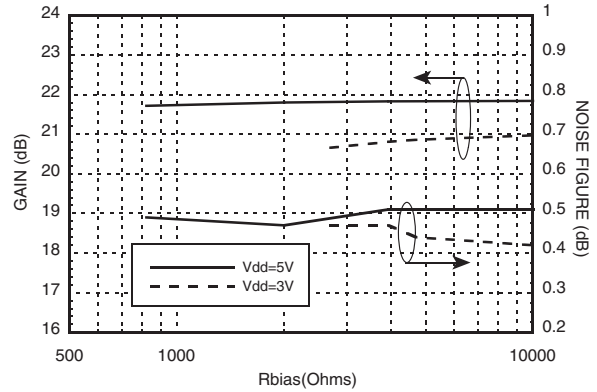

Output IP3 vs. Rbias @ 500 MHz

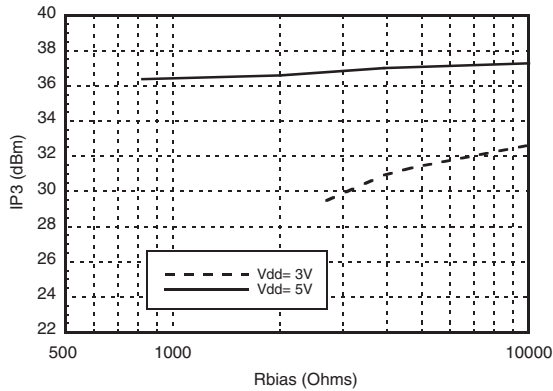

Gain, Noise Figure & Rbias @ 500 MHz

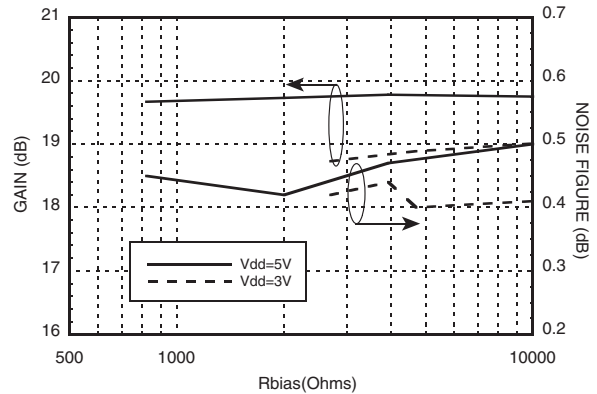

Absolute Bias Resistor
Range & Recommended Bias Resistor Values for I_{dd}

V _{dd} (V)	R _{bias} (Ω)			I _{dd} (mA)
	Min	Max	Recommended	
3V	1k [1]	Open Circuit	2.7k	27
			3.92k	31
			4.7k	33
			10k	39
5V	0	Open Circuit	820	73
			2k	84
			3.92k	91
			10k	95

[1] With V_{dd} = 3V, R_{bias} < 1k Ohm is not recommended and may result in the LNA becoming conditionally stable.

Absolute Maximum Ratings

Drain Bias Voltage (V _{dd})	+6 V
RF Input Power (RFIN) (V _{dd} = +5 V _{dc})	+10 dBm
Channel Temperature	150 °C
Continuous P _{diss} (T = 85 °C) (derate 8.93 mW/°C above 85 °C)	0.58 W
Thermal Resistance (channel to ground paddle)	112 °C/W
Storage Temperature	-65 to +150 °C
Operating Temperature	-40 to +85 °C

Typical Supply
Current vs. V_{dd} (R_{bias} = 3.92kΩ)

V _{dd} (V)	I _{dd} (mA)
2.7	20
3.0	30
3.3	40
4.5	80
5.0	90
5.5	100

Note: Amplifier will operate over full voltage range shown above.



**ELECTROSTATIC SENSITIVE DEVICE
OBSERVE HANDLING PRECAUTIONS**

Outline Drawing

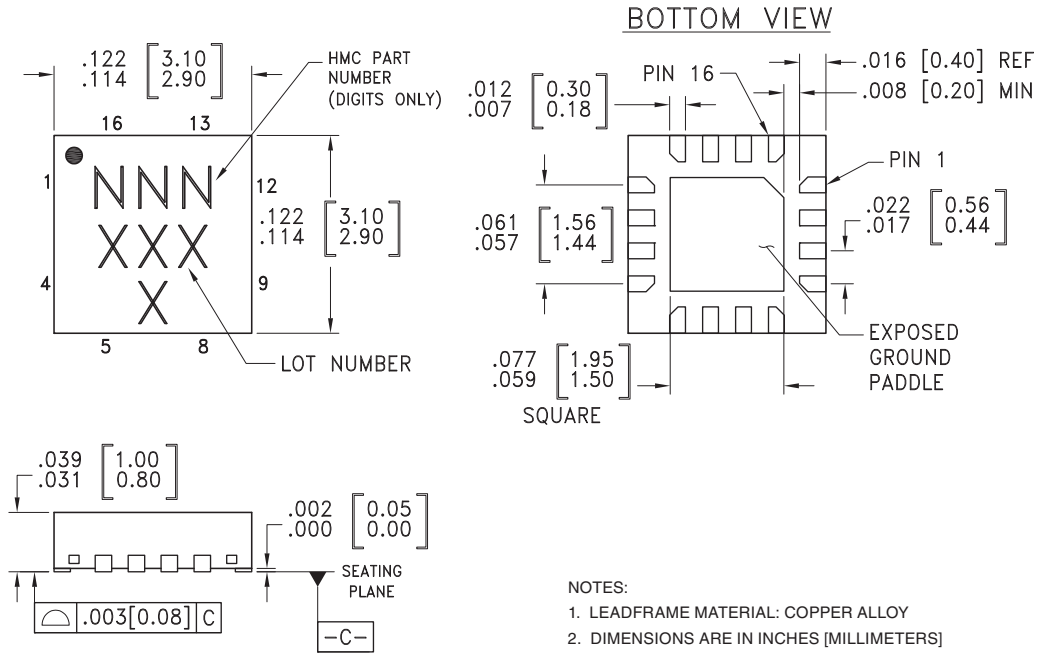

Package Information

Part Number	Package Body Material	Lead Finish	MSL Rating	Package Marking [3]
HMC616LP3	Low Stress Injection Molded Plastic	Sn/Pb Solder	MSL1 [1]	616 XXXX
HMC616LP3E	RoHS-compliant Low Stress Injection Molded Plastic	100% matte Sn	MSL1 [2]	616 XXXX

[1] Max peak reflow temperature of 235 °C
 [2] Max peak reflow temperature of 260 °C
 [3] 4-Digit lot number XXXX

Pin Descriptions

Pin Number	Function	Description	Interface Schematic
1, 3 - 5, 7, 9, 10, 12 - 14, 16	N/C	No connection required. These pins may be connected to RF/DC ground without affecting performance.	
2	RFIN	This pin is DC coupled. DC blocking capacitor required. See application circuit.	RFIN ○ ———
6	GND	This pin and ground paddle must be connected to RF/DC ground.	○ GND ⏏
11	RFOUT	This pin is matched to 50 Ohms.	—○ RFOUT ⏏
8	RES	This pin is used to set the DC current of the amplifier by selection of external bias resistor. See application circuit.	—○ RES ⏏
15	Vdd	Power Supply Voltage. Choke inductor and bypass capacitors are required. See application circuit.	Vdd ⏏

Application Circuit

Components for Selected Frequencies

Tuned Frequency	175 - 230 MHz	230 - 660 MHz
Rbias	2.0k Ohms	3.92k Ohms
L1	82 nH	47 nH
L2	82 nH	51 nH

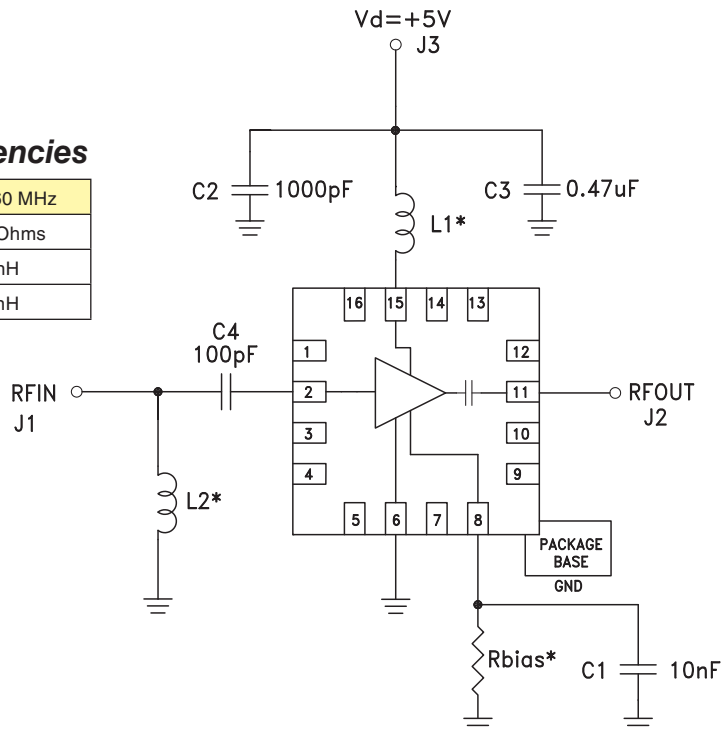

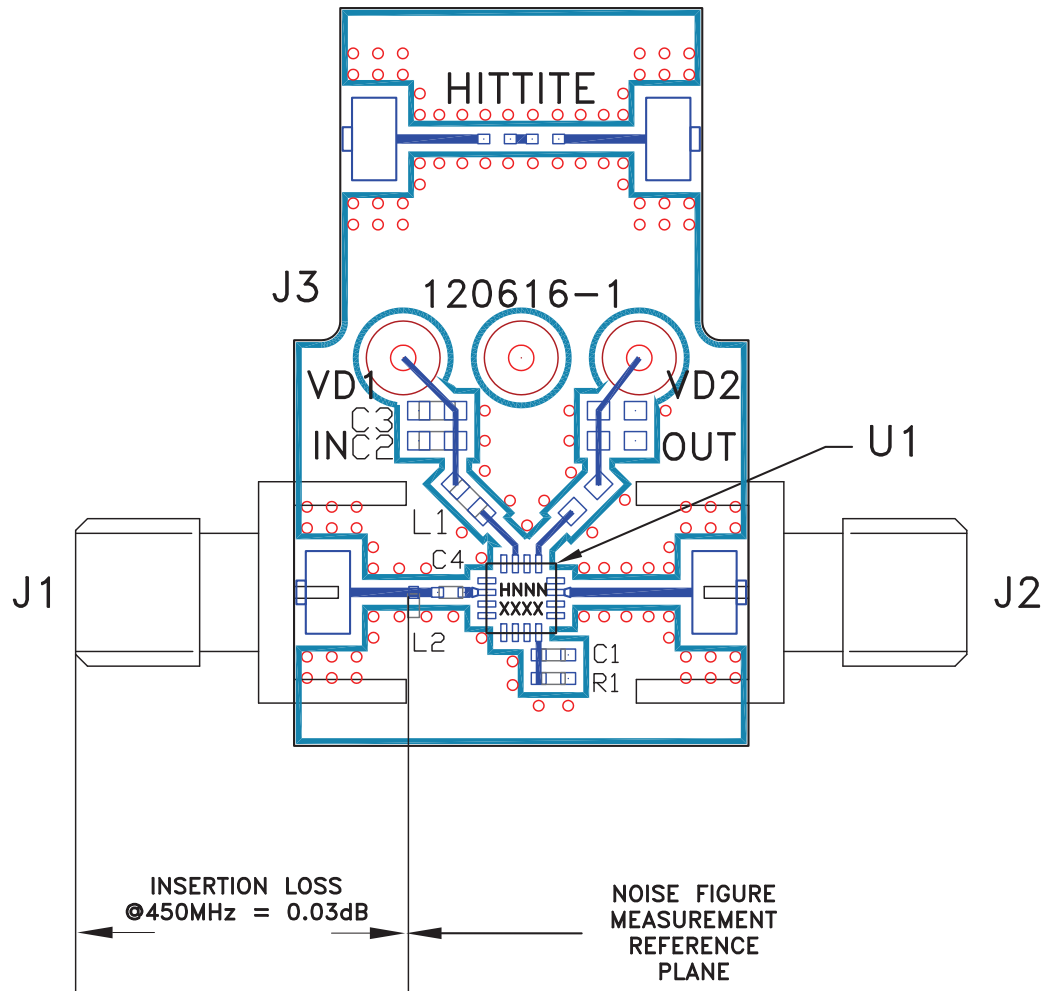
Evaluation PCB

List of Materials for Evaluation PCB 120728 [1]

Item	Description
J1, J2	PCB Mount SMA RF Connector
J3, J4	DC Pin
C1	10nF Capacitor, 0402 Pkg.
C2	1000 pF Capacitor, 0603 Pkg.
C3	0.47 μ F Capacitor, 0603 Pkg.
C4	100 pF Capacitor, 0402 Pkg.
L1	47 nH Inductor, 0603 Pkg.
L2	51 nH Inductor, 0402 Pkg.
R1 (Rbias)	3.92 k Ω Resistor, 0402 Pkg.
U1	HMC616LP3(E) Amplifier
PCB [2]	120616 Evaluation PCB

[1] Reference this number when ordering complete evaluation PCB

[2] Circuit Board Material: Rogers 4350.

The circuit board used in this application should use RF circuit design techniques. Signal lines should have 50 Ohm impedance while the package ground leads and exposed paddle should be connected directly to the ground plane similar to that shown. A sufficient number of via holes should be used to connect the top and bottom ground planes. The evaluation board should be mounted to an appropriate heat sink. The evaluation circuit board shown is available from Hittite upon request.