



Photo-receiver Amplifier

General Description

The epc13x family products are monolithic, integrated high sensitive photo-diode amplifiers for light-barrier, light-curtain, and the like applications. It amplifies current pulses from reverse-biased PIN photodiodes (e.g. BP104 by OSRAM) and discriminates the amplified input light pulse before driving the open-drain output stage. The device is controlled by an internal digital controller, which uses no external clock signal. The power supply of the device can be connected in anti-polar mode to decrease the wiring effort in matrix operated light-curtain products. The device has been optimized to utilize the least count of external components.

This device allows the design of short to long range light barriers from a few millimeters up to tens of meters.

epc130/epc131 are the same devices but with an analog output. Please refer to the corresponding data sheet epc130/epc131.

Features

- Low current consumption
- Digital output
- Reverse polarity protection
- Two-wire and open drain output interface
- High sensitivity (epc135/138)
- Fast versions available (epc136/139)
- Light reserve output (epc135/136)
- High sensitivity and light reserve output (epc134)
- CSP6 package with very small footprint and standard QFN16 package available

Applications

- Light barriers ranging from millimeters to tens of meters
- Light curtains
- Smoke detectors
- Liquid detectors
- Heart beat monitors

Device selection table

Model	Output		Light Reserve Output		Response Time		Sensitivity			
	digital	analog	w/o	with	slow	fast	low	medium	high	very high
epc130		x	x		x					
epc131		x	x			x				
epc134	x			x		x		x		
epc135	x			x	x				x	
epc136	x			x		x	x			
epc137	x		x		x					x
epc138	x		x		x				x	
epc139	x		x			x	x			

Functional Block Diagram

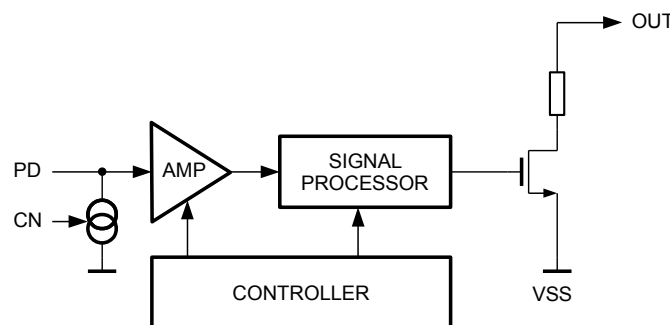

Absolute Maximum Ratings (Notes 1, 2)		Recommended Operating Conditions			
Power Supply Voltage V_{DD}	-5.5V to +5.5V	Min.	Max.	Units	
Voltage to Any pin	-0.3 to V_{DD} +0.3V	Power Supply Voltage (V_{DD})	4.0	5.2	V
Maximum Power Dissipation	300mW	Operating Temperature (T_A)	-40°	+85°	C
Storage Temperature Range (T_S)	-40°C to +85°C	Humidity	+5	+95	%
Lead Temperature solder, 4 sec. (T_L)	+260°C				

Note 1: Absolute Maximum Ratings indicate limits beyond which damage to the device may occur. Recommended operating conditions indicate conditions for which the device is intended to be functional, but do not guarantee specific performance limits. For guaranteed specifications and test conditions, see Electrical Characteristics.

Note 2: This device is a highly sensitive CMOS ac current amplifier with an ESD rating of JEDEC HBM class 0 (<250V). Handling and assembly of this device should only be done at ESD protected workstations.

Electrical Characteristics

$V_{DD} = 5.0\text{ V}$, $-40^\circ\text{C} < T_A < +85^\circ\text{C}$

Symbol	Parameter		Conditions/Comments	Values			Units
				Min.	Typ.	Max.	
V_{PP}	Ripple on Supply Voltage	epc135	Sinusoidal 100kHz, refer to other parameters			40	mV _{pp}
		epc138					
		epc137	Sinusoidal 800kHz, refer to other parameters			22	
		epc136				110	
		epc139					
	epc134				45		
I_{DD}	Power Supply Current	All slow	no photo diode current		0.45	0.50	mA
		All fast			0.75	0.80	
V_{PD}	Reversed Photodiode Voltage		relative to VDD		VDD-1.55		V
I_{PD}	Input Pulse Threshold (Sensitivity)	epc137	Photodiode current pulse to generate an output pulse		40		nA
		epc135		60	80	100	nA
		epc138		200	400	600	nA
		epc134		600	800	1000	nA
	epc136						
	epc139						
I_{PDres}	Input Pulse Threshold Reserve	epc134 - epc137	Input pulse current relative to I_{PD} to trigger the light reserve output		150		%
I_{PDmax}	Input Pulse Current		If input current is above this level, recovery time t_{REC} is undefined (refer to section 'Other Parameters')			100	μA
I_{PDDC}	DC Light Current Range		refer to section 'Application Information, Ambient Light'	0.0		3.0	mA
C_{PD}	Photodiode Capacitance	epc135	refer to section 'Application Information, Photodiode Capacitance'	15		50	pF
		epc137					
		epc138					
		epc134		30		40	
		epc136					
		epc139					
I_{OUT}	Output Current (sink)		When a light pulse above the threshold is detected	-6.0	-8.0	-10.0	mA
V_{POR}	Power-up Threshold Voltage		The voltage at VDD when the device starts up and the startup time is running.	3.0	3.5	4.0	V
V_{IPOR}	Hysteresis		on Power-up Threshold Voltage	0.5	0.75	1.0	V
t_{INIT}	Power-up Startup Time		VDD slew rate >100V/ms			1.5	ms
t_{OFF}	Power-down Time					1.5	ms

Symbol	Parameter	Conditions/Comments	Values			Units
			Min.	Typ.	Max.	
t _{REC}	Recovery Time	epc135 epc137 epc138	80	110	130	μs
		epc134 epc136 epc139			25	
t _{OUT}	Output Pulse Width at pin OUT	epc135 epc137 epc138	17	22	28	μs
		epc134 epc136 epc139	1.5	2.0	2.5	
t _{PD}	Input Pulse Width at pin PD	epc135 epc137 epc138		6		μs
		epc134 epc136 epc139		0.75		
t _{ri}	Input pulse slew rate	epc135 epc137 epc138		500		ns
		epc134 epc136 epc139		50		
R _{PD}	Photodiode bias resistor	epc135 epc137 epc138		27		kΩ
		epc134		6.8		
		epc136 epc139		4.7		

Connection Diagrams

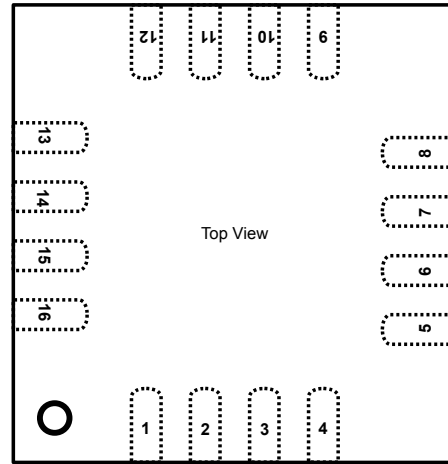
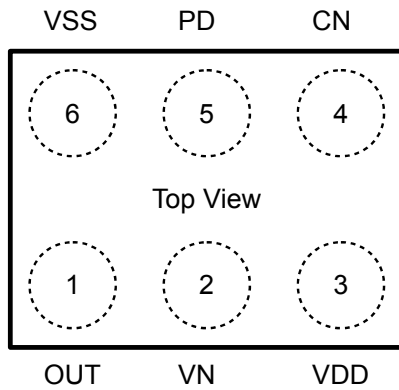

6-Pin Chip Scale Package (CSP)

16-Pin QFN Package

6-Pin CSP	16-Pin QFN	Pin Name	Description
1	16	OUT	Open drain pull down output pin. The output transistor is active if a photo-current signal is detected. Please note that there is no internal pull-up resistor.
2	3	VN	Negative power supply pin through a reverse-polarity protection diode.
3	13	VDD	Positive power supply pin.
4	8	CN	External capacitor for background light current regulator.
5	11	PD	Anode of photo diode. This is the analog input of the amplifier/filter circuitry.
6	5	VSS	Negative power supply pin.
n/a	1	NC	Not connected.
n/a	2	NC	Not connected.
n/a	4	NC	Not connected.
n/a	6	NC	Not connected.
n/a	7	NC	Not connected.
n/a	9	NC	Not connected.
n/a	10	NC	Not connected.
n/a	12	NC	Not connected.
n/a	14	NC	Not connected.
n/a	15	NC	Not connected.

Other Parameters

(typical values, $T_{amb} = 25^{\circ}C$, $V_{DD} = 5.0V$)

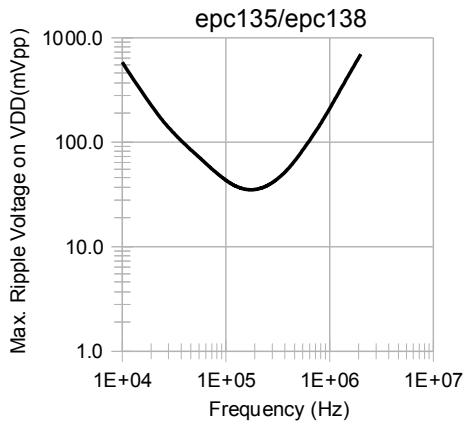
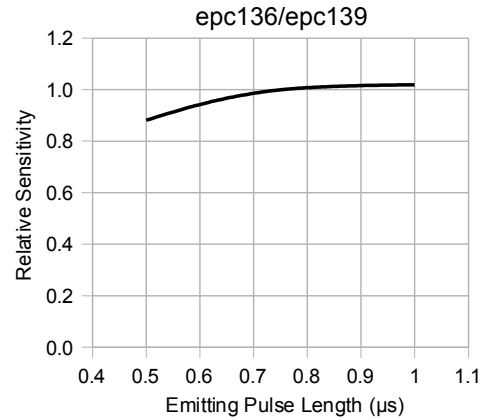
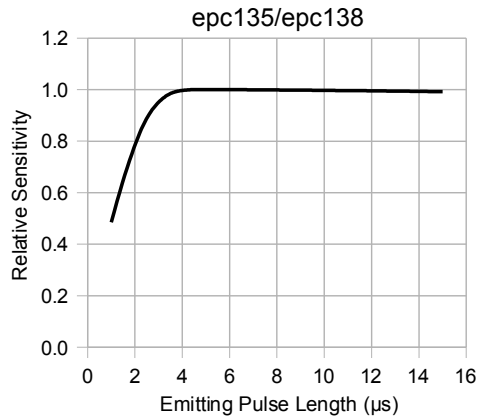

Max. ripple voltage on VDD until output is triggered

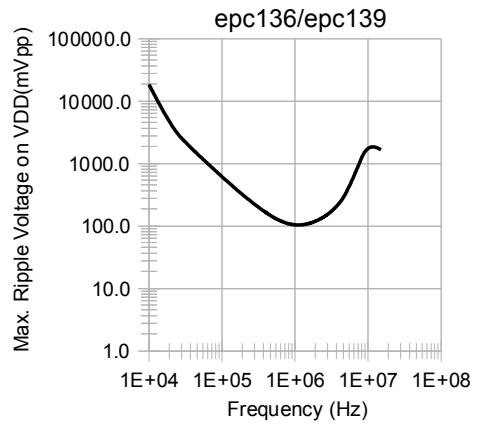

Max. ripple voltage on VDD until output is triggered

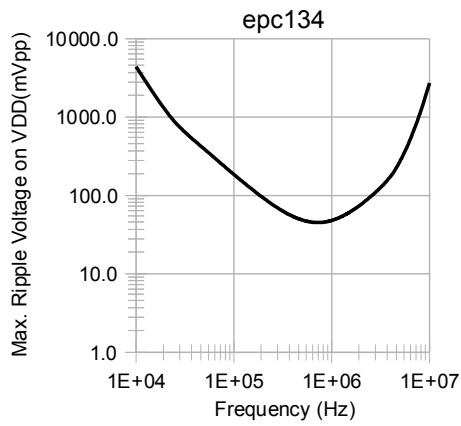
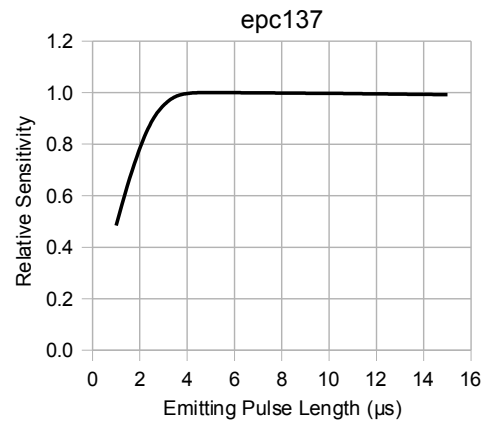
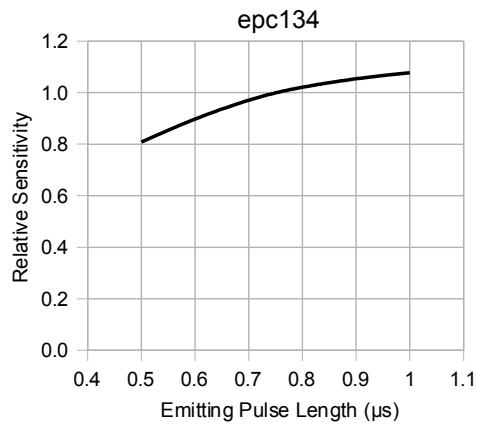

Max. ripple voltage on VDD until output is triggered

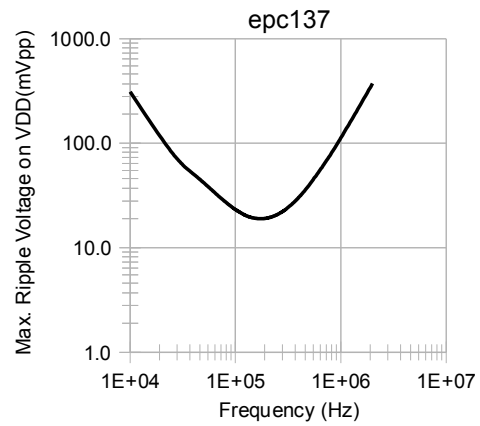

Max. ripple voltage on VDD until output is triggered

Functional Description

Power-up Sequence

If V_{DD} reaches V_{POR} , the startup sequence is initiated. After the time t_{DEL} , the photo diode bias circuit is enabled. Thus, a current generated by light on the photo diode flows into the pin PD. After the time t_{INIT} , the device is ready to receive AC light pulses.

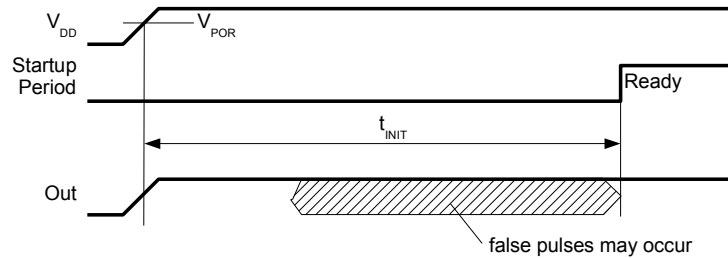

Power-up sequence

Power-down Sequence

When V_{DD} goes down, the device is turned off when V_{DD} is below V_{POR} minus V_{IPOR} .

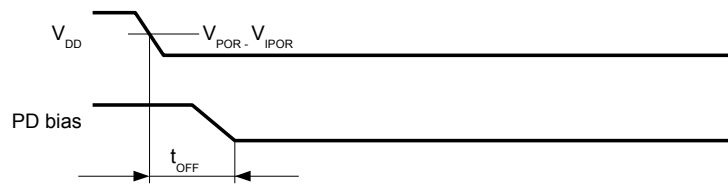

Power-down sequence

Light Pulse Reception

A light pulse on the photo diode generates a current pulse into the pin PD of the device. If the current pulse exceeds the threshold I_{PD} , an output pulse is generated. The length of the output pulse is given by t_{OUT} . After a waiting time given by t_{REC} , the next light pulse can be sent. If the waiting time is too short, the device is not ready to receive the next pulse. Thus, no output pulse is appears at pin OUT.

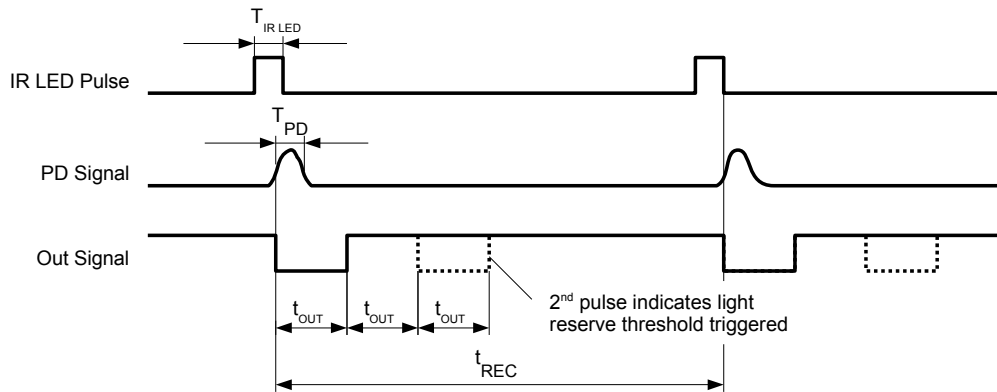

Light pulse reception

Application Information

Light Barrier Application

The following circuit is recommended to operate the epc134/135/136/137/138/139 as a photo diode amplifier in a single beam light barrier:

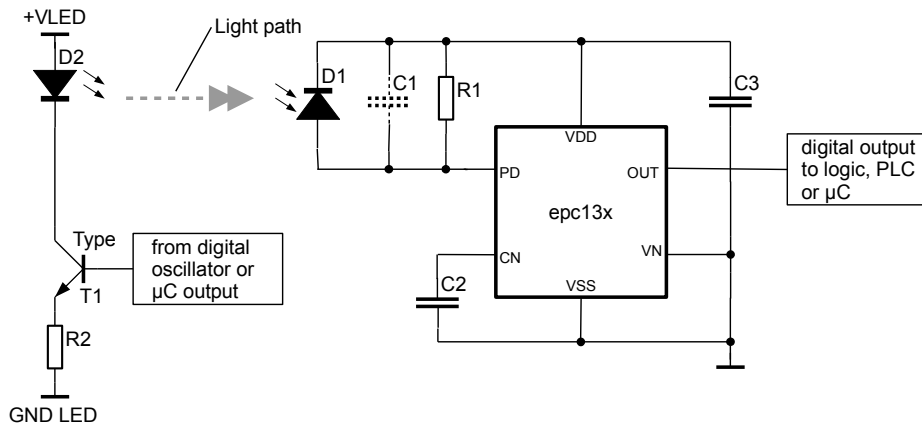

Recommended Components Values

R1: 27k(epc135/137/138), 6.8k(epc134) and 4.7k (epc136/139) (bias resistor). Sensitivity can be reduced by the reduction of this resistor.

R2: dependent on the required LED current

C1: Usually not needed. May be up to 100 pF (refer to section 'Photodiode Capacitance').

C2: 33nF (DC input current filter capacitor)

C3: 100nF or greater (power supply filter capacitor)

D1: PIN photo diode, BP104 (OSRAM) or similar devices

D2: IR LED, TSML1000 (Vishay) or similar devices

Working Principle

The IR LED D2 emits light pulses which are sent towards the photo diode D1. If there is no obstacle between the two devices, the light pulse generates an AC current (I_{PD}) in the reverse biased photo diode D1 into the pin PD. I_{PD} is proportional to the power of the light pulse. If I_{PD} is greater than the trigger threshold of the circuitry in the device, a pulse at the pin OUT is generated. If I_{PD} is greater than the trigger threshold for the light reserve (I_{PDres}), a second pulse at the output is generated. The length of the output pulse is given by t_{OUT} . Once a light pulse is generated by the IR LED, a next light pulse must not be generated until the recovery time t_{REC} (max.).

Design Precautions

The sensitivity at pin PD is very high in order to achieve a long operation range of light barriers even without lenses in front of the IR LED and/or the photo diode. Thus, the pin PD is very sensitive to EMI. Special care should be taken to keep the PCB track at pin PD as short as possible (a few mm only!). This track should be kept away from the IR LED signal tracks and from other sources which may induce unwanted signals. It is strongly recommended to cover the chip, the photodiode and all passive components around the chip with a metal shield. A recommended part is shown in the following figure:

The pins at the bottom are to solder the shield to the PCB with electrical connection to VDD. The hole in the front is the opening window for the photo diode. The back side of the PCB below the sensitive area (D1, C1, R1, epc13x) shall be a polygon connected to VDD to shield the circuit from the back side. C1 must be of high mechanical stability (no piezoelectric effect) in order to avoid unwanted signals by mechanical shock or vibration.

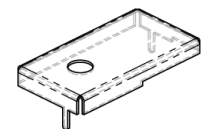

Recommended EMC shield

Ambient Light

Photodiode DC current can be generated by ambient light, e.g. sun light. DC currents at pin PD do not generate an output signal. However, if I_{PDDC} is above the stated value, the input is saturated which blocks the detection of AC current pulses.

Photodiode Capacitance

If the photodiode capacitance is below the specified value, the system becomes more sensitive to power supply ripple voltage at higher frequencies (>200kHz). This sensitivity can be reduced by a parallel capacitor to the photodiode. However, this measure reduces the detection sensitivity. If the photo diode capacity is above the specified value, a lower detection sensitivity and a higher sensitivity spread results.

Layout Information (all measures in mm, )

CSP-6 Package

Mechanical Dimensions

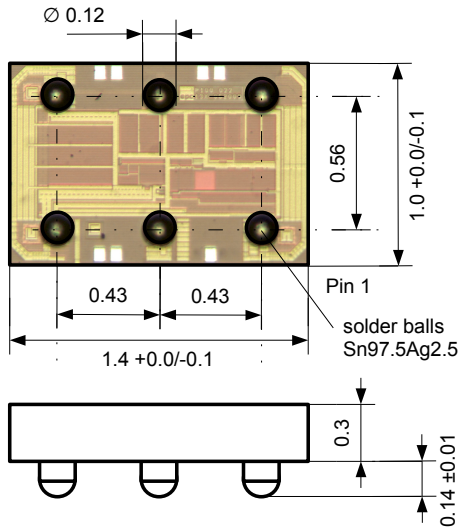

Layout Recommendations

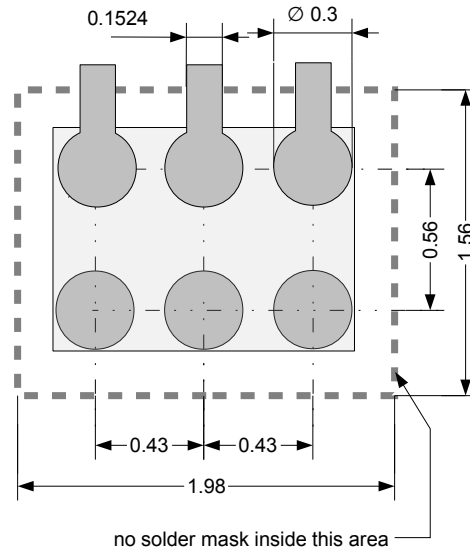

QFN-16 Package

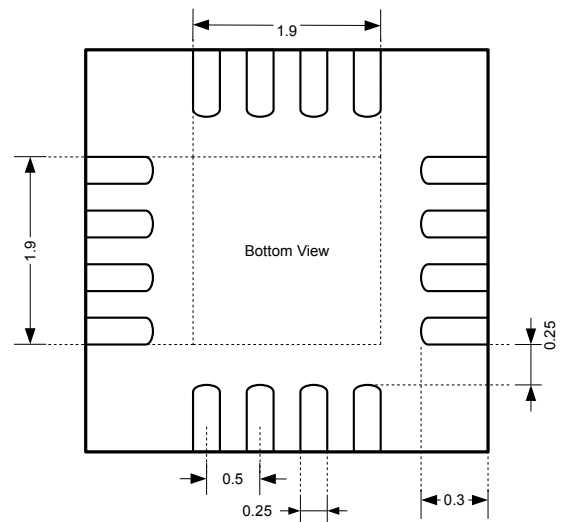
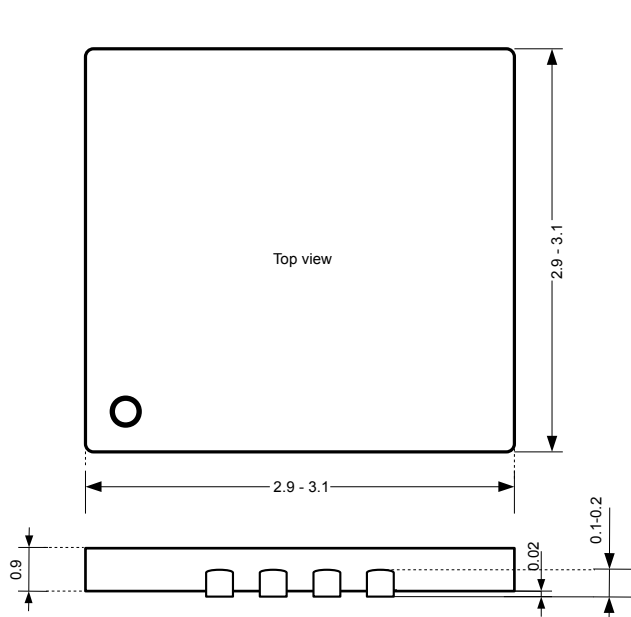

Reflow Solder Profile

For infrared or conventional soldering the solder profile has to follow the recommendations of IPC/JEDEC J-STD-020C (min. revision C) for Pb-free assembly for both types of packages. The peak soldering temperature (T_L) should not exceed +260°C for a maximum of 4 sec.

Packaging Information (all measures in mm)

Tape & Reel Information

The devices are mounted on embossed tape for automatic placement systems. The tape is wound on 178 mm (7 inch) or 330 mm (13 inch) reels and individually packaged for shipment. General tape-and-reel specification data are available in a separate data sheet and indicate the tape sizes for various package types. Further tape-and-reel specifications can be found in the Electronic Industries Association (EIA) standard 481-1, 481-2, 481-3.

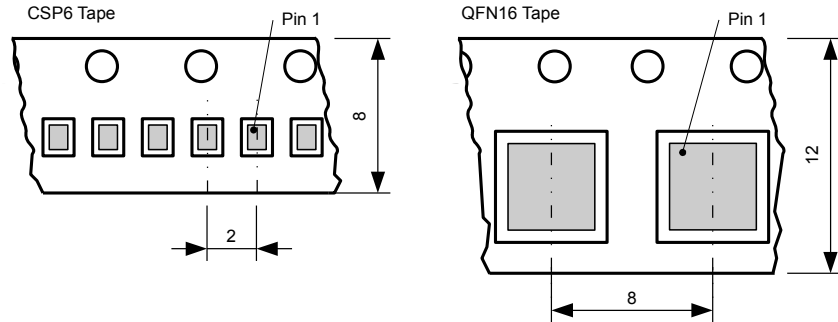

epc does not guarantee that there are no empty cavities.
Thus, the pick-and-place machine should do check the presence of a chip during picking.

Order Information

Part Number	Package	RoHS compliance	Packaging Method
epc134-CSP6	CSP6	Yes	Reel
epc134-QFN16	QFN16	Yes	Reel
epc135-CSP6	CSP6	Yes	Reel
epc135-QFN16	QFN16	Yes	Reel
epc136-CSP6	CSP6	Yes	Reel
epc136-QFN16	QFN16	Yes	Reel
epc137-CSP6	CSP6	Yes	Reel
epc137-QFN16	QFN16	Yes	Reel
epc138-CSP6	CSP6	Yes	Reel
epc138-QFN16	QFN16	Yes	Reel
epc139-CSP6	CSP6	Yes	Reel
epc139-QFN16	QFN16	Yes	Reel

IMPORTANT NOTICE

ESPROS Photonics AG and its subsidiaries (epc) reserve the right to make corrections, modifications, enhancements, improvements, and other changes to its products and services at any time and to discontinue any product or service without notice. Customers should obtain the latest relevant information before placing orders and should verify that such information is current and complete. All products are sold subject to epc's terms and conditions of sale supplied at the time of order acknowledgment.

epc warrants performance of its hardware products to the specifications applicable at the time of sale in accordance with epc's standard warranty. Testing and other quality control techniques are used to the extent epc deems necessary to support this warranty. Except where mandated by government requirements, testing of all parameters of each product is not necessarily performed.

epc assumes no liability for applications assistance or customer product design. Customers are responsible for their products and applications using epc components. To minimize the risks associated with customer products and applications, customers should provide adequate design and operating safeguards.

epc does not warrant or represent that any license, either express or implied, is granted under any epc patent right, copyright, mask work right, or other epc intellectual property right relating to any combination, machine, or process in which epc products or services are used. Information published by epc regarding third-party products or services does not constitute a license from epc to use such products or services or a warranty or endorsement thereof. Use of such information may require a license from a third party under the patents or other intellectual property of the third party, or a license from epc under the patents or other intellectual property of epc.

Resale of epc products or services with statements different from or beyond the parameters stated by epc for that product or service voids all express and any implied warranties for the associated epc product or service. epc is not responsible or liable for any such statements.

epc products are not authorized for use in safety-critical applications (such as life support) where a failure of the epc product would reasonably be expected to cause severe personal injury or death, unless officers of the parties have executed an agreement specifically governing such use. Buyers represent that they have all necessary expertise in the safety and regulatory ramifications of their applications, and acknowledge and agree that they are solely responsible for all legal, regulatory and safety-related requirements concerning their products and any use of epc products in such safety-critical applications, notwithstanding any applications-related information or support that may be provided by epc. Further, Buyers must fully indemnify epc and its representatives against any damages arising out of the use of epc products in such safety-critical applications.

epc products are neither designed nor intended for use in military/aerospace applications or environments unless the epc products are specifically designated by epc as military-grade or "enhanced plastic." Only products designated by epc as military-grade meet military specifications. Buyers acknowledge and agree that any such use of epc products which epc has not designated as military-grade is solely at the Buyer's risk, and that they are solely responsible for compliance with all legal and regulatory requirements in connection with such use.

epc products are neither designed nor intended for use in automotive applications or environments unless the specific epc products are designated by epc as compliant with ISO/TS 16949 requirements. Buyers acknowledge and agree that, if they use any non-designated products in automotive applications, epc will not be responsible for any failure to meet such requirements.