

48 V Input DC-DC Converter Modules



Size:
2.19 x 1.91 x 0.37 in
55,7 x 48,6 x 9,5 mm

Applications

- Communications
- Distributed power
- ATE
- Defense
- Aerospace
- Medical
- And other applications requiring high efficiency

Features

- DC input range: 36 – 75 V
- Efficiency: Up to 93%
- DC output: 1 – 48 V
- Maximum operating temp: 100°C, full load
- Isolated output
- Low noise: Sine Amplitude Converter™ (SAC™) technology
- Highly efficient: ZCS/ZVS switching
- Fast dynamic response
- Low profile: 0.37 in. (9.5 mm)
- RoHS Compliant
- Power density up to 145 W/in³
- Agency approvals

Product Overview

VI Brick DC-DC converters use advanced Sine Amplitude Converter™ (SAC™) technology, thermally enhanced packaging technologies, and advanced CIM processes to provide high power density and efficiency, superior transient response, and improved thermal management. The high speed 3.5 MHz, zero current switching–zero voltage switching (ZCS–ZVS) design enables efficient and low noise operation throughout the operating range.

Product Selection: 36 – 75 V DC Input Range

Output Voltage	Output Power (W)	Current (A)	Efficiency (%)	Part Numbering
1.0 Vdc	100	100	85	DC048B010T010FP
1.5 Vdc	120	80	87	DC048B015T012FP
1.8 Vdc	144	80	89	DC048B018T014FP
2.5 Vdc	175	70	90	DC048B025T017FP
3.0 Vdc	180	60	91	DC048B030T018FP
3.3 Vdc	165	50	91	DC048B033T016FP
5 Vdc	180	36	91	DC048B050T018FP
10 Vdc	180	18	92	DC048B100T018FP
12 Vdc	220	18.33	92	DC048B120T022FP
15 vdc	200	13.33	92	DC048B150T020FP
24 Vdc	220	9.17	92	DC048B240T022FP
28 Vdc	190	6.79	92	DC048B280T019FP
48 Vdc	220	4.58	93	DC048B480T022FP

Part Numbering

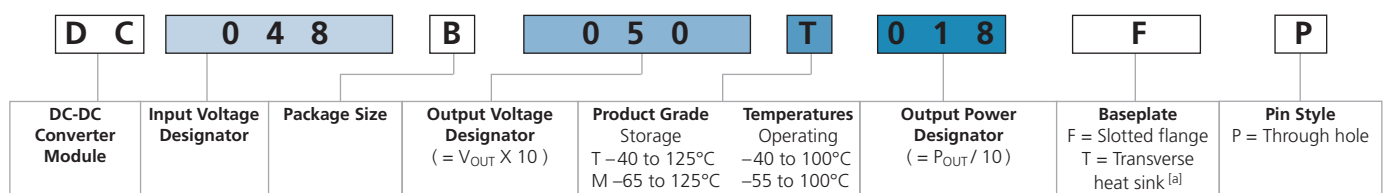

^[a] Contact factory

MODULE FAMILY ELECTRICAL CHARACTERISTICS

Electrical characteristics apply over the full operating range of input voltage, output load (resistive) and baseplate temperature, unless otherwise specified. All temperatures refer to the operating temperature at the center of the baseplate.

Absolute Maximum Ratings			
Parameter	Rating	Unit	Notes
+In to -In voltage	-1.0 to +85	Vdc	
PC to -In voltage	-0.3 to +6.0	Vdc	
+Out to -Out			
1.0 V	-0.5 to 4.0	Vdc	
1.5 V	-0.5 to 4.0	Vdc	
1.8 V	-0.5 to 4.0	Vdc	
2.5 V	-0.5 to 6.0	Vdc	
3.0 V	-0.5 to 6.0	Vdc	
3.3 V	-0.5 to 12.0	Vdc	
5 V	-0.5 to 12.0	Vdc	
10 V	-0.5 to 30.0	Vdc	
12 V	-0.5 to 30.0	Vdc	
15 V	-0.5 to 25	Vdc	
24 V	-0.5 to 50.0	Vdc	
28 V	-0.5 to 48.0	Vdc	
48 V	-0.5 to 60.0	Vdc	
Isolation voltage			
In to out	2,250	Vdc	Test voltage
In to base	2,250	Vdc	Test voltage
Out to base	707	Vdc	Test voltage
Operating Temperature	-55 to +100	°C	M-Grade
Storage Temperature	-65 to +125	°C	M-Grade
Pin soldering temperature	500 (260)	°F (°C)	<5 sec; wave solder
	750 (390)	°F (°C)	<7 sec; hand solder
Mounting torque	5 (0.57)	in-lbs (N-m)	6 each

Note: Stresses in excess of the maximum ratings can cause permanent damage to the device. Operation of the device is not implied at these or any other conditions in excess of those given in the specification. Exposure to absolute maximum ratings can adversely affect device reliability.

Input Specifications					
Parameter	Min	Typ	Max	Unit	Notes
Operating input voltage	36	48	75	Vdc	
Input surge withstand			85	Vdc	
Undervoltage turn-on		33.8	35.3	Vdc	
Undervoltage turn-off	30.4	31.8		Vdc	
Overvoltage turn-on	75.7	77.3		Vdc	
Overvoltage turn-off		78.8	81.0	Vdc	
Recommended external input capacitance		100		μF	See Figure 19

Output Specifications^[a]

Parameter	Min	Typ	Max	Unit	Notes
Output voltage setpoint		2%		Vout nom.	Nominal input; full load; 25°C
Line regulation		±0.5	±1	%	Low line to high line; full load, deviation from setpoint
Temperature regulation		±0.03	.05	% / °C	Over operating temperature range

^[a] For important information relative to applications where the converter modules are subject to continuous dynamic loading, contact Vicor applications engineering at 800-927-9474.

Control Specifications

Parameter	Min	Typ	Max	Unit	Notes
Primary Control (PC)					
DC voltage	4.8	5.0	5.2	Vdc	Referenced to -In
Module disable voltage	2.3	2.4		Vdc	Referenced to -In
Module enable voltage		2.5	2.6	Vdc	Referenced to -In
Disable hysteresis		100		mV	
Current limit		1.75	1.90	mA	
Disable delay time		1		µs	

Thermal Resistance and Capacity

Parameter	Min	Typ	Max	Unit
Baseplate to sink; flat, greased surface		0.20		°C/Watt
Baseplate to sink; thermal pad		0.18		°C/Watt
Baseplate to ambient		6.5		°C/Watt
Baseplate to ambient; 1000 LFM		2.0		°C/Watt
Thermal capacity		47.7		Watt-sec/°C

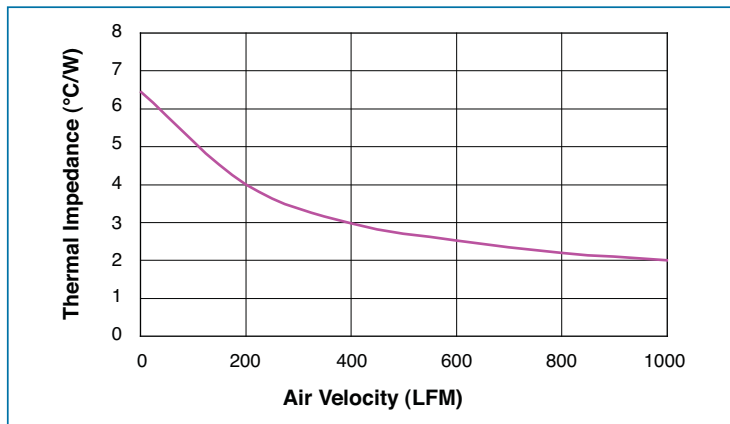

Figure 1 – Thermal impedance vs. airflow

General Specifications					
Parameter	Min	Typ	Max	Unit	Notes
Isolation voltage	In to out	2,250		Vdc	Test voltage, complies with basic insulation requirements
	In to base	2,250		Vdc	Test voltage, complies with basic insulation requirements
	Out to base	707		Vdc	Test voltage, complies with operational insulation requirements
Isolation resistance (in to out)		10		megohms	
Weight		2.19		ounces	
			62.14	grams	
Thermal protection	125	130	135	°C	Junction temperature, with automatic recovery
Agency approvals		cTÜVus, CE			UL60950-1, CSA0950-1, EN60950-1, IEC60950-1. With appropriate fuse in series with the +Input

Note: Specifications are subject to change without notice.

1.0 Vout, 100 W OPERATING SPECIFICATIONS - (e.g. DC048B010T010FP)

Parameter	Min	Typ	Max	Unit	Notes
Efficiency	82	85		%	Nominal input; full load; 25°C
Ripple and noise		100	138	mV	p-p; Nominal input; full load; 20 MHz bandwidth
Output OVP setpoint	1.17		1.24	Volts	25°C; recycle input voltage to restart (1 minute off)
Dissipation, standby		5.5	7.6	Watts	No load
Load regulation		±0.6	±1.5	%	No load to full load; nominal input, deviation from setpoint
Output capacitance			108,000	µF	External
Load current	0		100	Amps	
Current limit (peak)	108	115	130	Amps	Shut down, may require PC enable to initiate restart
Short circuit current (avg)	0	1.0	50	Amps	Shut down, may require PC enable to initiate restart

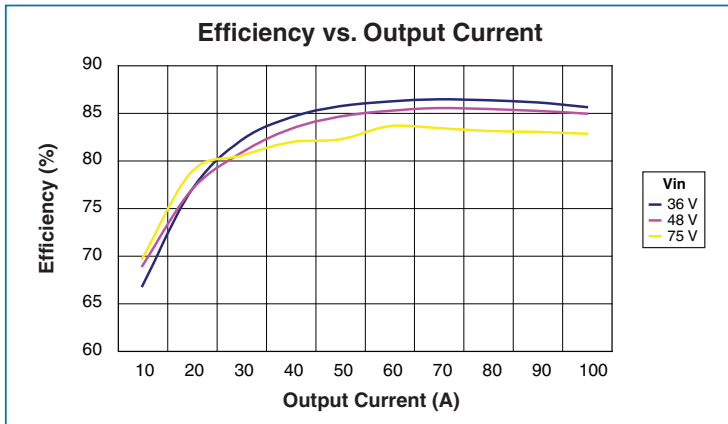

Figure 2-1 – Efficiency vs. load

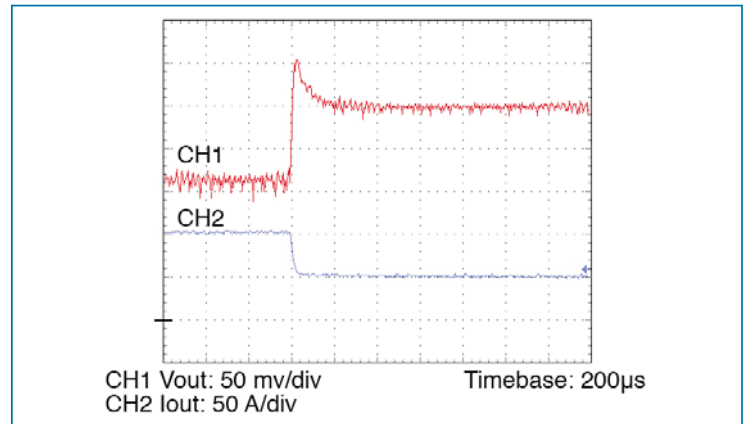

Figure 2-4 – Transient response 100 – 50%, 3 x 4.7 µF ceramic bypass capacitance

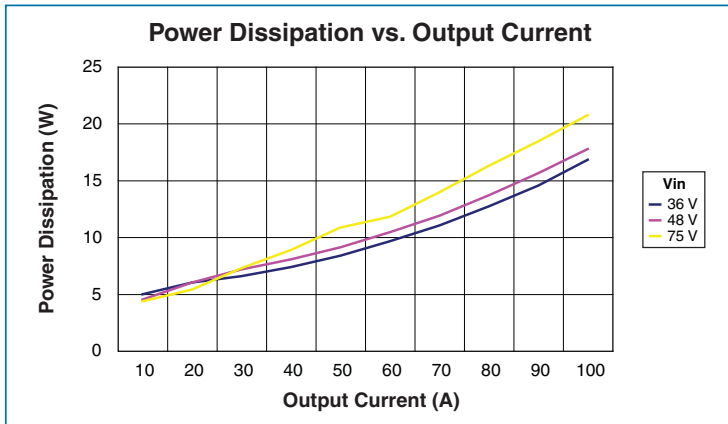

Figure 2-2 – Power dissipation vs. load

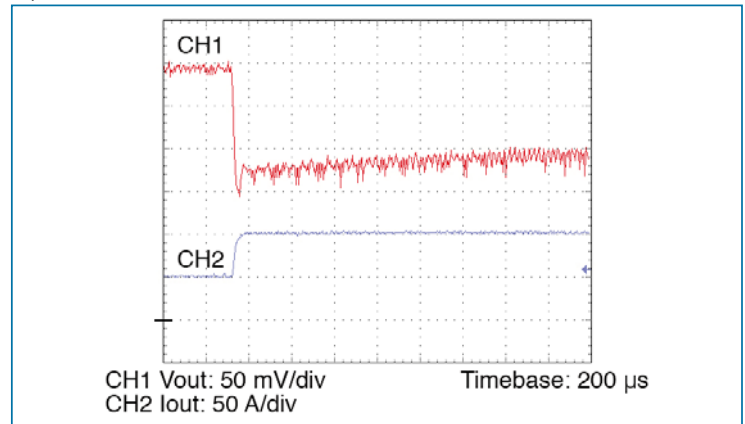

Figure 2-5 – Transient response 50 – 100%, 3 x 4.7 µF ceramic bypass capacitance

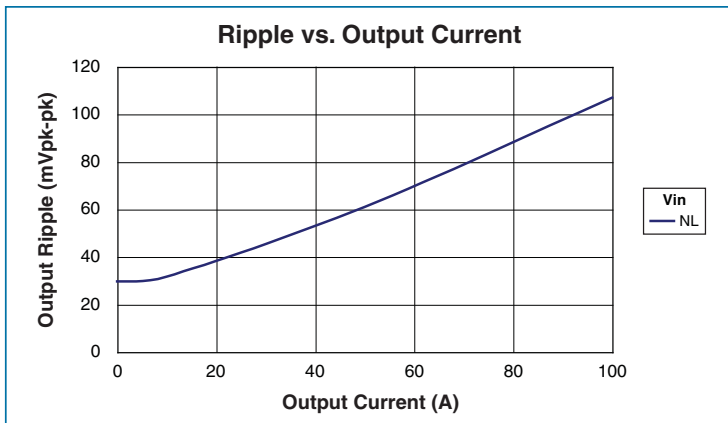

Figure 2-3 – Output ripple vs. load with no external bypass capacitance

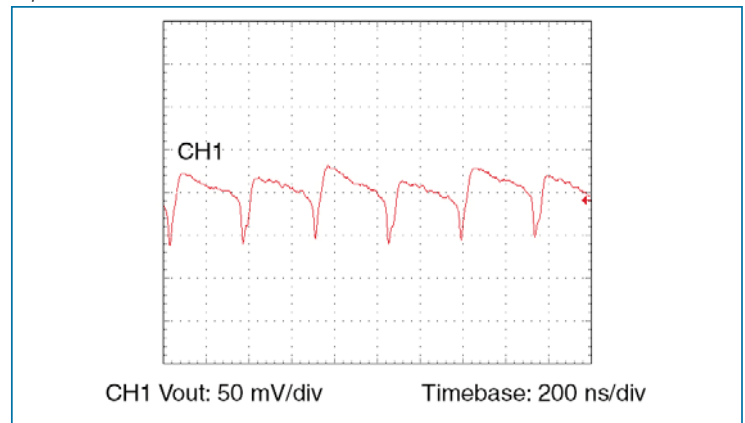

Figure 2-6 – Output voltage ripple at nominal line and full load with no external bypass capacitance.

1.5 Vout, 120 W OPERATING SPECIFICATIONS - (e.g. DC048B015T012FP)

Parameter	Min	Typ	Max	Unit	Notes
Efficiency	83	87		%	Nominal input; full load; 25°C
Ripple and noise		100	125	mV	p-p; Nominal input; full load; 20 MHz bandwidth
Output OVP setpoint	1.75		1.86	Volts	25°C; recycle input voltage to restart (1 minute off)
Dissipation, standby		5.5	7.6	Watts	No load
Load regulation		±0.6	±1.5	%	No load to full load; nominal input, deviation from setpoint
Output capacitance			48,000	µF	External
Load current	0		80	Amps	
Current limit (peak)	86.4	92	104	Amps	Shut down, may require PC enable to initiate restart
Short circuit current (avg)	0	1.0	40	Amps	Shut down, may require PC enable to initiate restart

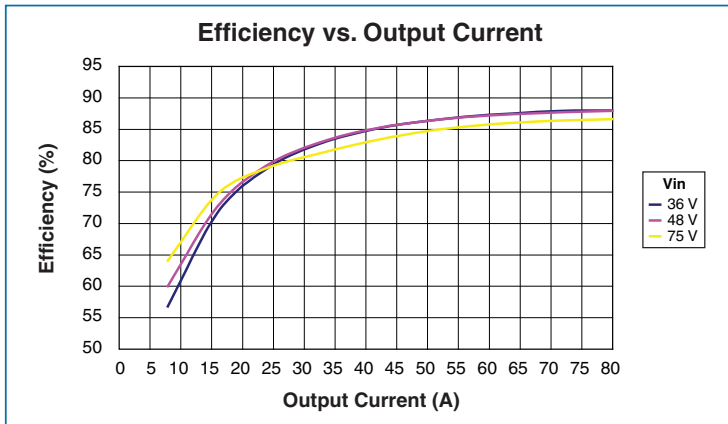

Figure 3-1 – Efficiency vs. load

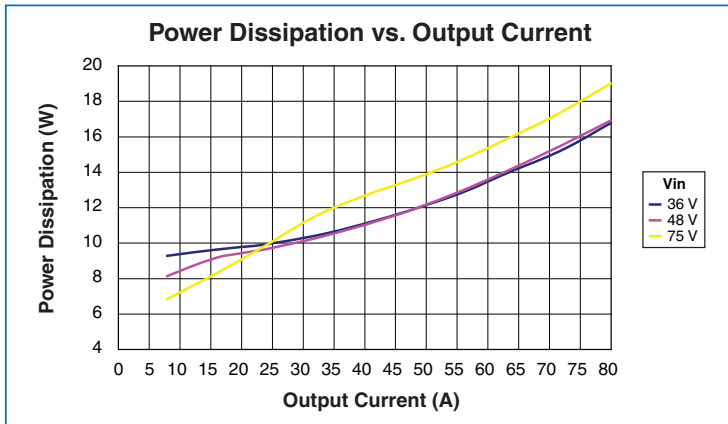

Figure 3-2 – Power dissipation vs. load

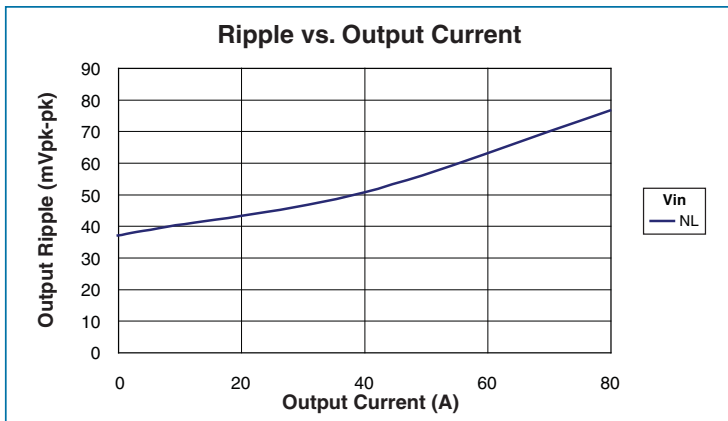

Figure 3-3 – Output ripple vs. load with no external bypass capacitance

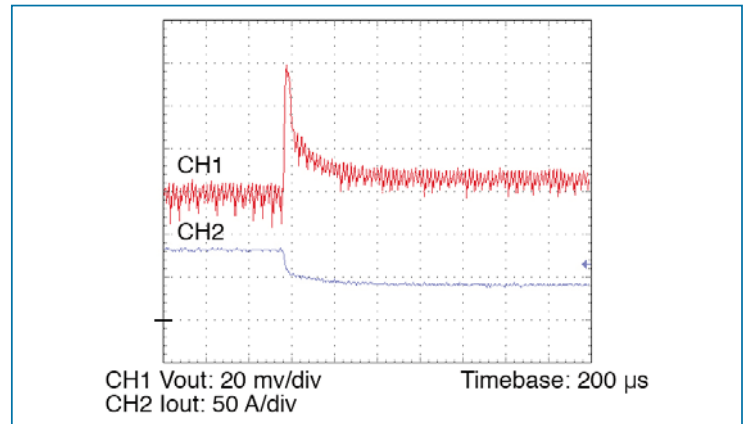

Figure 3-4 – Transient response 100 – 50%, 3 x 4.7 µF ceramic bypass capacitance

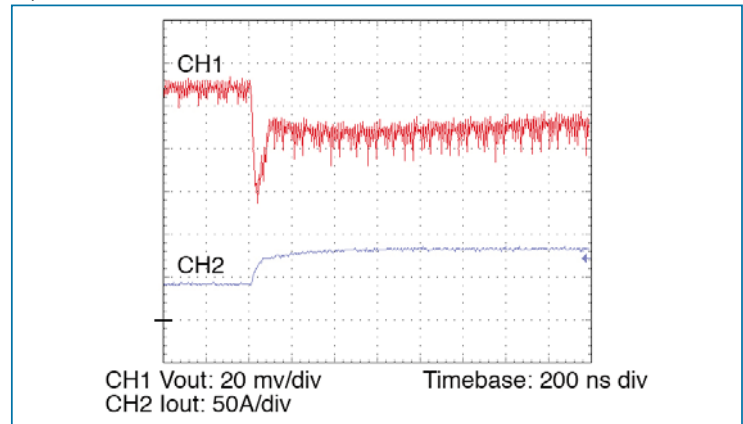

Figure 3-5 – Transient response 50 – 100%, 3 x 4.7 µF ceramic bypass capacitance

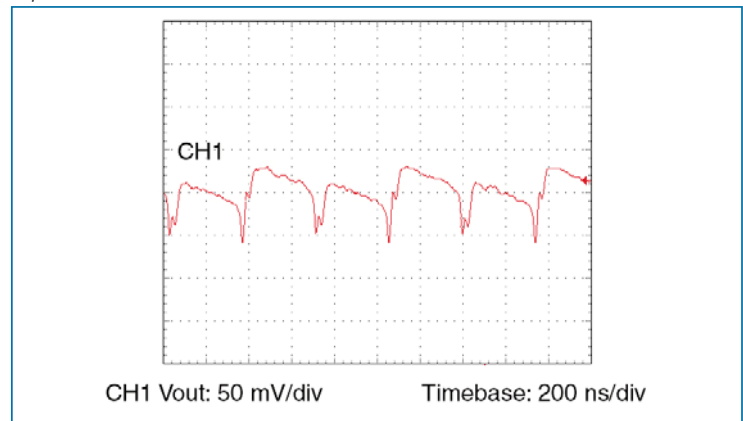

Figure 3-6 – Output voltage ripple at nominal line and full load with no external bypass capacitance.

1.8 Vout, 144 W OPERATING SPECIFICATIONS - (e.g. DC048B018T014FP)

Parameter	Min	Typ	Max	Unit	Notes
Efficiency	86	89		%	Nominal input; full load; 25°C
Ripple and noise		87	109	mV	p-p; Nominal input; full load; 20 MHz bandwidth
Output OVP setpoint	2.33		2.48	Volts	25°C; recycle input voltage to restart (1 minute off)
Dissipation, standby		5.5	7.6	Watts	No load
Load regulation		±0.6	±1.5	%	No load to full load; nominal input, deviation from setpoint
Output capacitance			27,000	µF	External
Load current	0		80	Amps	
Current limit (peak)	86.4	92	104	Amps	Shut down, may require PC enable to initiate restart
Short circuit current (avg)	0	1.0	40	Amps	Shut down, may require PC enable to initiate restart

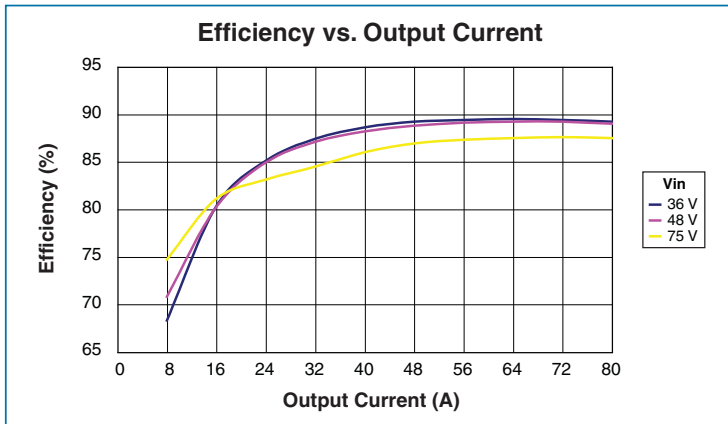

Figure 4-1 – Efficiency vs. load

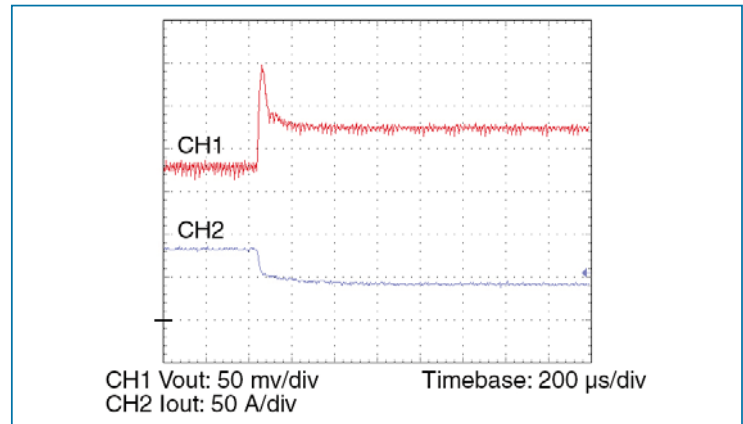

Figure 4-4 – Transient response 100 – 50%, 3 x 4.7 µF ceramic bypass capacitance

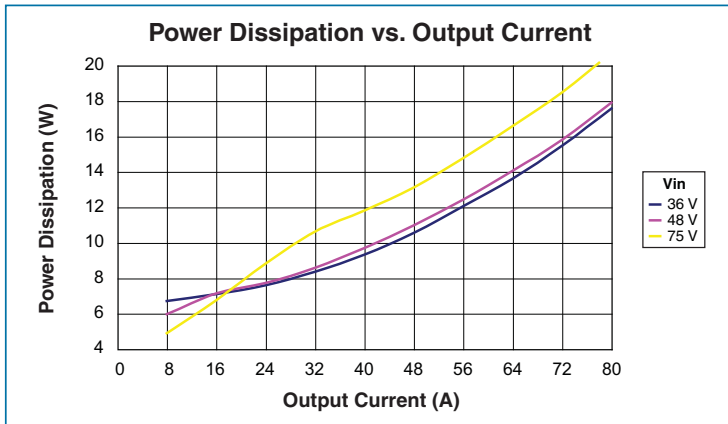

Figure 4-2 – Power dissipation vs. load

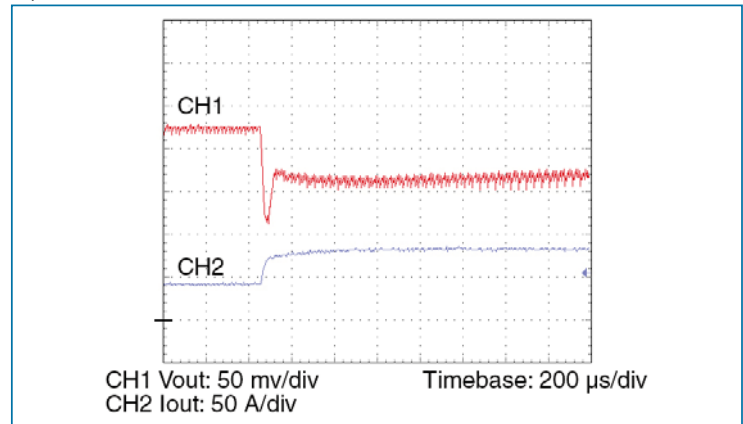

Figure 4-5 – Transient response 50 – 100%, 3 x 4.7 µF ceramic bypass capacitance

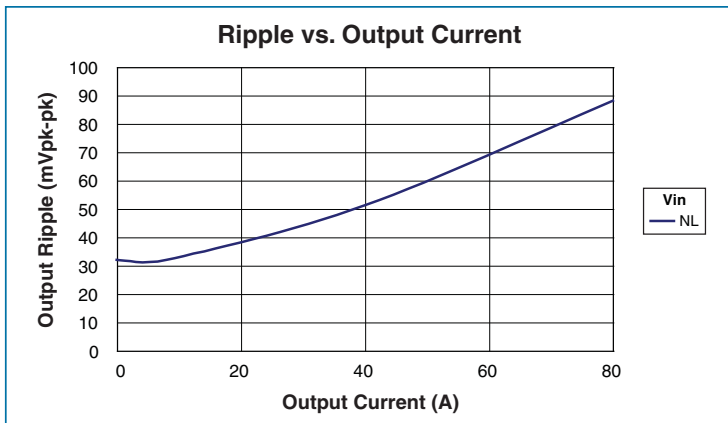

Figure 4-3 – Output ripple vs. load with no external bypass capacitance

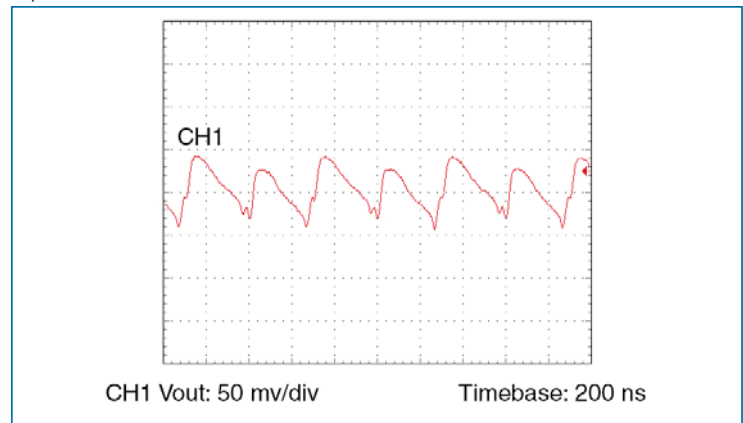

Figure 4-6 – Output voltage ripple at nominal line and full load with no external bypass capacitance.

2.5 Vout, 175 W OPERATING SPECIFICATIONS - (e.g. DC048B025T017FP)

Parameter	Min	Typ	Max	Unit	Notes
Efficiency	87	90		%	Nominal input; full load; 25°C
Ripple and noise		65	95	mV	p-p; Nominal input; full load; 20 MHz bandwidth
Output OVP setpoint	3.5		3.71	Volts	25°C; recycle input voltage to restart (1 minute off)
Dissipation, standby		5.5	7.6	Watts	No load
Load regulation		±0.6	±1.5	%	No load to full load; nominal input, deviation from setpoint
Output capacitance			12,000	µF	External
Load current	0		70	Amps	
Current limit (peak)	75.6	80.5	91	Amps	Shut down, may require PC enable to initiate restart
Short circuit current (avg)	0	1.0	35	Amps	Shut down, may require PC enable to initiate restart

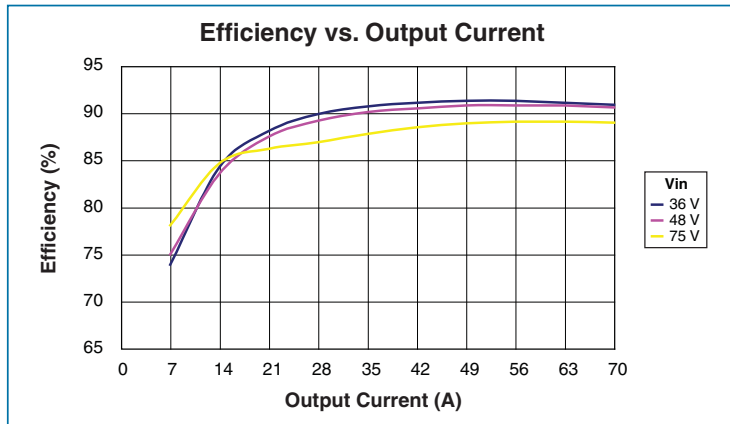

Figure 5-1 – Efficiency vs. load

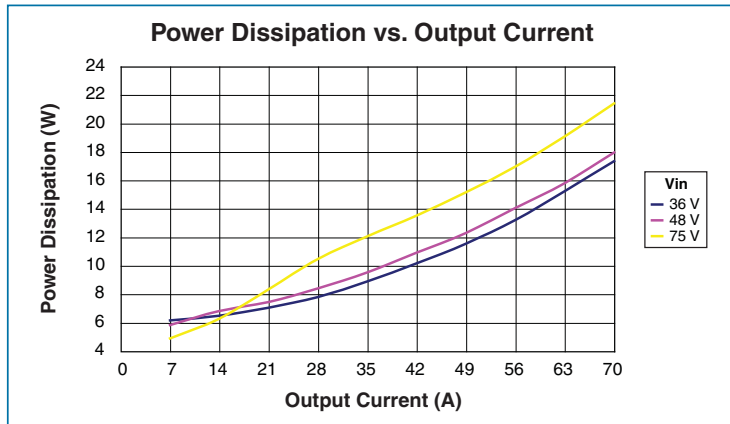

Figure 5-2 – Power dissipation vs. load

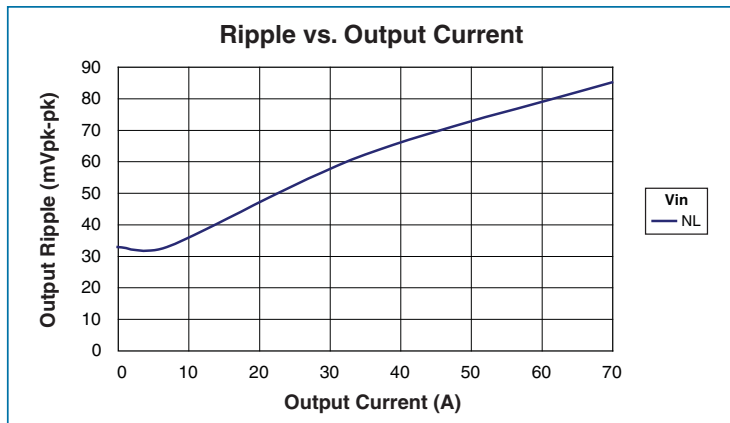

Figure 5-3 – Output ripple vs. load with no external bypass capacitance

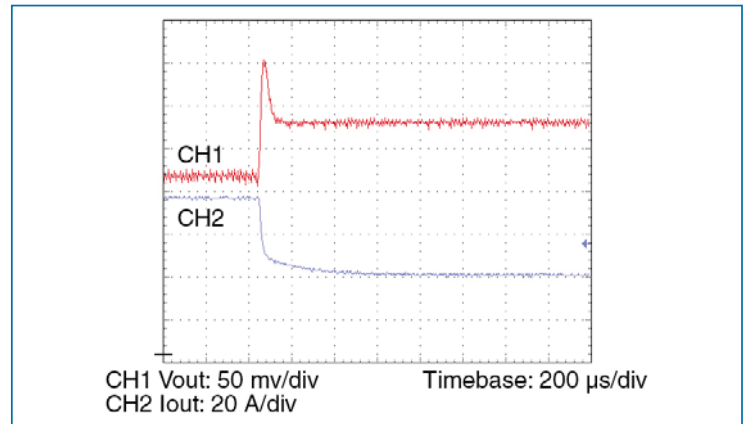

Figure 5-4 – Transient response 100 – 50%, 3 x 4.7 µF ceramic bypass capacitance

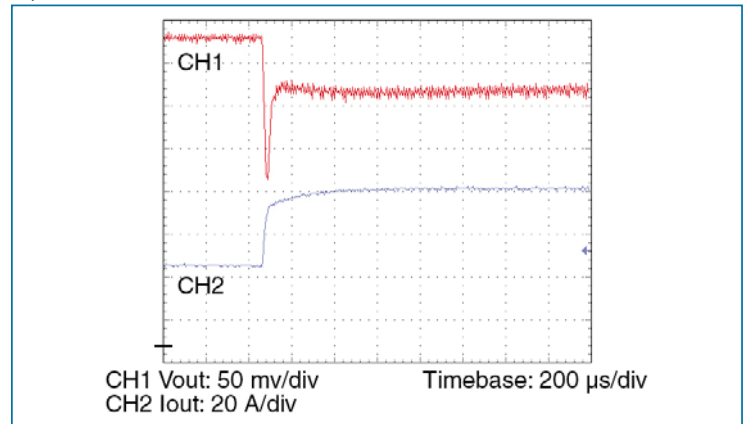

Figure 5-5 – Transient response 50 – 100%, 3 x 4.7 µF ceramic bypass capacitance

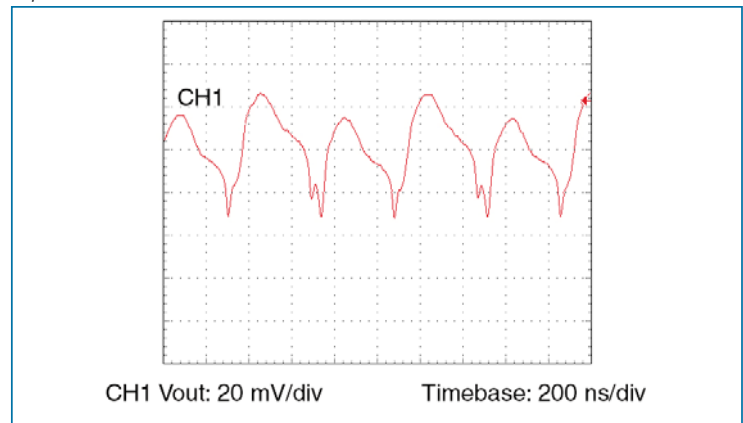

Figure 5-6 – Output voltage ripple at nominal line and full load with no external bypass capacitance.

3.0 Vout, 180 W OPERATING SPECIFICATIONS - (e.g. DC048B030T018FP)

Parameter	Min	Typ	Max	Unit	Notes
Efficiency	88	91		%	Nominal input; full load; 25°C
Ripple and noise		56	90	mV	p-p; Nominal input; full load; 20 MHz bandwidth
Output OVP setpoint	3.5		3.71	Volts	25°C; recycle input voltage to restart (1 minute off)
Dissipation, standby		5.5	7.6	Watts	No load
Load regulation		±0.6	±1.5	%	No load to full load; nominal input, deviation from setpoint
Output capacitance			12,000	µF	External
Load current	0		60	Amps	
Current limit (peak)	64.8	69.0	78.0	Amps	Shut down, may require PC enable to initiate restart
Short circuit current (avg)	0	1.0	30	Amps	Shut down, may require PC enable to initiate restart

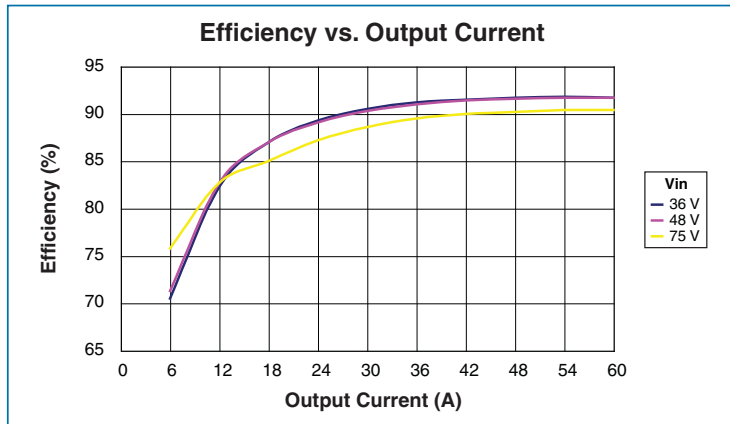

Figure 6-1 – Efficiency vs. load

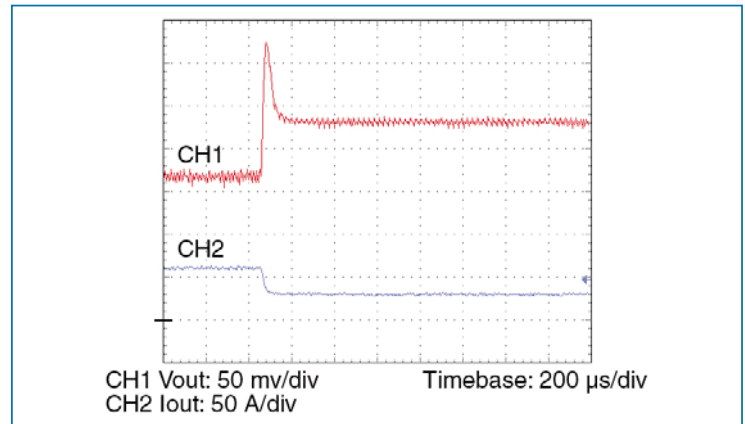

Figure 6-4 – Transient response 100 – 50%, 3 x 4.7 µF ceramic bypass capacitance

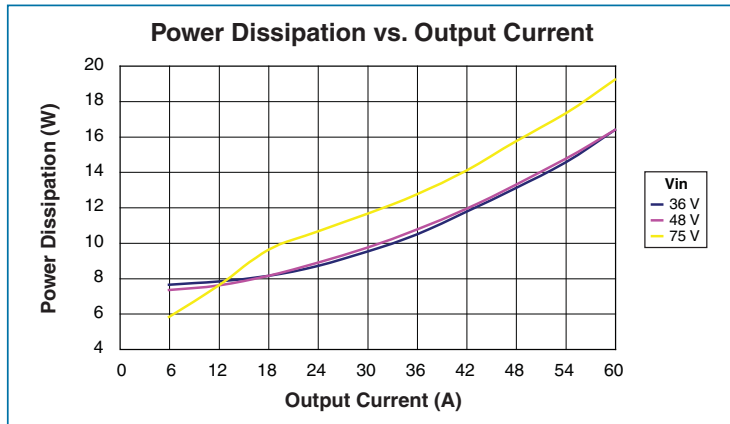

Figure 6-2 – Power dissipation vs. load

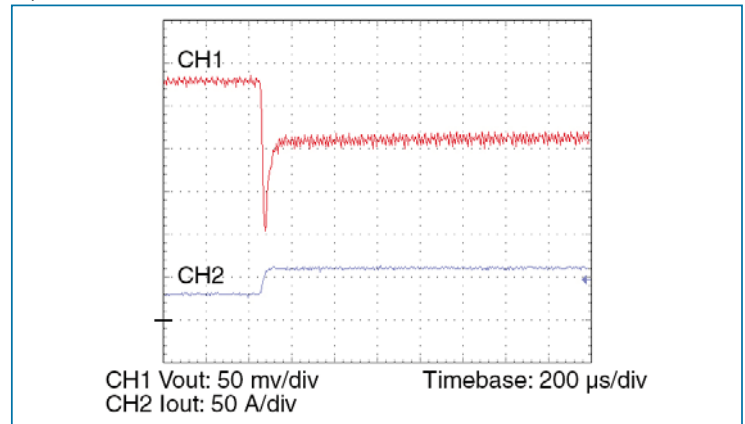

Figure 6-5 – Transient response 50 – 100%, 3 x 4.7 µF ceramic bypass capacitance

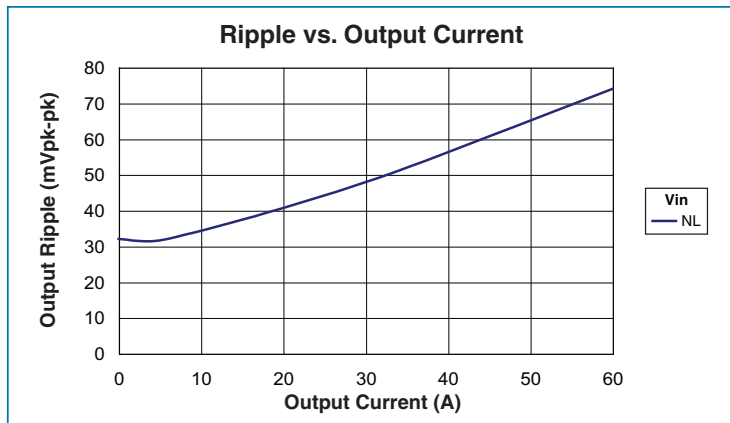

Figure 6-3 – Output ripple vs. load with no external bypass capacitance

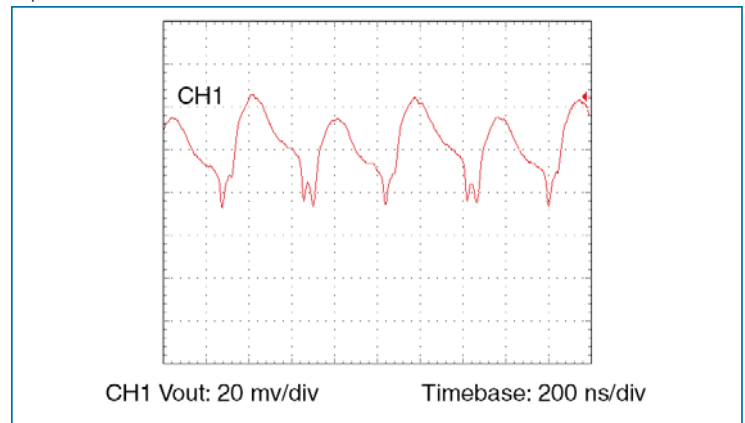

Figure 6-6 – Output voltage ripple at nominal line and full load with no external bypass capacitance.

3.3 Vout, 165 W OPERATING SPECIFICATIONS - (e.g. DC048B033T016FP)

Parameter	Min	Typ	Max	Unit	Notes
Efficiency	87	91		%	Nominal input; full load; 25°C
Ripple and noise		130	163	mV	p-p; Nominal input; full load; 20 MHz bandwidth
Output OVP setpoint	4.67		4.95	Volts	25°C; recycle input voltage to restart (1 minute off)
Dissipation, standby		5.5	7.6	Watts	No load
Load regulation		±0.6	±1.5	%	No load to full load; nominal input, deviation from setpoint
Output capacitance			6,700	µF	External
Load current	0		50	Amps	
Current limit (peak)	54.0	57.5	65	Amps	Shut down, may require PC enable to initiate restart
Short circuit current (avg)	0	1.0	25	Amps	Shut down, may require PC enable to initiate restart

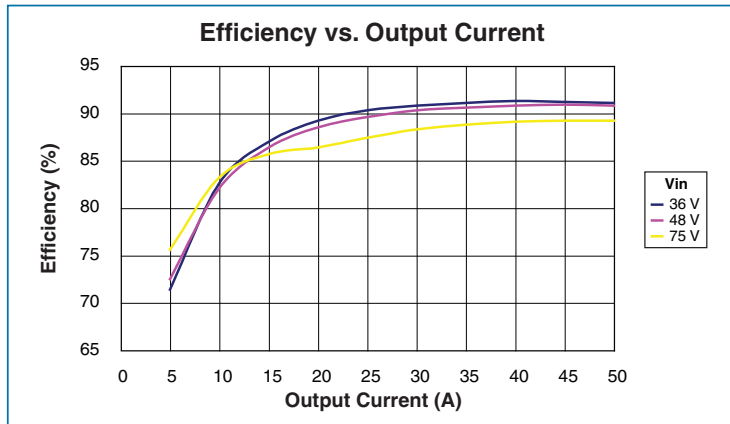

Figure 7-1 – Efficiency vs. load

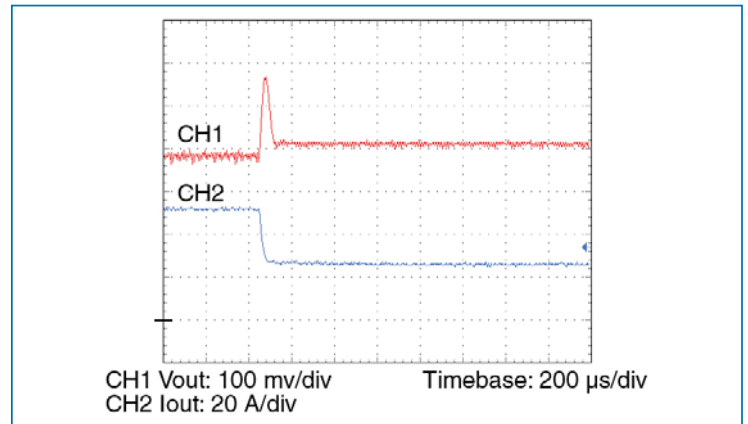

Figure 7-4 – Transient response 100 – 50%, 3 x 4.7 µF ceramic bypass capacitance

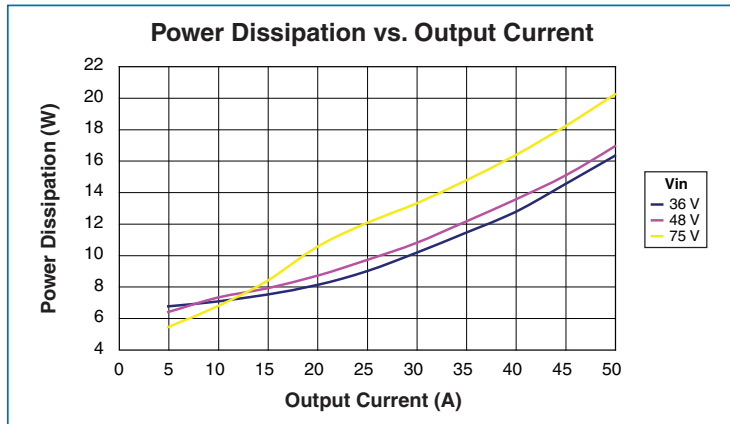

Figure 7-2 – Power dissipation vs. load

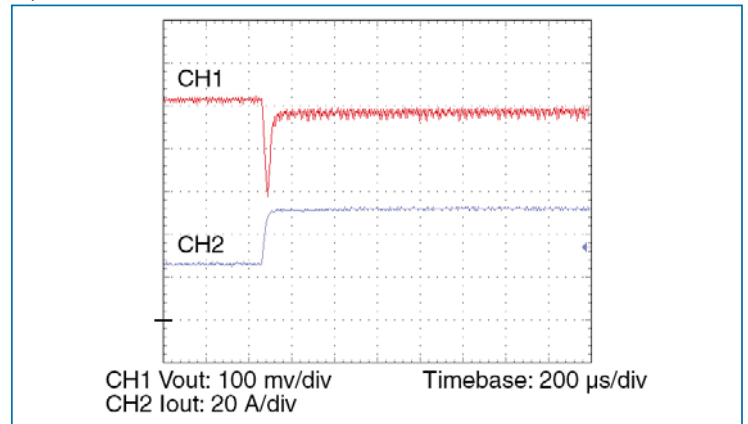

Figure 7-5 – Transient response 50 – 100%, 3 x 4.7 µF ceramic bypass capacitance

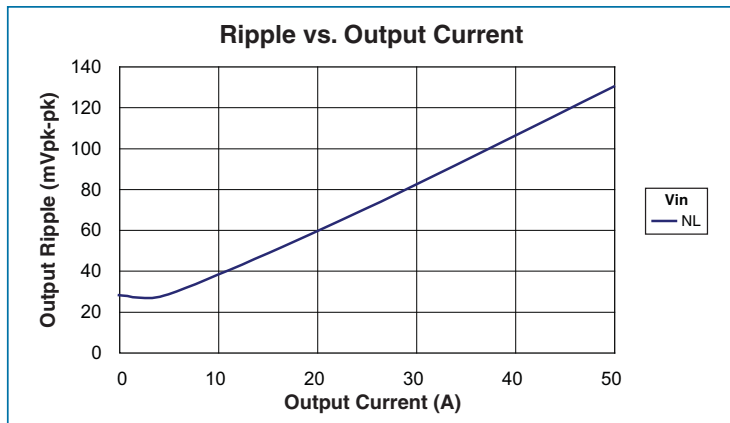

Figure 7-3 – Output ripple vs. load with no external bypass capacitance

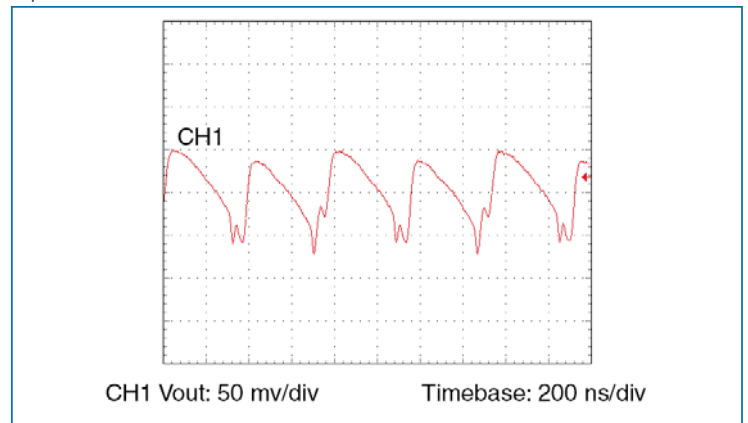

Figure 7-6 – Output voltage ripple at nominal line and full load with no external bypass capacitance.

5.0 Vout, 180 W OPERATING SPECIFICATIONS - (e.g. DC048B050T018FP)

Parameter	Min	Typ	Max	Unit	Notes
Efficiency	88	91		%	Nominal input; full load; 25°C
Ripple and noise		130	165	mV	p-p; Nominal input; full load; 20 MHz bandwidth
Output OVP setpoint	7.0		7.43	Volts	25°C; recycle input voltage to restart (1 minute off)
Dissipation, standby		5.5	7.6	Watts	No load
Load regulation		±0.6	±1.5	%	No load to full load; nominal input, deviation from setpoint
Output capacitance			3,000	µF	External
Load current	0		36	Amps	
Current limit (peak)	38.88	41.4	46.8	Amps	Shut down, may require PC enable to initiate restart
Short circuit current (avg)	0	1.0	18.0	Amps	Shut down, may require PC enable to initiate restart

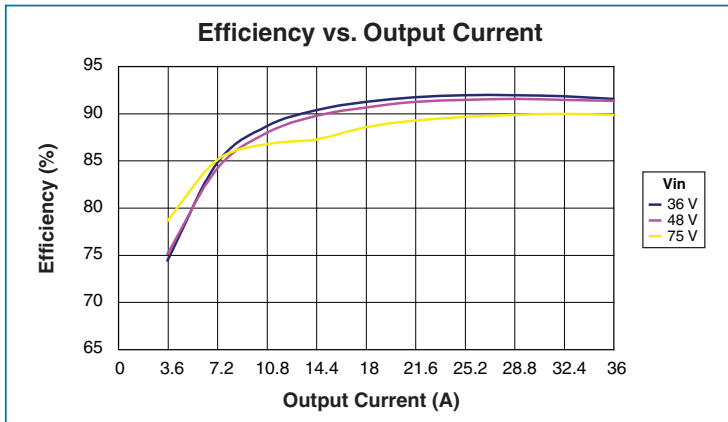

Figure 8-1 – Efficiency vs. load

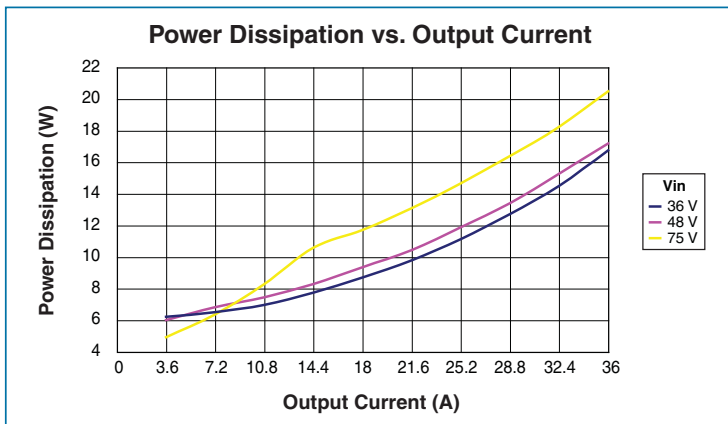

Figure 8-2 – Power dissipation vs. load

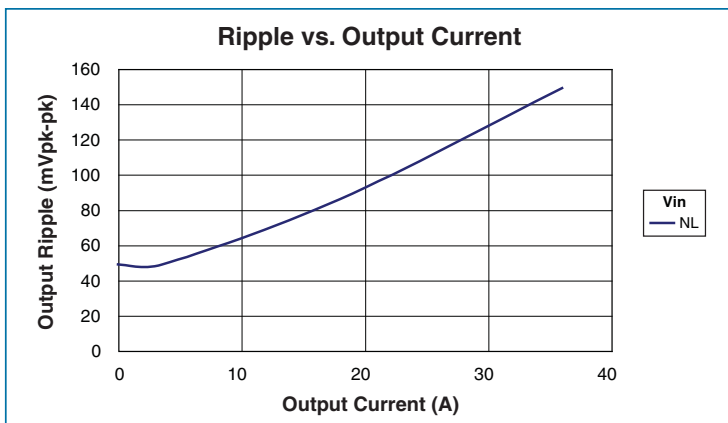

Figure 8-3 – Output ripple vs. load with no external bypass capacitance

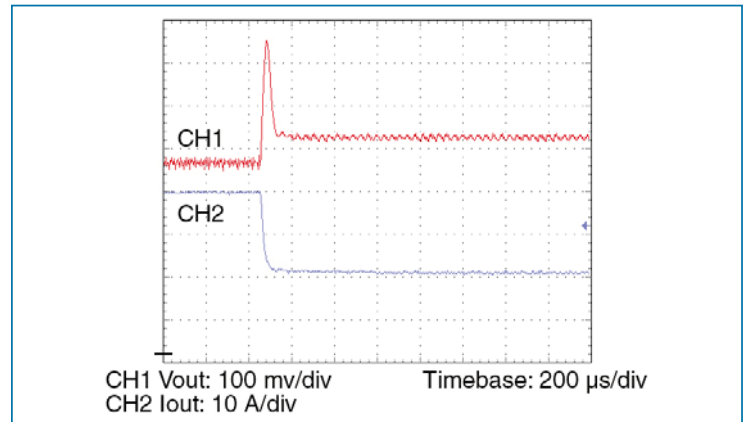

Figure 8-4 – Transient response 100 – 50%, 3 x 4.7 µF ceramic bypass capacitance

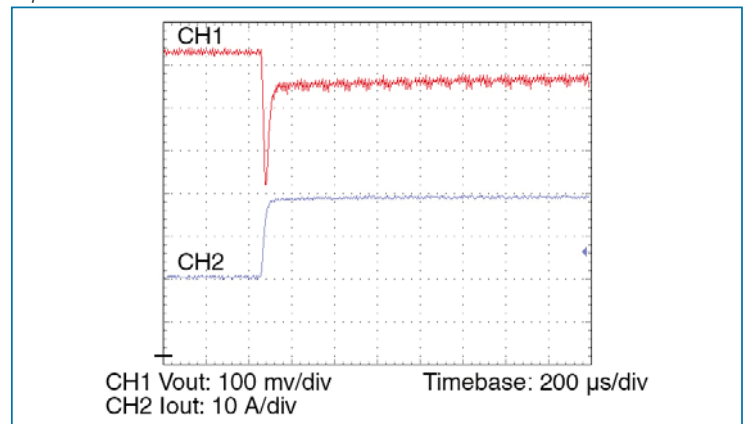

Figure 8-5 – Transient response 50 – 100%, 3 x 4.7 µF ceramic bypass capacitance

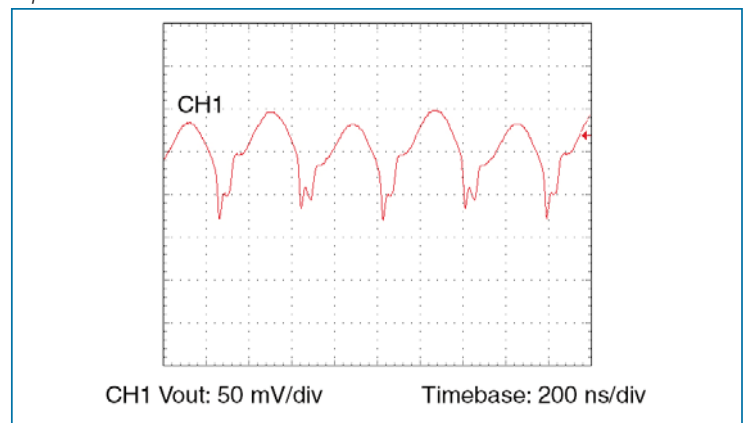

Figure 8-6 – Output voltage ripple at nominal line and full load with no external bypass capacitance.

10 Vout, 180 W OPERATING SPECIFICATIONS - (e.g. DC048B100T018FP)

Parameter	Min	Typ	Max	Unit	Notes
Efficiency	89	92		%	Nominal input; full load; 25°C
Ripple and noise		80	125	mV	p-p; Nominal input; full load; 20 MHz bandwidth
Output OVP setpoint	14.0		14.85	Volts	25°C; recycle input voltage to restart (1 minute off)
Dissipation, standby		5.5	7.6	Watts	No load
Load regulation		±0.6	±1.5	%	No load to full load; nominal input, deviation from setpoint
Output capacitance			750	µF	External
Load current	0		18	Amps	
Current limit (peak)	19.44	20.7	23.4	Amps	Shut down, may require PC enable to initiate restart
Short circuit current (avg)	0	1.0	9.0	Amps	Shut down, may require PC enable to initiate restart

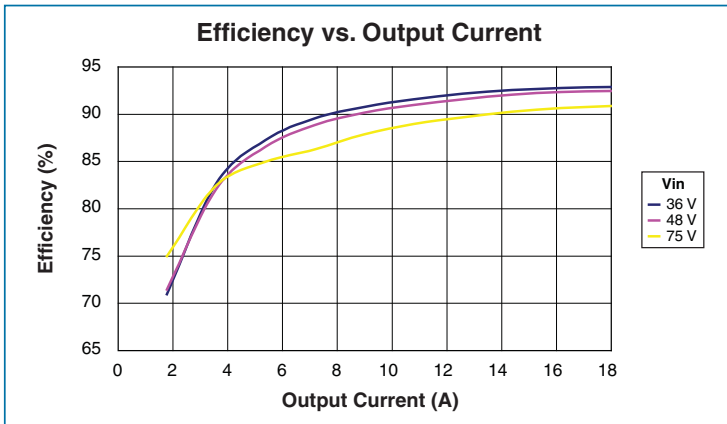

Figure 9-1 – Efficiency vs. load

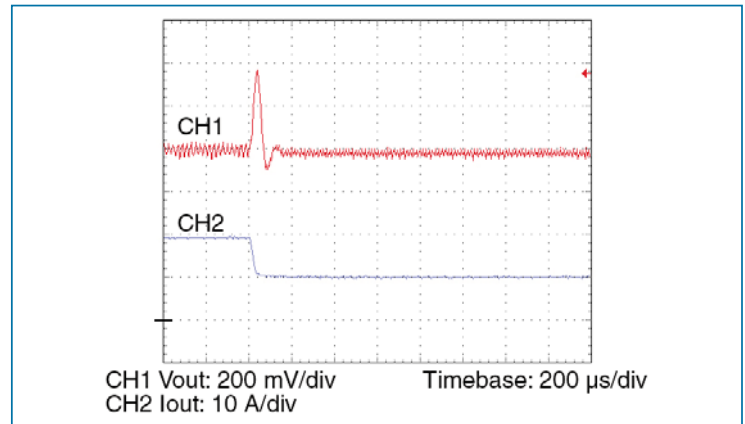

Figure 9-4 – Transient response 100 – 50%, 3 x 4.7 µF ceramic bypass capacitance

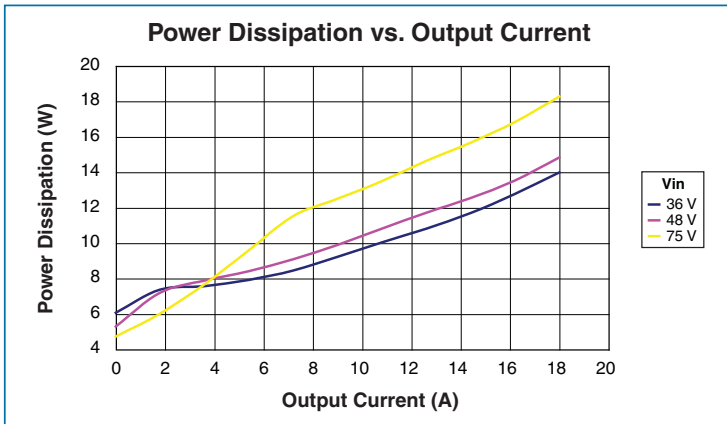

Figure 9-2 – Power dissipation vs. load

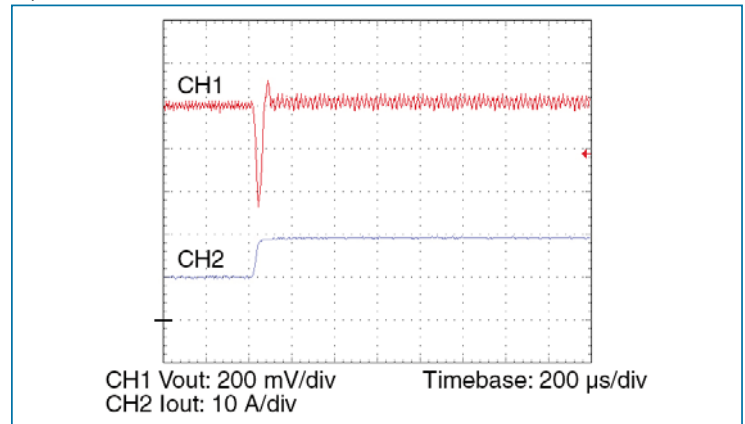

Figure 9-5 – Transient response 50 – 100%, 3 x 4.7 µF ceramic bypass capacitance

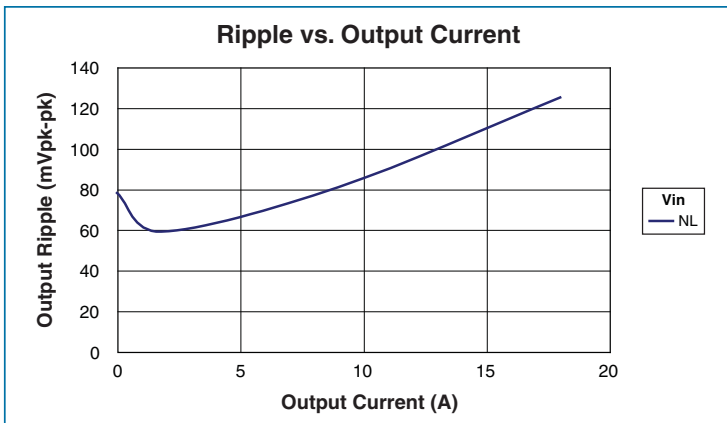

Figure 9-3 – Output ripple vs. load with no external bypass capacitance

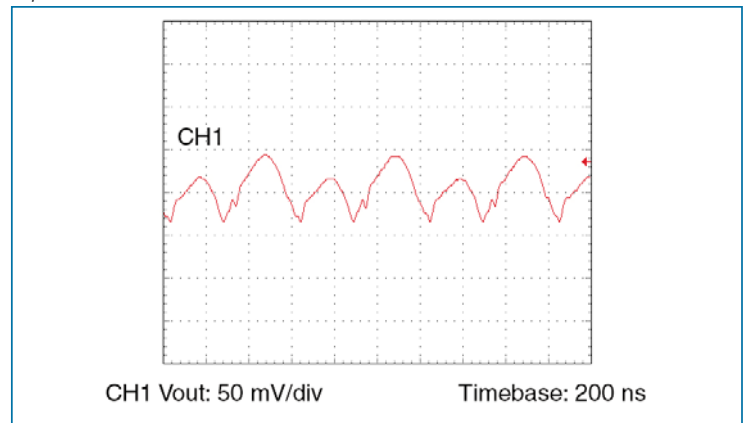

Figure 9-6 – Output voltage ripple at nominal line and full load with no external bypass capacitance.

12 Vout, 220 W OPERATING SPECIFICATIONS - (e.g. DC048B120T022FP)

Parameter	Min	Typ	Max	Unit	Notes
Efficiency	87	92		%	Nominal input; full load; 25°C
Ripple and noise		160	200	mV	p-p; Nominal input; full load; 20 MHz bandwidth
Output OVP setpoint	14.0		14.85	Volts	25°C; recycle input voltage to restart (1 minute off)
Dissipation, standby		5.5	7.6	Watts	No load
Load regulation		±0.6	±1.5	%	No load to full load; nominal input, deviation from setpoint
Output capacitance			750	µF	External
Load current	0		18.33	Amps	
Current limit (peak)	19.80	21.08	23.83	Amps	Shut down, may require PC enable to initiate restart
Short circuit current (avg)	0	1.0	9.17	Amps	Shut down, may require PC enable to initiate restart

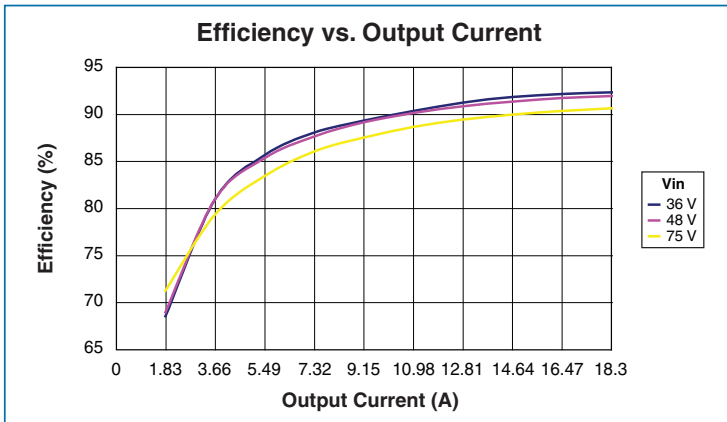

Figure 10-1 – Efficiency vs. load

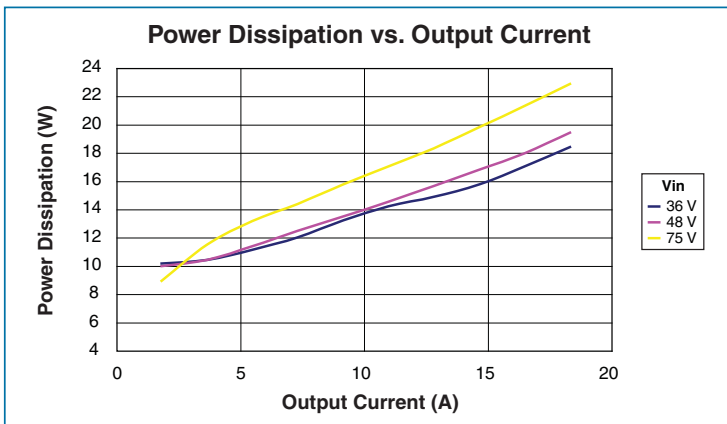

Figure 10-2 – Power dissipation vs. load

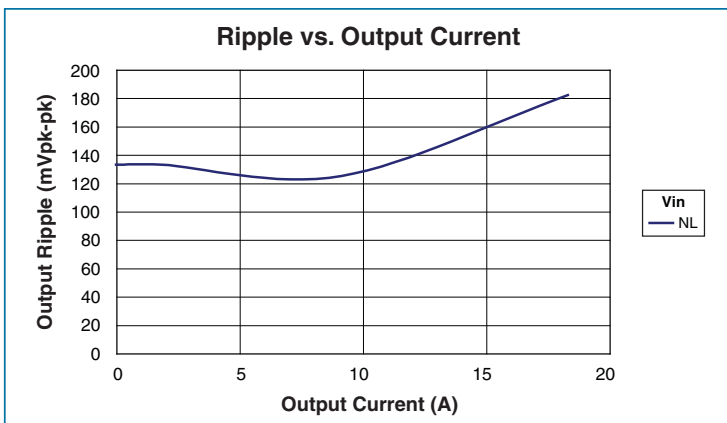

Figure 10-3 – Output ripple vs. load with no external bypass capacitance

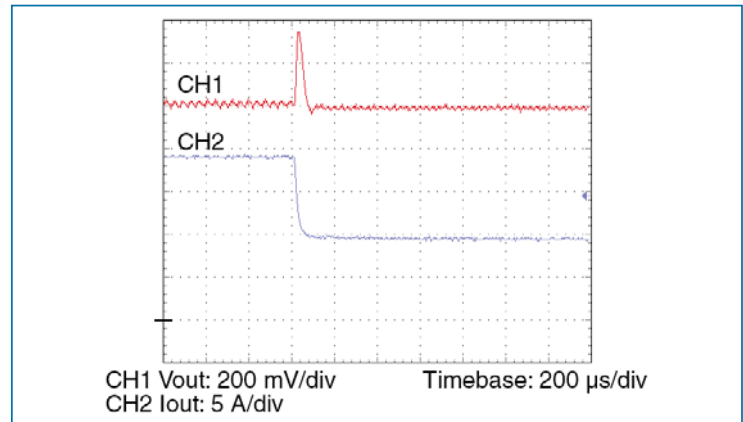

Figure 10-4 – Transient response 100 – 50%, 3 x 4.7 µF ceramic bypass capacitance

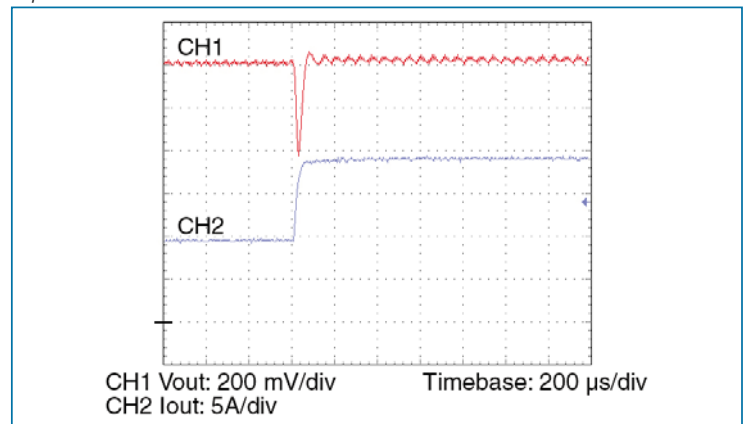

Figure 10-5 – Transient response 50 – 100%, 3 x 4.7 µF ceramic bypass capacitance

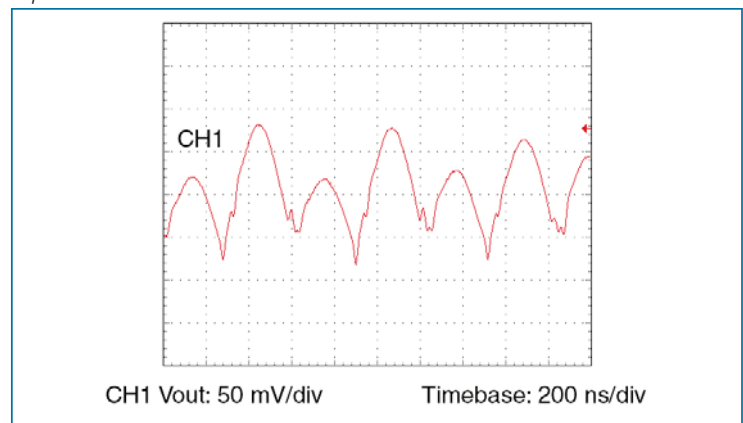

Figure 10-6 – Output voltage ripple at nominal line and full load with no external bypass capacitance.

15 Vout, 200 W OPERATING SPECIFICATIONS - (e.g. DC048B150T020FP)

Parameter	Min	Typ	Max	Unit	Notes
Efficiency	89	92		%	Nominal input; full load; 25°C
Ripple and noise		115	144	mV	p-p; Nominal input; full load; 20 MHz bandwidth
Output OVP setpoint	18.67		19.8	Volts	25°C; recycle input voltage to restart (1 minute off)
Dissipation, standby		5.5	7.6	Watts	No load
Load regulation		±0.6	±1.5	%	No load to full load; nominal input, deviation from setpoint
Output capacitance			423	µF	External
Load current	0		13.33	Amps	
Current limit (peak)	14.40	15.33	17.33	Amps	Shut down, may require PC enable to initiate restart
Short circuit current (avg)	0	1.0	6.67	Amps	Shut down, may require PC enable to initiate restart

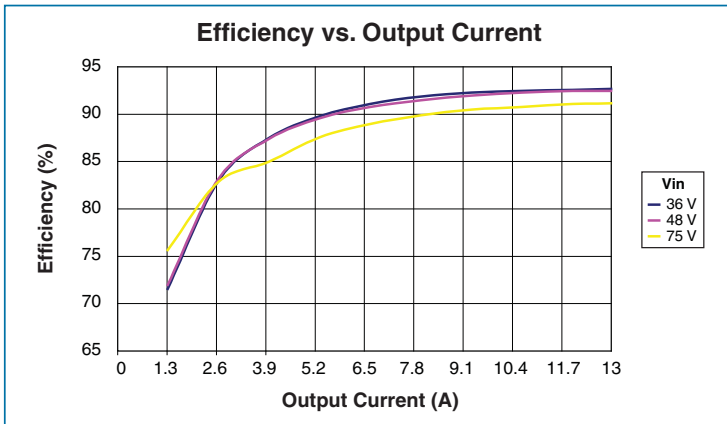

Figure 11-1 – Efficiency vs. load

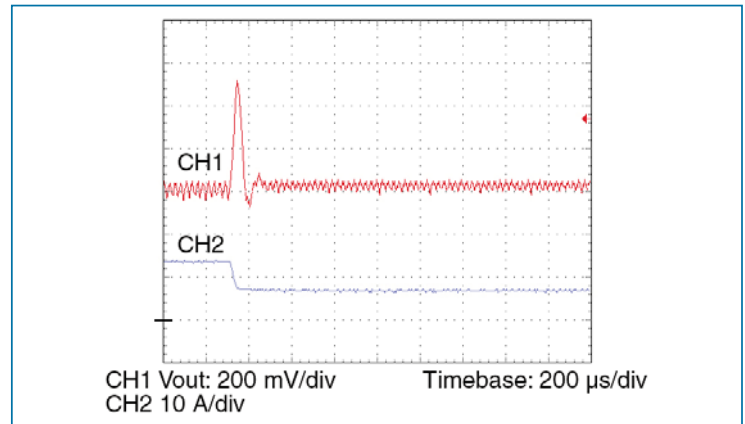

Figure 11-4 – Transient response 100 – 50%, 3 x 4.7 µF ceramic bypass capacitance

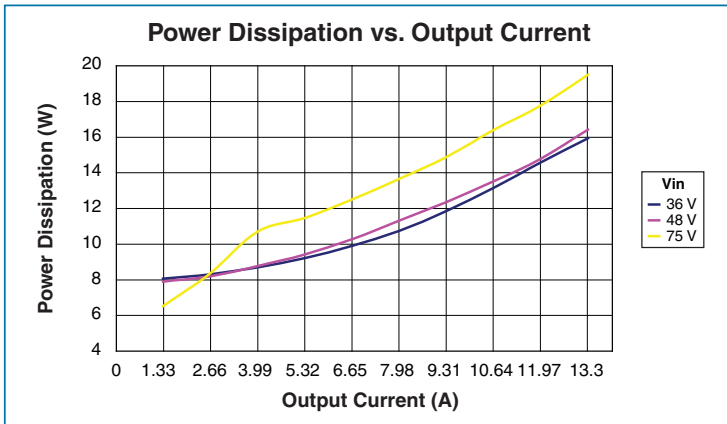

Figure 11-2 – Power dissipation vs. load

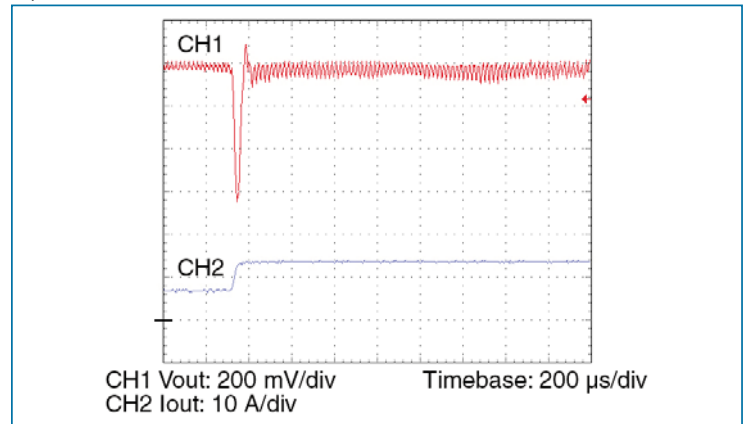

Figure 11-5 – Transient response 50 – 100%, 3 x 4.7 µF ceramic bypass capacitance

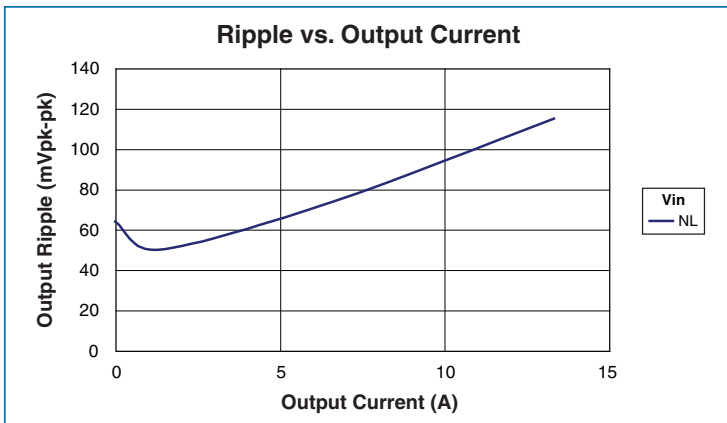

Figure 11-3 – Output ripple vs. load with no external bypass capacitance

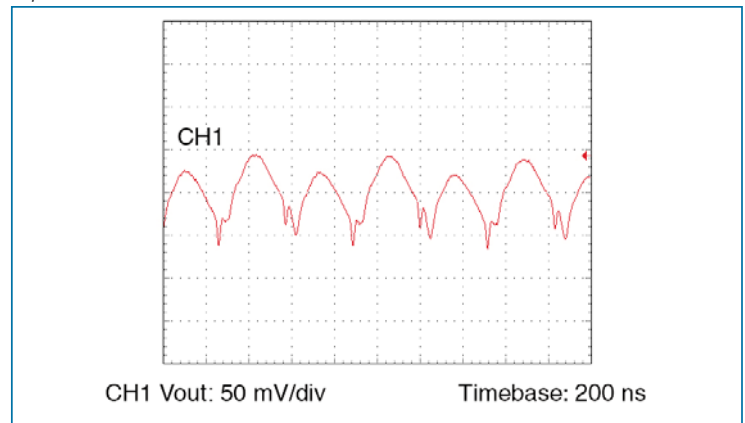

Figure 11-6 – Output voltage ripple at nominal line and full load with no external bypass capacitance.

24 Vout, 220 W OPERATING SPECIFICATIONS - (e.g. DC048B240T022FP)

Parameter	Min	Typ	Max	Unit	Notes
Efficiency	87	92		%	Nominal input; full load; 25°C
Ripple and noise		108	135	mV	p-p; Nominal input; full load; 20 MHz bandwidth
Output OVP setpoint	28.0		29.7	Volts	25°C; recycle input voltage to restart (1 minute off)
Dissipation, standby		5.5	7.6	Watts	No load
Load regulation		±0.6	±1.5	%	No load to full load; nominal input, deviation from setpoint
Output capacitance			188	µF	External
Load current	0		9.17	Amps	
Current limit (peak)	9.90	10.55	11.92	Amps	Shut down, may require PC enable to initiate restart
Short circuit current (avg)	0	1.0	4.59	Amps	Shut down, may require PC enable to initiate restart

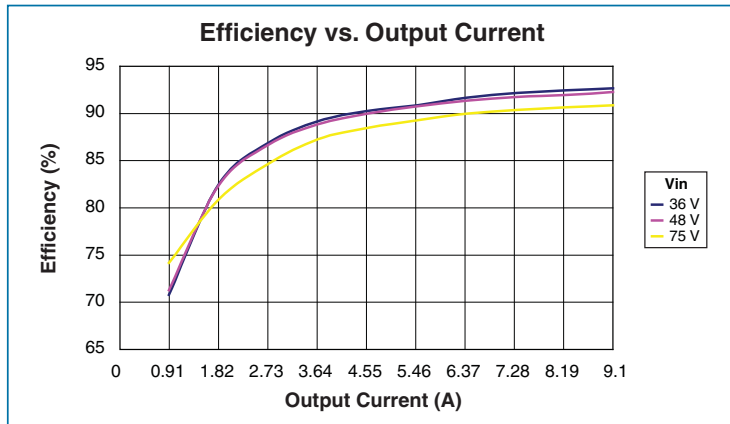

Figure 12-1 – Efficiency vs. load

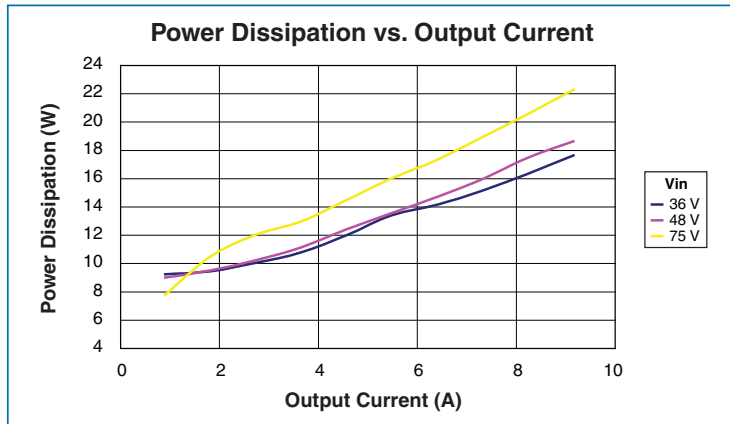

Figure 12-2 – Power dissipation vs. load

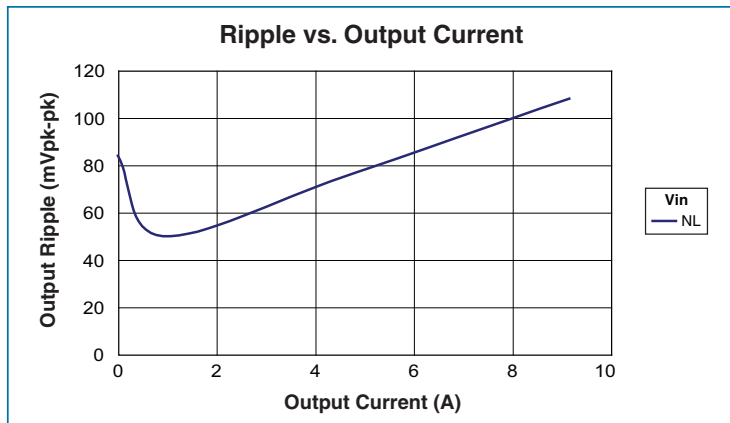

Figure 12-3 – Output ripple vs. load with no external bypass capacitance

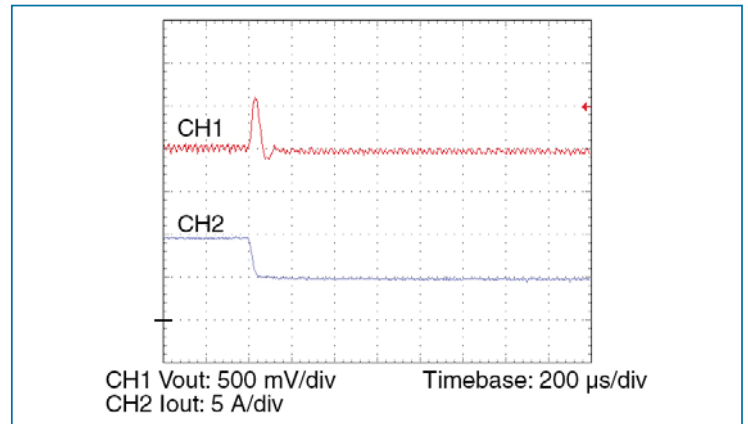

Figure 12-4 – Transient response 100 – 50%, 3 x 4.7 µF ceramic bypass capacitance

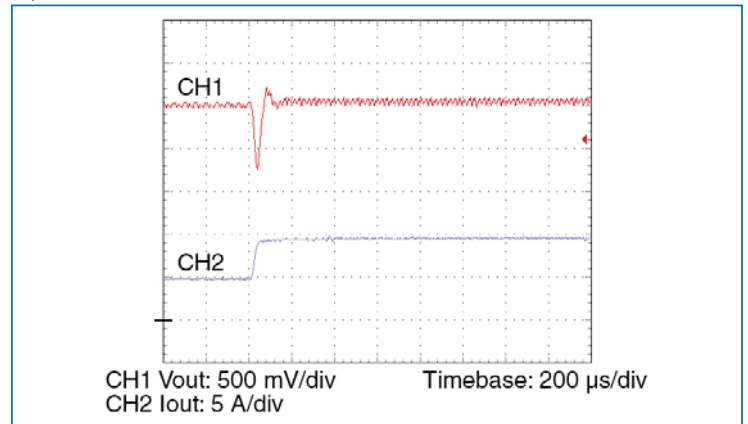

Figure 12-5 – Transient response 50 – 100%, 3 x 4.7 µF ceramic bypass capacitance

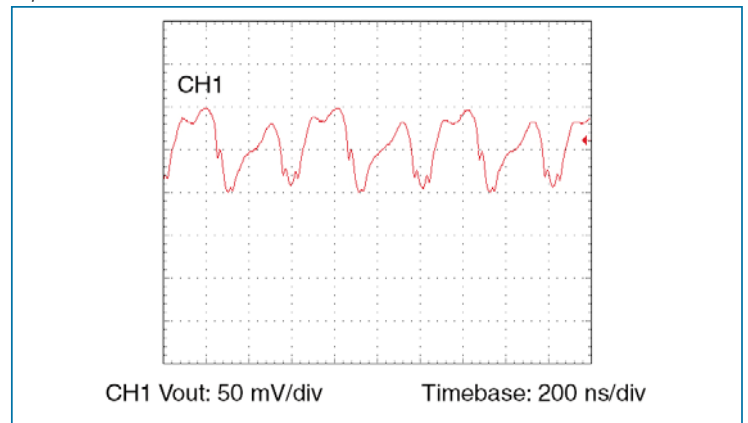

Figure 12-6 – Output voltage ripple at nominal line and full load with no external bypass capacitance.

28 Vout, 190 W OPERATING SPECIFICATIONS - (e.g. DC048B280T019FP)

Parameter	Min	Typ	Max	Unit	Notes
Efficiency	89	92		%	Nominal input; full load; 25°C
Ripple and noise		130	163	mV	p-p; Nominal input; full load; 20 MHz bandwidth
Output OVP setpoint	37.33		39.6	Volts	25°C; recycle input voltage to restart (1 minute off)
Dissipation, standby		5.5	7.6	Watts	No load
Load regulation		±0.6	±1.5	%	No load to full load; nominal input, deviation from setpoint
Output capacitance			106	µF	External
Load current	0		6.79	Amps	
Current limit (peak)	7.33	7.81	8.83	Amps	Shut down, may require PC enable to initiate restart
Short circuit current (avg)	0	10	3.40	Amps	Shut down, may require PC enable to initiate restart

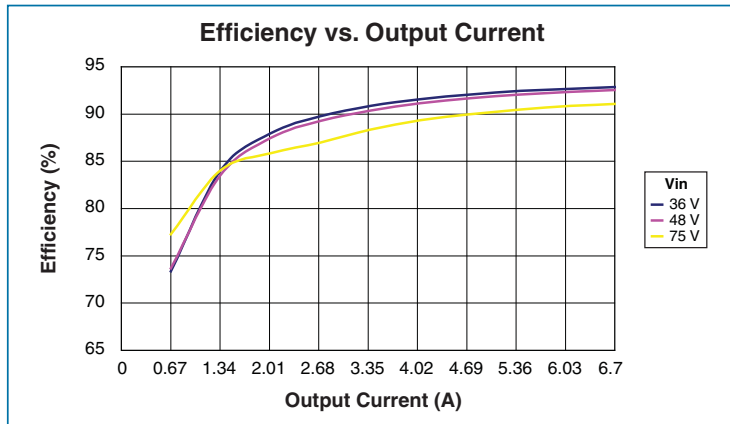

Figure 13-1 – Efficiency vs. load

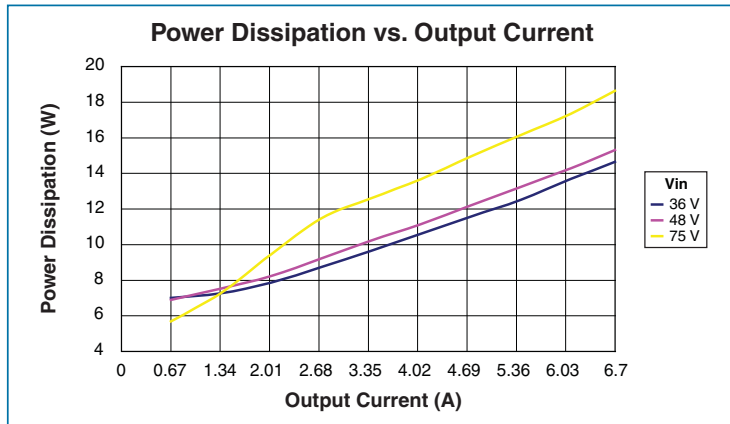

Figure 13-2 – Power dissipation vs. load

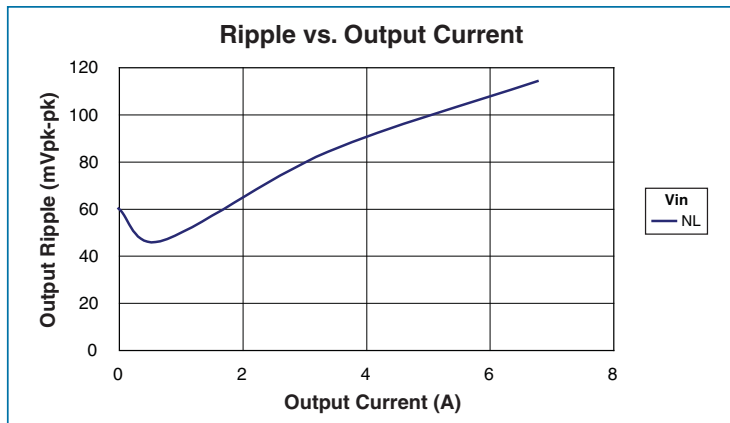

Figure 13-3 – Output ripple vs. load with no external bypass capacitance

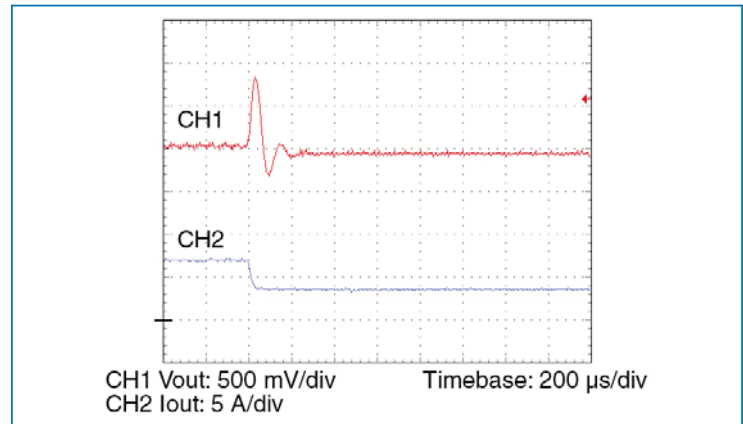

Figure 13-4 – Transient response 100 – 50%, 3 x 4.7 µF ceramic bypass capacitance

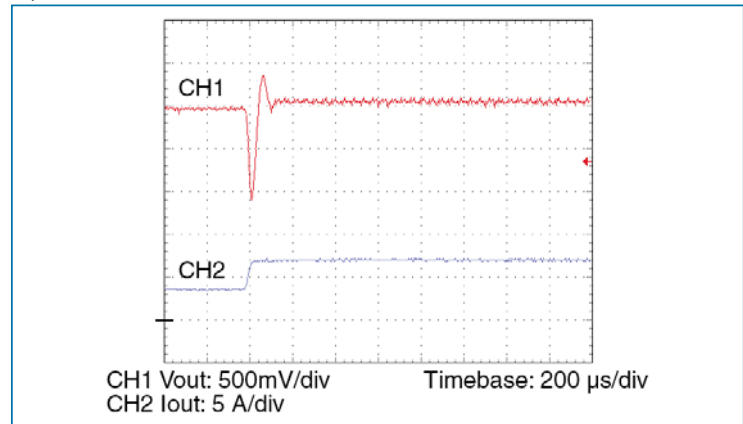

Figure 13-5 – Transient response 50 – 100%, 3 x 4.7 µF ceramic bypass capacitance

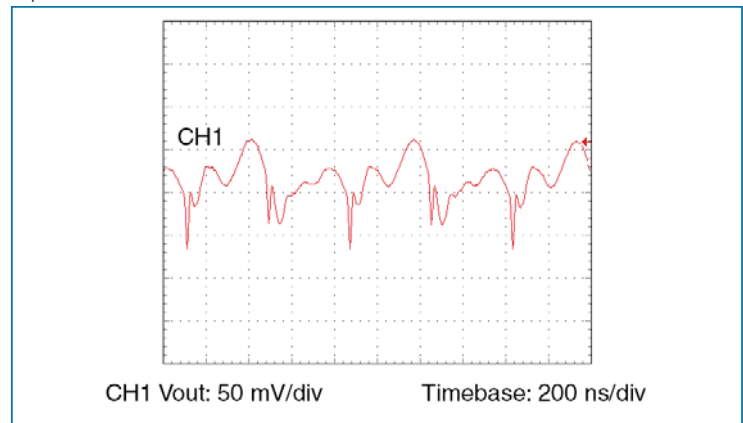

Figure 13-6 – Output voltage ripple at nominal line and full load with no external bypass capacitance.

48 Vout, 220 W OPERATING SPECIFICATIONS - (e.g. DC048B480T022FP)

Parameter	Min	Typ	Max	Unit	Notes
Efficiency	90	93		%	Nominal input; full load; 25°C
Ripple and noise		160	200	mV	p-p; Nominal input; full load; 20 MHz bandwidth
Output OVP setpoint	56.0		59.4	Volts	25°C; recycle input voltage to restart (1 minute off)
Dissipation, standby		5.5	7.6	Watts	No load
Load regulation		±0.6	±1.5	%	No load to full load; nominal input, deviation from setpoint
Output capacitance			47	µF	External
Load current	0		4.58	Amps	
Current limit (peak)	4.95	5.27	5.95	Amps	Shut down, may require PC enable to initiate restart
Short circuit current (avg)	0	1.0	2.29	Amps	Shut down, may require PC enable to initiate restart

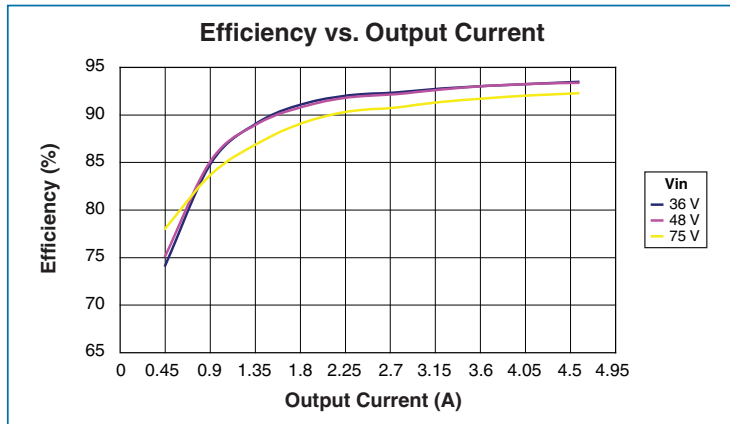

Figure 14-1 – Efficiency vs. load

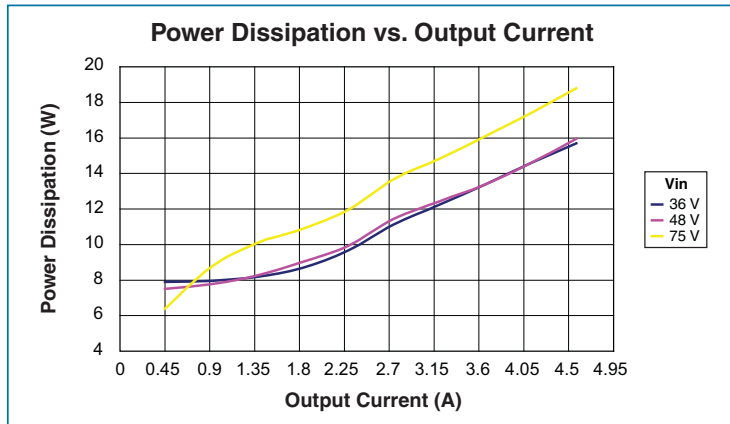

Figure 14-2 – Power dissipation vs. load

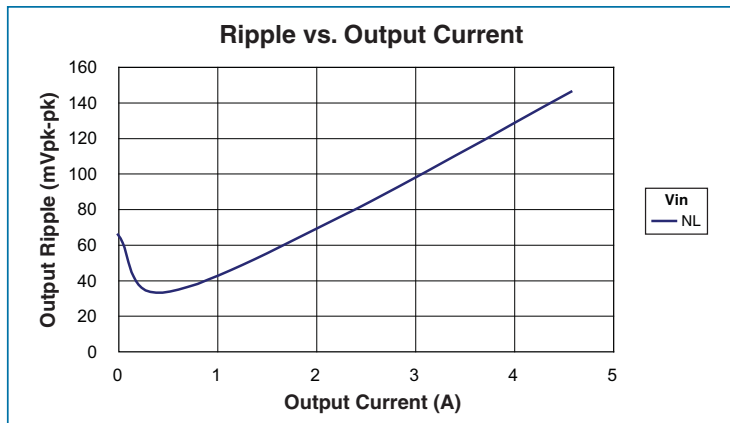

Figure 14-3 – Output ripple vs. load with no external bypass capacitance

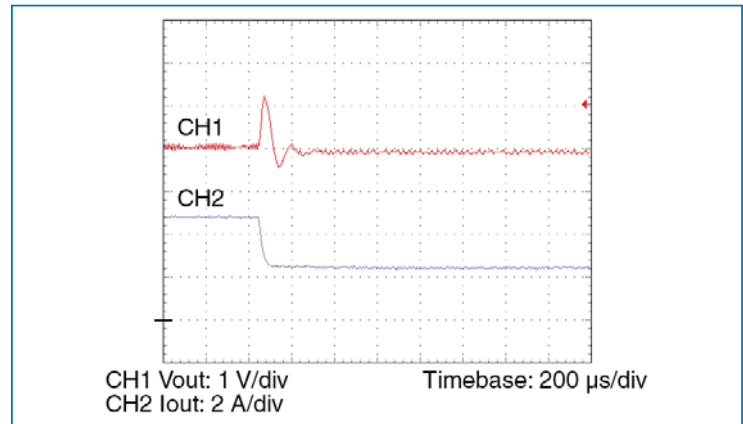

Figure 14-4 – Transient response 100 – 50%, 3 x 4.7 µF ceramic bypass capacitance

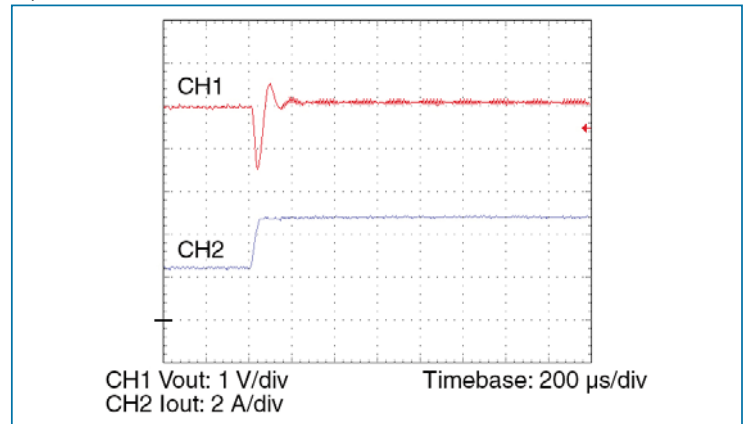

Figure 14-5 – Transient response 50 – 100%, 3 x 4.7 µF ceramic bypass capacitance

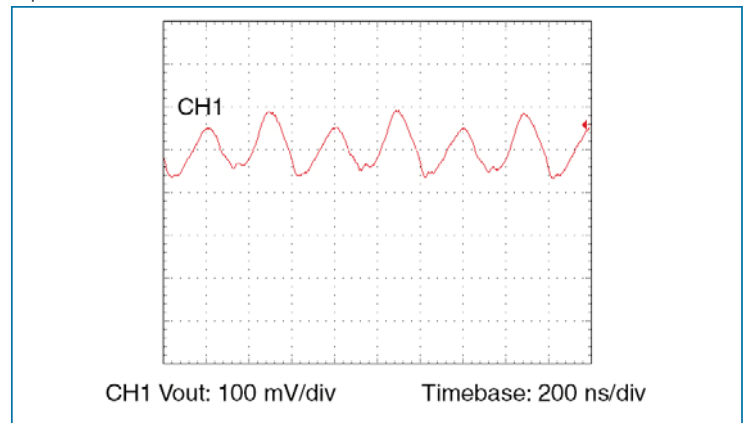

Figure 14-6 – Output voltage ripple at nominal line and full load with no external bypass capacitance.

PIN / CONTROL FUNCTIONS

+In / -In DC Voltage Ports

The maximum input voltage should not be exceeded. The modules have internal over / undervoltage lockout functions that prevent operation outside of the specified input range. They will turn on when the input voltage rises above its undervoltage lockout. If the input voltage exceeds the overvoltage lockout, the module will shut down until the overvoltage fault clears. PC will toggle indicating an out of bounds condition.

PC – Primary Control

The output voltage is enabled when the PC pin is open circuit (floating). To disable the module's output voltage, the PC pin is pulled low (referenced to -IN). Open collector optocouplers, transistors, or relays can be used to control the PC pin. During an abnormal condition the PC pin will pulse (Figure 17) as the module initiates a restart cycle. This will continue until the abnormal condition is rectified. The PC pin should not be used as an auxiliary voltage supply, nor should it be switched at a rate greater than 1 Hz.

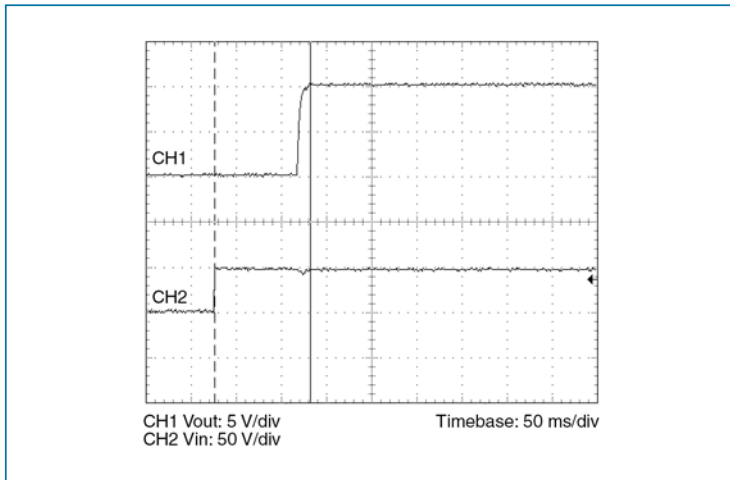

Figure 15 — Nominal line full load, turn on delay, Vin vs. Vout

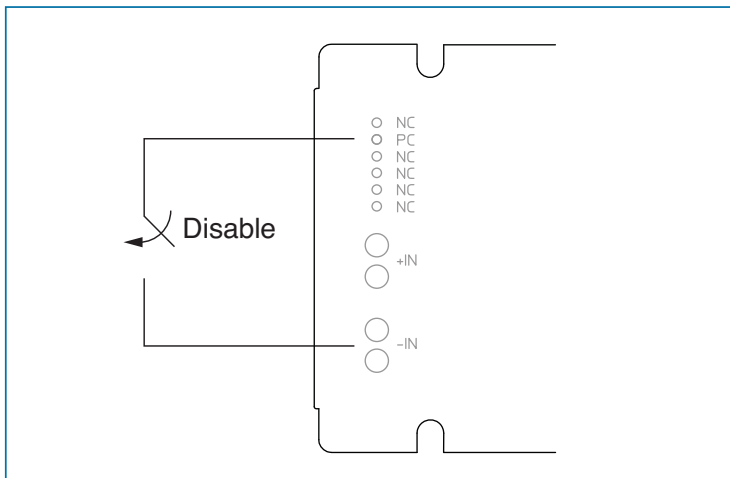

Figure 16 — Module enable/disable.

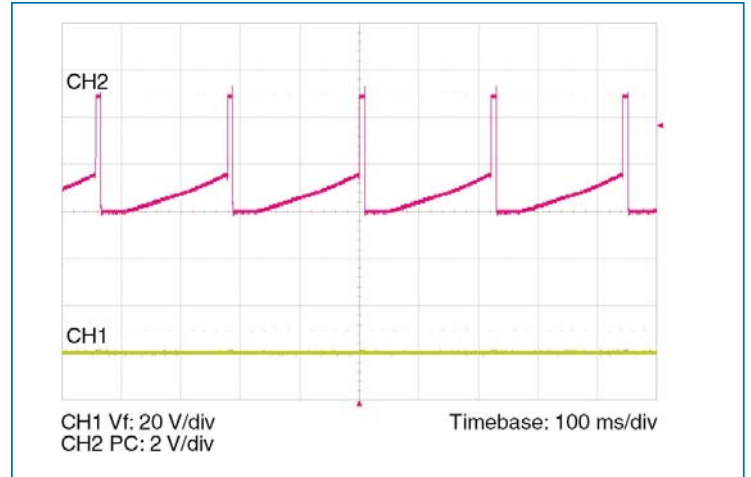

Figure 17 — PC module alarm logic

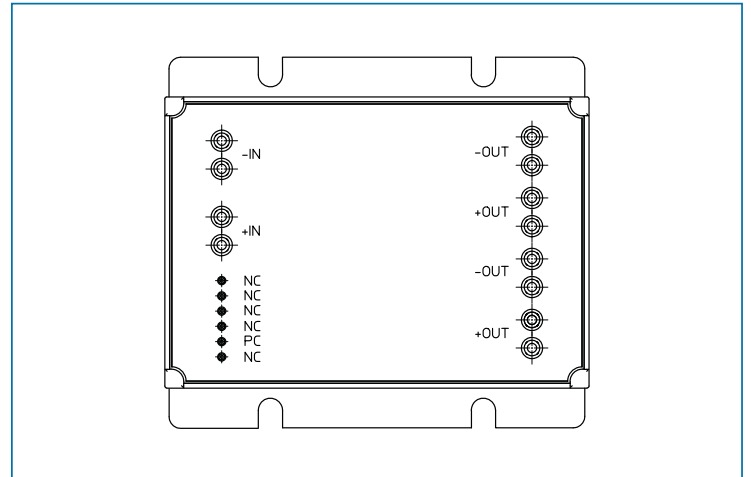

Figure 18 — Pin configuration (as viewed from pin side)

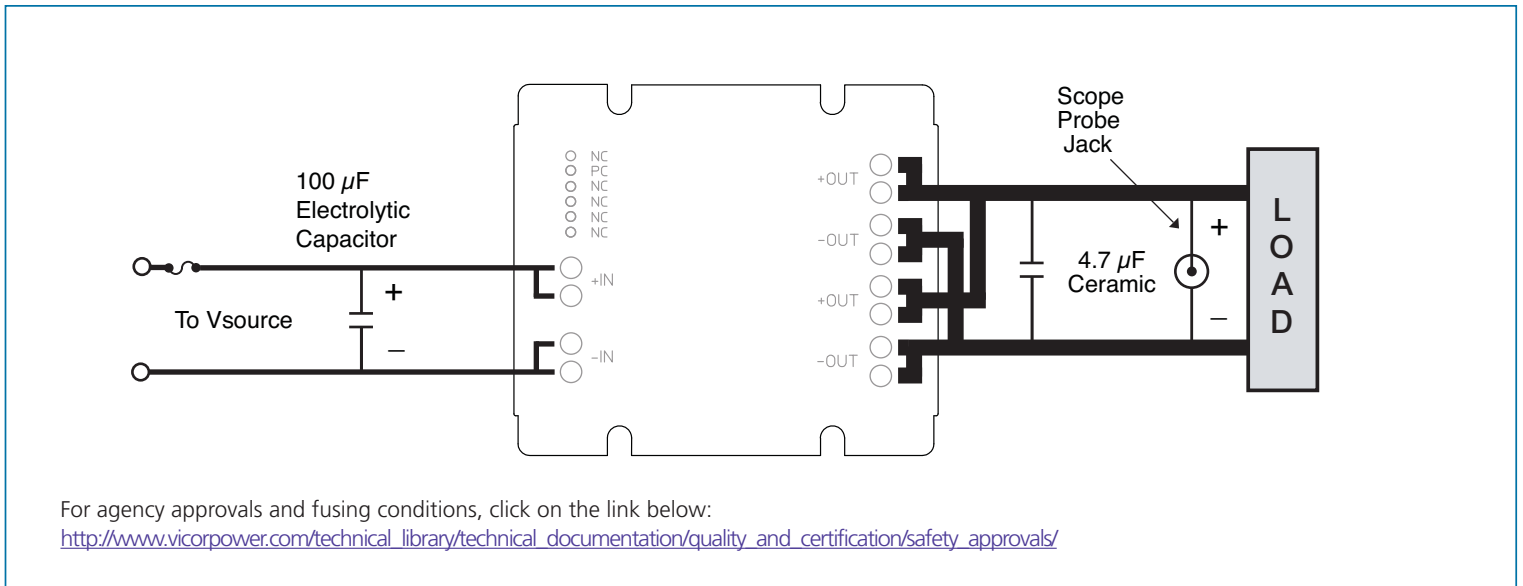

Figure 19 — Test set-up diagram for input and output ripple.

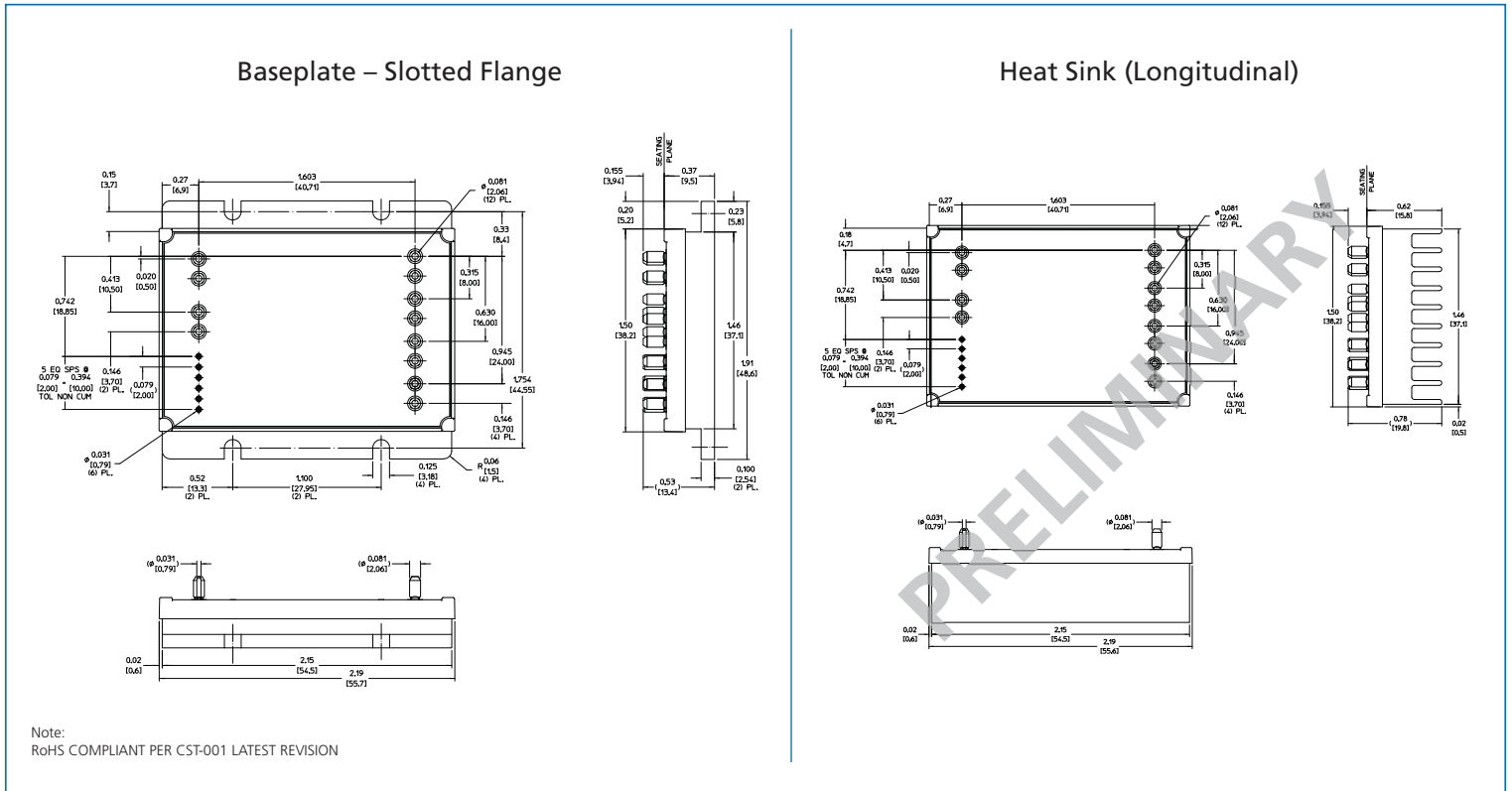

Figure 20 — Module outline

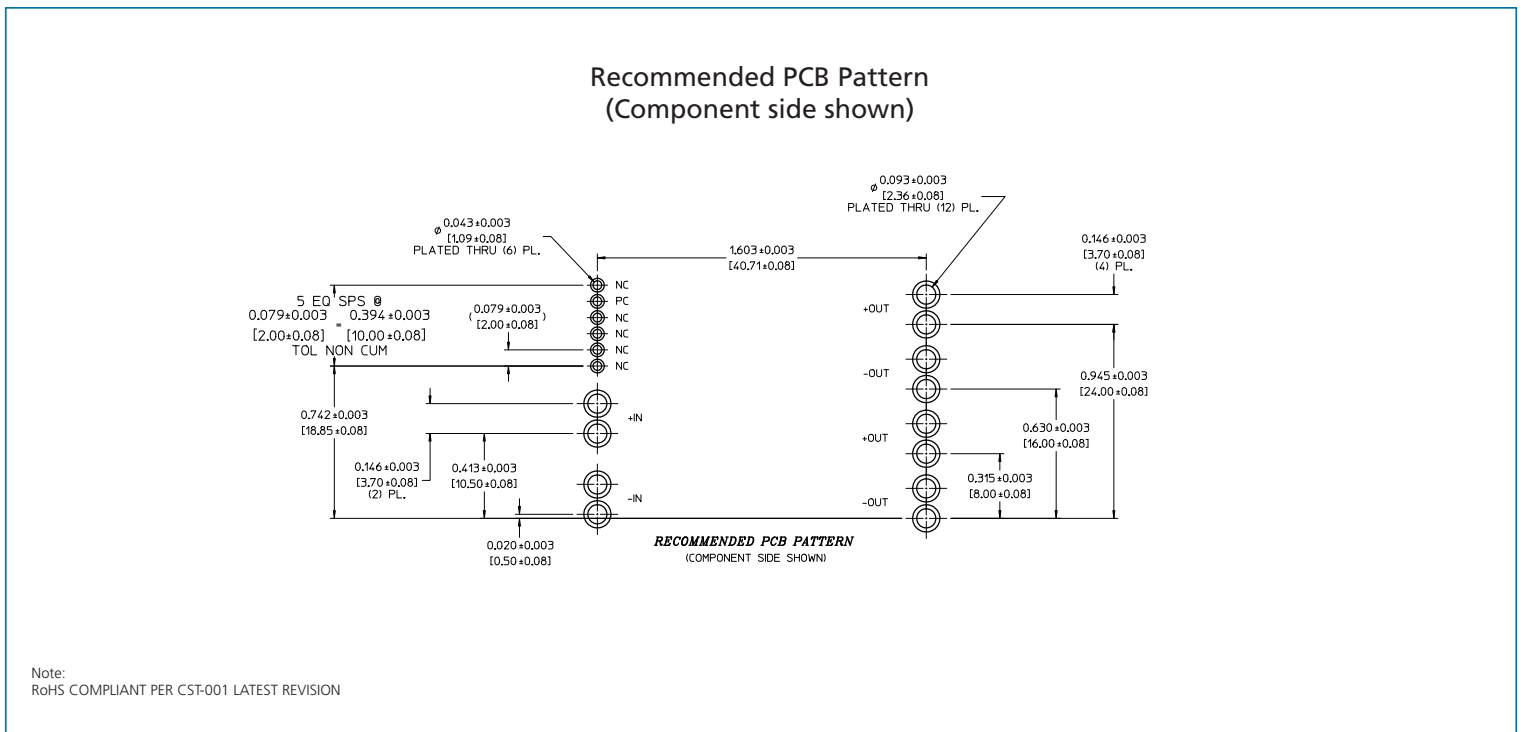

Figure 21 — PCB mounting specifications

Warranty

Vicor products are guaranteed for two years from date of shipment against defects in material or workmanship when in normal use and service. This warranty does not extend to products subjected to misuse, accident, or improper application or maintenance. Vicor shall not be liable for collateral or consequential damage. This warranty is extended to the original purchaser only.

EXCEPT FOR THE FOREGOING EXPRESS WARRANTY, VICOR MAKES NO WARRANTY, EXPRESS OR IMPLIED, INCLUDING, BUT NOT LIMITED TO, THE WARRANTY OF MERCHANTABILITY OR FITNESS FOR A PARTICULAR PURPOSE.

Vicor will repair or replace defective products in accordance with its own best judgement. For service under this warranty, the buyer must contact Vicor to obtain a Return Material Authorization (RMA) number and shipping instructions. Products returned without prior authorization will be returned to the buyer. The buyer will pay all charges incurred in returning the product to the factory. Vicor will pay all reshipment charges if the product was defective within the terms of this warranty.

Information published by Vicor has been carefully checked and is believed to be accurate; however, no responsibility is assumed for inaccuracies. Vicor reserves the right to make changes to any products without further notice to improve reliability, function, or design. Vicor does not assume any liability arising out of the application or use of any product or circuit; neither does it convey any license under its patent rights nor the rights of others. Vicor general policy does not recommend the use of its components in life support applications wherein a failure or malfunction may directly threaten life or injury. Per Vicor Terms and Conditions of Sale, the user of Vicor components in life support applications assumes all risks of such use and indemnifies Vicor against all damages.

Vicor's comprehensive line of power solutions includes high density AC-DC and DC-DC modules and accessory components, fully configurable AC-DC and DC-DC power supplies, and complete custom power systems.

Information furnished by Vicor is believed to be accurate and reliable. However, no responsibility is assumed by Vicor for its use. Vicor components are not designed to be used in applications, such as life support systems, wherein a failure or malfunction could result in injury or death. All sales are subject to Vicor's Terms and Conditions of Sale, which are available upon request.

Specifications are subject to change without notice.

Intellectual Property Notice

Vicor and its subsidiaries own Intellectual Property (including issued U.S. and Foreign Patents and pending patent applications) relating to the products described in this data sheet. Interested parties should contact Vicor's Intellectual Property Department.

The products described on this data sheet are protected by the following U.S. Patents Numbers: 5,945,130; 6,403,009; 6,710,257; 6,788,033; 6,940,013; 6,969,909; 7,038,917; 7,154,250; 7,166,898; 7,187,263; 7,202,646; D496,906; D506,438; D509,472; 6,911,848; 6,930,893; 6,934,166; 7,145,186; D505,114; and for use under 6,975,098 and 6,984,965

Vicor Corporation
25 Frontage Road
Andover, MA, USA 01810
Tel: 800-735-6200
Fax: 978-475-6715

email

Customer Service: custserv@vicorpower.com
Technical Support: apps@vicorpower.com