

AMMC-5026

2–35 GHz GaAs MMIC Traveling Wave Amplifier

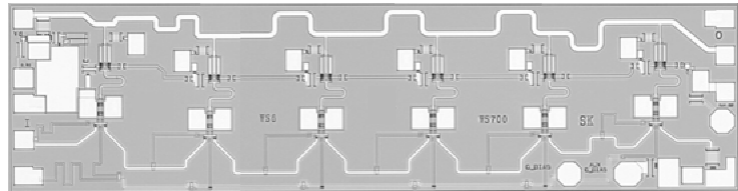

Data Sheet



Chip Size: 3050 x 840 μm (119 x 33 mils)
Chip Size Tolerance: $\pm 10 \mu\text{m}$ (± 0.4 mils)
Chip Thickness: $100 \pm 10 \mu\text{m}$ (4 ± 0.4 mils)
Pad Dimensions: $75 \times 75 \mu\text{m}$ (2.9 ± 0.4 mils)

Description

The AMMC-5026 is a broadband PHEMT GaAs MMIC Traveling Wave Amplifier (TWA) designed for medium output power and high gain over the full 2 GHz to 35 GHz frequency range. The design employs a 6-section cascode connected FET structure to provide flat gain and medium power as well as uniform group delay. For improved reliability and moisture protection, the die is passivated at the active areas.

Applications

- Broadband gain block
- Broadband driver amplifier
- 10 Gb/s Fiber Optics

Features

- Frequency range: 2–35 GHz
- Gain: 10.5 dB
- Gain flatness: ± 0.8 dB
- Return loss:
Input 17 dB, Output: 15 dB
- Output power (P-1dB):
24 dBm at 10 GHz
23 dBm at 20 GHz
22 dBm at 26 GHz
- Noise figure (6–19 GHz): ≤ 4 dB

Absolute Maximum Ratings^[1]

Symbol	Parameters/Conditions	Units	Min.	Max.
V_{dd}	Positive Drain Voltage	V		10
I_{dd}	Total Drain Current	mA		450
V_{g1}	First Gate Voltage	V	-5	
I_{g1}	First Gate Current	mA	-9	+5
V_{g2}	Second Gate Voltage	V	-3	+3.5
I_{g2}	Second Gate Current	mA	-10	
P_{in}	CW Input Power	dBm		23
T_{ch}	Channel Temperature	$^{\circ}\text{C}$		+150
T_b	Operating Backside Temperature	$^{\circ}\text{C}$	-55	
T_{stg}	Storage Temperature	$^{\circ}\text{C}$	-65	+165
T_{max}	Max. Assembly Temp (60 sec max)	$^{\circ}\text{C}$		+300

Notes:

1. Operation in excess of any one of these conditions may result in permanent damage to this device.

AMMC-5026 DC Specifications/Physical Properties^[1]

Symbol	Parameters and Test Conditions	Units	Min.	Typ.	Max.
I_{dss}	Saturated Drain Current ($V_{dd}=7V, V_{g1}=0V, V_{g2}=\text{open circuit}$)	mA	250	350	450
V_{p1}	First Gate Pinch-off Voltage ($V_{dd}=7V, I_{dd}=0.1 I_{dss}, V_{g2}=\text{open circuit}$)	V		-1.2	
V_{g2}	Second Gate Self-bias Voltage ($V_{dd}=7V, I_{dd}=150\text{ mA}, V_{g2}=\text{open circuit}$)	V		3.5	
I_{dsoff} (V_{g1})	First Gate Pinch-off Current ($V_{dd}=7V, V_{g1}=3.5V, V_{g2}=\text{open circuit}$)	mA		75	
θ_{ch-b}	Thermal Resistance ^[2] (Backside temperature, $T_b = 25^\circ\text{C}$)	$^\circ\text{C/W}$		28	

Notes:

1. Backside temperature $T_b = 25^\circ\text{C}$ unless otherwise noted.
2. Channel-to-backside Thermal Resistance (θ_{ch-b}) = 38°C/W at $T_{channel}(T_c) = 150^\circ\text{C}$ as measured using the liquid crystal method. Thermal Resistance at backside temperature (T_b) = 25°C calculated from measured data.

RF Specifications^[3,4]

($V_{dd} = 7V, I_{dd}(Q) = 150\text{ mA}, Z_{in} = Z_0 = 50\Omega$)

Symbol	Parameters and Test Conditions	Units	Min.	Typ.	Max.
$ S_{21} ^2$	Small-signal Gain	dB	8.5	10.5	12.5
$\Delta S_{21} ^2$	Small-signal Gain Flatness	dB		± 0.75	± 1.5
RL_{in}	Input Return Loss	dB	13	17	
RL_{out}	Output Return Loss	dB	12	15	
$ S_{12} ^2$	Isolation	dB	23	26	
P_{-1dB}	Output Power @ 1 dB Gain Compression	$f = 10\text{ GHz}$ dBm	22	24	
P_{sat}	Saturated Output Power	$f = 10\text{ GHz}$ dBm		26	
OIP3	Output 3 rd Order Intercept Point, $RF_{in1} = RF_{in2} = -20\text{ dBm}, f = 10\text{ GHz}, \Delta f = 2\text{ MHz}$	dBm		31	
NF	Noise Figure	$f = 10\text{ GHz}$ dB $f = 20\text{ GHz}$ dB		3.6 4.3	
H2	Second Harmonic ($P_{in} = 12\text{ dBm}$ at 10 GHz)	dBc		-20	-17.5
H3	Third Harmonic ($P_{in} = 12\text{ dBm}$ at 10 GHz)	dBc		-30	-28

Notes:

1. Data measured in wafer form, $T_{chuck} = 25^\circ\text{C}$.
2. 100% on wafer RF test is done at frequency = 2, 10, 22, 26.5, and 35 GHz, except as noted.

AMMC-5026 Typical Performance

($T_{\text{chuck}} = 25^{\circ}\text{C}$, $V_{\text{dd}} = 7\text{V}$, $I_{\text{dd}} = 150\text{ mA}$, $V_{\text{g2}} = \text{Open}$, $Z_0 = 50\Omega$)

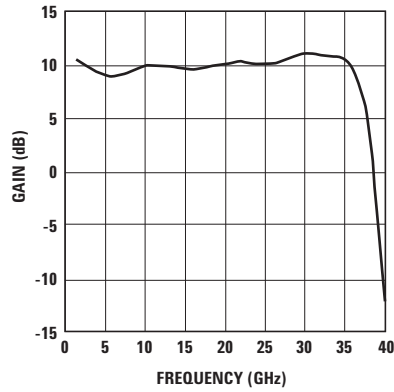

Figure 1. Gain.

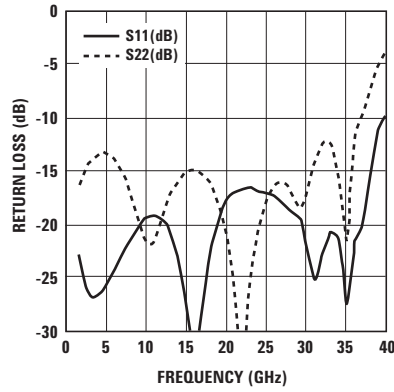

Figure 2. Input and Output Return Loss.

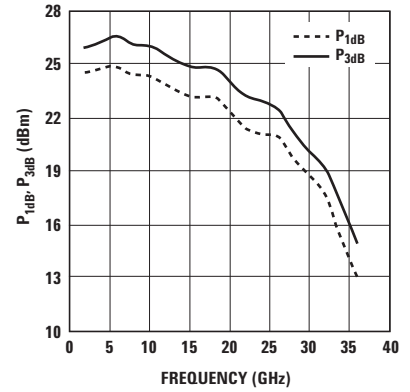

Figure 3. Output Power at $P_{1\text{dB}}$ and $P_{3\text{dB}}$.

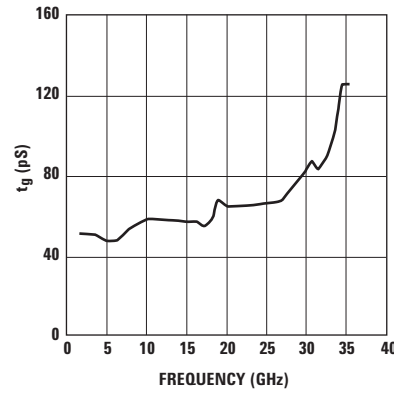

Figure 4. Group Delay.

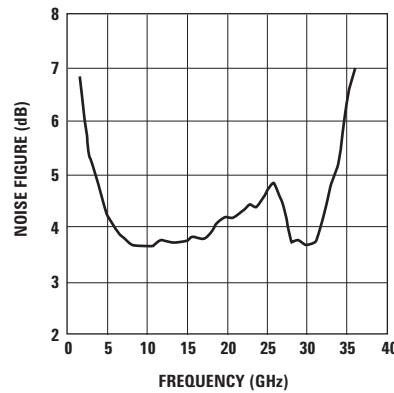

Figure 5. Noise Figure.

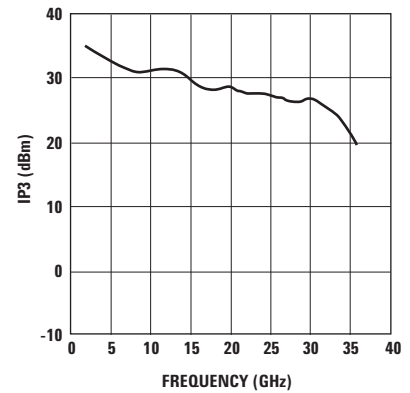

Figure 6. Output 3rd Order Intercept Point.

AMMC-5026 Typical Performance

($T_{\text{chuck}} = 25^{\circ}\text{C}$, $V_{\text{dd}} = 8\text{V}$, $I_{\text{dd}} = 150\text{mA}$, $V_{\text{g2}} = \text{Open}$, $Z_0 = 50\Omega$)

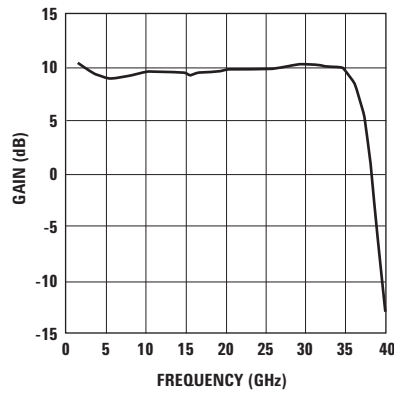

Figure 7. Gain.

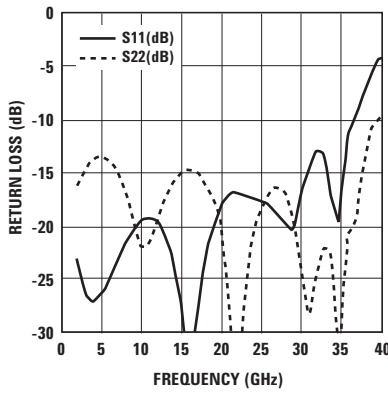

Figure 8. Input and Output Return Loss.

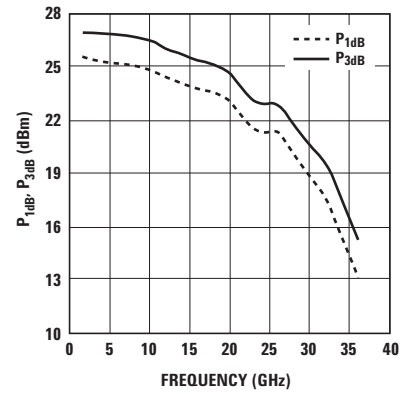

Figure 9. Output Power at $P_{1\text{dB}}$ and $P_{3\text{dB}}$.

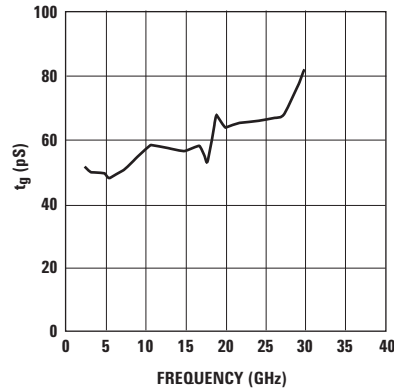

Figure 10. Group Delay.

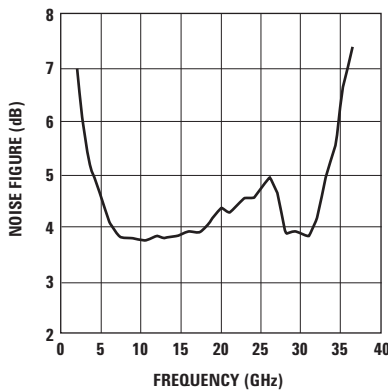

Figure 11. Noise Figure.

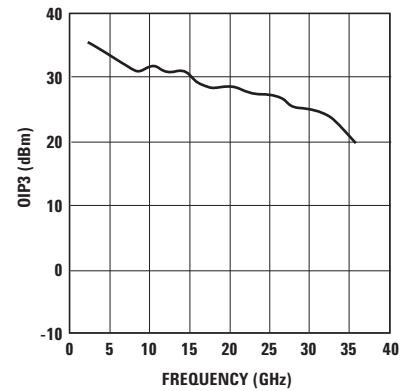

Figure 12. Output 3rd Order Intercept Point.

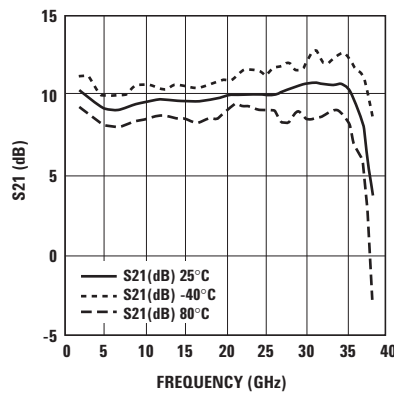

Figure 13. Gain vs. Temperature.

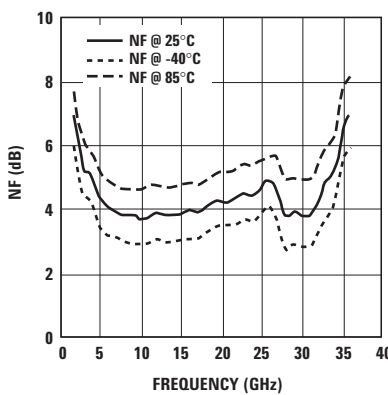

Figure 14. Noise Figure vs. Temperature.

AMMC-5026 Typical Scattering Parameters^[1]

($T_{\text{chuck}} = 25^{\circ}\text{C}$, $V_{\text{dd}} = 7\text{V}$, $I_{\text{dd}} = 150\text{ mA}$)

Freq. GHz	S_{11}			S_{21}			S_{12}			S_{22}		
	dB	Mag	Ang	dB	Mag	Ang	dB	Mag	Ang	dB	Mag	Ang
2.0	-24.93	0.06	-56	9.89	3.12	130	-52.04	0.0025	-109	-17.16	0.14	-126
3.0	-26.84	0.05	-18	9.50	2.98	112	-48.40	0.0038	-131	-15.78	0.16	-154
4.0	-25.16	0.06	-2	9.14	2.87	94	-45.19	0.0055	-154	-14.87	0.18	179
5.0	-23.72	0.07	2	8.90	2.79	77	-43.10	0.0070	-174	-14.55	0.19	154
6.0	-22.99	0.07	2	8.81	2.76	60	-41.31	0.0086	164	-14.82	0.18	128
7.0	-22.58	0.07	1	8.87	2.78	42	-40.00	0.0100	143	-15.68	0.16	101
8.0	-21.97	0.08	1	9.04	2.83	24	-38.94	0.0113	122	-17.22	0.14	73
9.0	-21.29	0.09	-3	9.24	2.90	5	-38.13	0.0124	103	-19.41	0.11	39
10.0	-20.67	0.09	-7	9.42	2.96	-15	-37.33	0.0136	84	-21.84	0.08	-6
11.0	-20.29	0.10	-16	9.53	2.99	-35	-36.65	0.0147	66	-22.43	0.08	-62
12.0	-20.47	0.09	-29	9.56	3.01	-56	-36.03	0.0158	49	-20.48	0.09	-110
13.0	-21.49	0.08	-43	9.52	2.99	-76	-35.34	0.0171	32	-18.32	0.12	-145
14.0	-23.65	0.07	-59	9.46	2.97	-97	-34.61	0.0186	14	-16.78	0.14	-172
15.0	-28.02	0.04	-81	9.40	2.95	-117	-33.89	0.0202	-3	-15.83	0.16	165
16.0	-39.49	0.01	-131	9.36	2.94	-137	-32.96	0.0225	-22	-15.57	0.17	144
17.0	-31.18	0.03	86	9.41	2.95	-157	-32.22	0.0245	-41	-15.93	0.16	125
18.0	-24.21	0.06	60	9.52	2.99	-177	-31.57	0.0264	-62	-16.86	0.14	107
19.0	-20.93	0.09	38	9.68	3.05	162	-30.96	0.0283	-82	-18.63	0.12	91
20.0	-18.20	0.12	13	9.79	3.09	141	-30.60	0.0295	-104	-21.67	0.08	78
21.0	-17.48	0.13	-17	9.94	3.14	119	-30.17	0.0310	-125	-27.56	0.04	74
22.0	-17.43	0.13	-46	10.02	3.17	96	-29.90	0.0320	-147	-32.88	0.02	142
23.0	-17.77	0.13	-81	10.07	3.19	73	-29.74	0.0326	-168	-24.55	0.06	171
24.0	-18.27	0.12	-119	10.06	3.18	50	-29.50	0.0335	171	-19.79	0.10	163
25.0	-18.66	0.12	-161	10.04	3.18	27	-29.24	0.0345	150	-17.19	0.14	150
26.0	-18.56	0.12	156	10.08	3.19	4	-28.85	0.0361	129	-15.72	0.16	135
27.0	-18.60	0.12	112	10.20	3.24	-19	-28.34	0.0383	107	-15.10	0.18	119
28.0	-19.07	0.11	66	10.46	3.33	-44	-27.70	0.0412	83	-15.28	0.17	104
29.0	-19.79	0.10	9	10.75	3.45	-70	-27.23	0.0435	57	-16.61	0.15	89
30.0	-18.63	0.12	-59	10.99	3.54	-98	-26.80	0.0457	29	-19.73	0.10	80
31.0	-15.62	0.17	-116	11.07	3.58	-127	-26.67	0.0464	0	-24.26	0.06	102
32.0	-13.40	0.21	-161	10.93	3.52	-158	-26.82	0.0456	-29	-21.06	0.09	136
33.0	-12.69	0.23	161	10.79	3.46	171	-26.97	0.0448	-58	-17.40	0.13	133
34.0	-14.73	0.18	127	10.78	3.46	139	-26.96	0.0449	-89	-15.99	0.16	118
35.0	-26.00	0.05	120	10.83	3.48	102	-26.76	0.0459	-125	-17.25	0.14	107
36.0	-14.82	0.18	-157	10.24	3.25	58	-27.23	0.0435	-169	-18.78	0.12	120
37.0	-10.01	0.32	172	8.79	2.75	12	-28.38	0.0381	146	-16.58	0.15	125
38.0	-9.81	0.32	161	6.12	2.02	-42	-30.66	0.0293	91	-18.73	0.12	125
39.0	-6.40	0.48	157	-0.65	0.93	-90	-36.71	0.0146	44	-13.68	0.21	154
40.0	-4.23	0.61	135	-7.76	0.41	-109	-42.85	0.0072	18	-10.52	0.30	139

Note:

1. Data obtained from on-wafer measurements.

AMMC-5026 Typical Scattering Parameters^[1]

($T_{\text{chuck}} = 25^{\circ}\text{C}$, $V_{\text{dd}} = 8\text{V}$, $I_{\text{dd}} = 150\text{mA}$)

Freq. GHz	S_{11}			S_{21}			S_{12}			S_{22}		
	dB	Mag	Ang	dB	Mag	Ang	dB	Mag	Ang	dB	Mag	Ang
2.0	-24.88	0.06	-57	9.59	3.02	129	-51.70	0.0026	-109	-17.27	0.14	-123
3.0	-26.86	0.05	-19	9.20	2.88	112	-47.74	0.0041	-131	-15.97	0.16	-152
4.0	-25.30	0.05	-2	8.85	2.77	94	-45.04	0.0056	-153	-15.10	0.18	-179
5.0	-23.94	0.06	2	8.59	2.69	76	-42.85	0.0072	-175	-14.79	0.18	155
6.0	-23.17	0.07	2	8.49	2.66	59	-41.11	0.0088	164	-15.05	0.18	129
7.0	-22.72	0.07	1	8.54	2.67	41	-39.74	0.0103	144	-15.89	0.16	102
8.0	-22.09	0.08	1	8.70	2.72	23	-38.56	0.0118	123	-17.37	0.14	72
9.0	-21.42	0.08	-3	8.89	2.78	4	-37.72	0.0130	104	-19.46	0.11	38
10.0	-20.79	0.09	-7	9.07	2.84	-16	-37.02	0.0141	85	-21.68	0.08	-7
11.0	-20.42	0.10	-17	9.17	2.87	-37	-36.31	0.0153	67	-22.16	0.08	-61
12.0	-20.68	0.09	-30	9.20	2.88	-58	-35.60	0.0166	49	-20.38	0.10	-108
13.0	-21.76	0.08	-44	9.15	2.87	-78	-34.94	0.0179	32	-18.33	0.12	-143
14.0	-24.04	0.06	-61	9.08	2.84	-99	-34.20	0.0195	14	-16.84	0.14	-171
15.0	-28.68	0.04	-83	9.01	2.82	-119	-33.47	0.0212	-3	-15.91	0.16	166
16.0	-40.72	0.01	-151	8.97	2.81	-139	-32.62	0.0234	-21	-15.67	0.16	145
17.0	-30.52	0.03	86	9.00	2.82	-159	-31.87	0.0255	-41	-16.02	0.16	125
18.0	-24.07	0.06	58	9.11	2.85	-180	-31.28	0.0273	-61	-16.95	0.14	107
19.0	-21.00	0.09	36	9.26	2.90	159	-30.66	0.0293	-81	-18.70	0.12	91
20.0	-18.37	0.12	12	9.35	2.93	137	-30.26	0.0307	-103	-21.76	0.08	77
21.0	-17.78	0.13	-18	9.49	2.98	115	-29.87	0.0321	-124	-27.81	0.04	69
22.0	-17.89	0.13	-49	9.57	3.01	93	-29.53	0.0334	-146	-34.56	0.02	146
23.0	-18.34	0.12	-84	9.60	3.02	70	-29.42	0.0338	-168	-24.90	0.06	175
24.0	-18.89	0.11	-123	9.57	3.01	46	-29.17	0.0348	172	-19.97	0.10	165
25.0	-19.20	0.11	-166	9.53	3.00	23	-28.95	0.0357	151	-17.32	0.14	151
26.0	-19.05	0.11	151	9.55	3.00	0	-28.57	0.0373	130	-15.83	0.16	136
27.0	-19.12	0.11	108	9.65	3.04	-24	-28.09	0.0394	108	-15.23	0.17	120
28.0	-19.87	0.10	62	9.88	3.12	-49	-27.47	0.0423	84	-15.44	0.17	105
29.0	-20.78	0.09	3	10.14	3.21	-75	-27.05	0.0444	58	-16.82	0.14	90
30.0	-19.42	0.11	-67	10.33	3.29	-103	-26.69	0.0463	30	-20.01	0.10	81
31.0	-16.18	0.16	-123	10.37	3.30	-133	-26.60	0.0468	1	-24.45	0.06	103
32.0	-13.92	0.20	-166	10.21	3.24	-164	-26.76	0.0459	-28	-21.24	0.09	136
33.0	-13.31	0.22	158	10.03	3.17	165	-26.92	0.0451	-57	-17.71	0.13	133
34.0	-15.52	0.17	129	9.95	3.14	132	-26.97	0.0448	-88	-16.44	0.15	119
35.0	-23.72	0.07	144	9.82	3.10	95	-27.01	0.0446	-124	-17.71	0.13	111
36.0	-14.68	0.18	-169	9.06	2.84	52	-27.64	0.0415	-167	-18.68	0.12	123
37.0	-10.47	0.30	166	7.43	2.35	6	-29.02	0.0354	148	-16.97	0.14	127
38.0	-9.72	0.33	159	4.27	1.64	-46	-31.77	0.0258	96	-18.00	0.13	136
39.0	-6.77	0.46	152	-2.02	0.79	-88	-37.46	0.0134	53	-13.26	0.22	151
40.0	-4.70	0.58	133	-8.14	0.39	-108	-42.97	0.0071	28	-10.51	0.30	138

Note:

1. Data obtained from on-wafer measurements.

Biasing and Operation

AMMC-5026 is biased with a single positive drain supply (V_d) and a negative gate supply (V_{g1}). The recommended bias conditions for the AMMC-5026 is $V_{dd} = 7V$ and $I_{dd} = 150\text{ mA}$ for best overall performance. Open circuit is the default setting for the V_{g2} biasing.

Figure 17 shows a typical bonding configuration for the 2 to 35 GHz operations. In this case, auxiliary drain and V_{g1} capacitors ($>0.5\ \mu\text{F}$) are used for low frequency (below 2 GHz) performance. Input and output RF ports are DC coupled; therefore, DC decoupling capacitors are required if there are DC paths.

The auxiliary gate and drain contacts are used for low frequency performance extension below 1 GHz. When used, these contacts must be AC coupled only. (Do not attempt to apply bias to these pads.)

Ground connections are made with plated through-holes to the backside of the device.

Assembly Techniques

The backside of the MMIC chip is RF ground. For microstrip applications the chip should be attached directly to the ground plane (e.g. circuit carrier or heatsink) using electrically conductive epoxy^[1,2]. For conductive epoxy, the amount should be just enough to provide a thin fillet around the bottom perimeter of the die. The ground plane should be free of any residue that may jeopardize electrical or mechanical attachment. Caution should be taken to not exceed the Absolute Maximum Rating for assembly temperature and time.

Thermosonic wedge bonding is the preferred method for wire attachment to the bond pads. The RF connections should be kept as short as possible to minimize inductance. Gold mesh or double-bonding with 0.7 mil gold wire is recommended.

Mesh can be attached using a 2 mil round tracking tool and a tool force of approximately 22 grams with an ultrasonic power of roughly 55 dB for a duration of $76 \pm 8\text{ mS}$. A guided wedge at an ultrasonic power level of 64 dB can be used for the 0.7 mil wire. The recommended wire bond stage temperature is $150 \pm 2^\circ\text{C}$.

The chip is 100 mm thick and should be handled with care.

This MMIC has exposed air bridges on the top surface. Handle at edges or with a custom collet (do not pick up die with vacuum on die center.)

This MMIC is also static sensitive and ESD handling precautions should be taken.

Notes:

1. Ablebond 84-1 LM1 silver epoxy is recommended.
2. Eutectic attach is not recommended and may jeopardize reliability of the device.

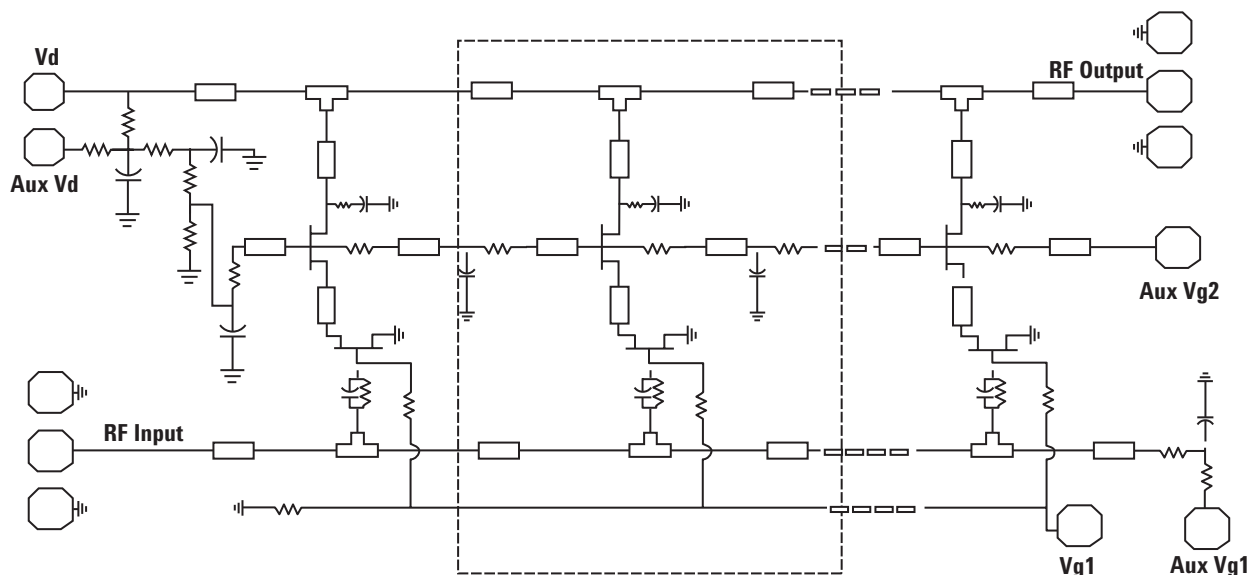

Figure 15. AMMC-5026 Schematic.

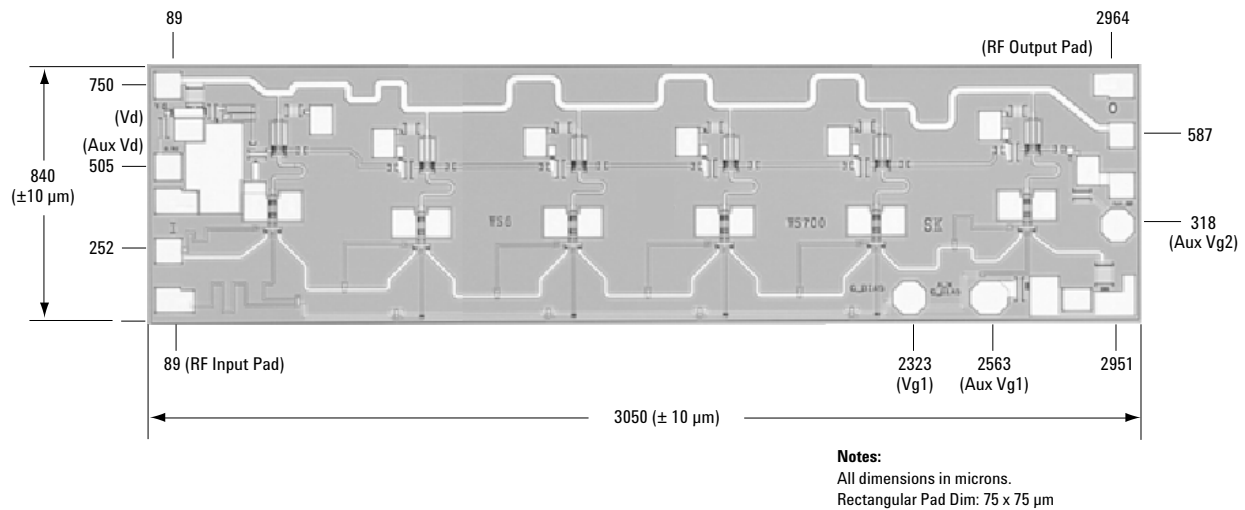

Figure 16. AMMC-5026 Bonding Pad Locations. (dimensions in micrometers)

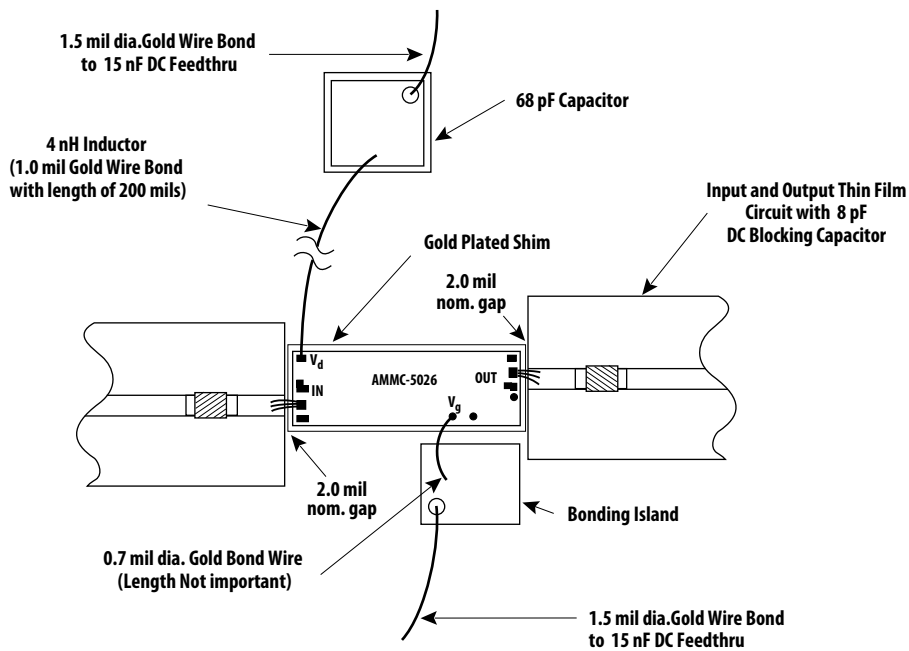

Figure 17. AMMC-5026 Assembly Diagram.

Ordering Information

AMMC-5026-W10 = 10 devices per tray

AMMC-5026-W50 = 50 devices per tray

For product information and a complete list of distributors, please go to our web site: www.avagotech.com

Avago, Avago Technologies, and the A logo are trademarks of Avago Technologies in the United States and other countries. Data subject to change. Copyright © 2005-2008 Avago Technologies. All rights reserved. Obsoletes 5989-3929EN AV02-1286EN - July 8, 2008

