

# LPV321 Single/ LPV358 Dual/ LPV324 Quad General Purpose, Low Voltage, Low Power, Rail-to-Rail Output Operational Amplifiers

## General Description

The LPV321/358/324 are low power (9µA per channel at 5.0V) versions of the LMV321/358/324 op amps. This is another addition to the LMV321/358/324 family of commodity op amps.

The LPV321/358/324 are the most cost effective solutions for the applications where low voltage, low power operation, space saving and low price are needed. The LPV321/358/324 have rail-to-rail output swing capability and the input common-mode voltage range includes ground. They all exhibit excellent speed-power ratio, achieving 152 KHz of bandwidth with a supply current of only 9µA.

The LPV321 is available in space saving SC70-5, which is approximately half the size of SOT23-5. The small package saves space on pc boards, and enables the design of small portable electronic devices. It also allows the designer to place the device closer to the signal source to reduce noise pickup and increase signal integrity.

The chips are built with National's advanced submicron silicon-gate BiCMOS process. The LPV321/358/324 have bipolar input and output stages for improved noise performance and higher output current drive.

## Features

(For  $V^+ = 5V$  and  $V^- = 0V$ , Typical Unless Otherwise Noted)

- Guaranteed 2.7V and 5V Performance
- No Crossover Distortion
- Space Saving Package
 

SC70-5
2.0x2.1x1.0mm
- Industrial Temp. Range
 

-40°C to +85°C
----------------
- Gain-Bandwidth Product
 

152KHz
--------
- Low Supply Current
 

LPV321	9µA
LPV358	15µA
LPV324	28µA
- Rail-to-Rail Output Swing
 

@ 100kΩ Load	$V^+ - 3.5mV$
	$V^- + 90mV$
- $V_{CM}$ 

-0.2V to $V^+ - 0.8V$
-----------------------

## Applications

- Active Filters
- General Purpose Low Voltage Applications
- General Purpose Portable Devices

**LPV321 Single/ LPV358 Dual/ LPV324 Quad General Purpose, Low Voltage, Low Power, Rail-to-Rail Output Operational Amplifiers**

## Connection Diagrams

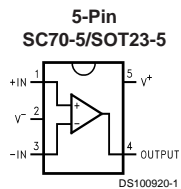

Top View

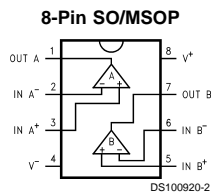

Top View

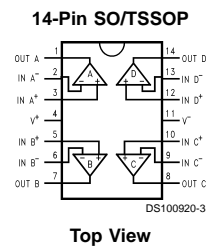

Top View

## Ordering Information

Package	Temperature Range	Packaging Marking	Transport Media	NSC Drawing
	Industrial -40°C to +85°C			
5-Pin SC70-5	LPV321M7	A19	1k Units Tape and Reel	MAA05
	LPV321M7X	A19	3k Units Tape and Reel	
5-Pin SOT23-5	LPV321M5	A27A	1k Units Tape and Reel	MA05B
	LPV321M5X	A27A	3k Units Tape and Reel	
8-Pin Small Outline	LPV358M	LPV358M	Rails	M08A
	LPV358MX	LPV358M	2.5k Units Tape and Reel	
8-Pin MSOP	LPV358MM	P358	1k Units Tape and Reel	MUA08A
	LPV358MMX	P358	3.5k Units Tape and Reel	
14-Pin Small Outline	LPV324M	LPV324M	Rails	M14A
	LPV324MX	LPV324M	2.5k Units Tape and Reel	
14-Pin TSSOP	LPV324MT	LPV324MT	Rails	MTC14
	LPV324MTX	LPV324MT	2.5k Units Tape and Reel	

## Absolute Maximum Ratings (Note 1)

If Military/Aerospace specified devices are required, please contact the National Semiconductor Sales Office/ Distributors for availability and specifications.

ESD Tolerance (Note 2)	
Machine Model	100V
Human Body Model	2000V
Differential Input Voltage	± Supply Voltage
Supply Voltage (V <sup>+</sup> -V <sup>-</sup> )	5.5V
Output Short Circuit to V <sup>+</sup>	(Note 3)
Output Short Circuit to V <sup>-</sup>	(Note 4)
Soldering Information	
Infrared or Convection (20 sec)	235°C
Storage Temp. Range	-65°C to 150°C

Junction Temp. (T<sub>J</sub>, max) (Note 5)

150°C

## Operating Ratings (Note 1)

Supply Voltage	2.7V to 5V
Temperature Range	-40°C ≤ T <sub>J</sub> ≤ 85°C
Thermal Resistance (θ <sub>JA</sub> )(Note 10)	
5-pin SC70-5	478°C/W
5-pin SOT23-5	265°C/W
8-Pin SOIC	190°C/W
8-Pin MSOP	235°C/W
14-Pin SOIC	145°C/W
14-Pin TSSOP	155°C/W

## 2.7V DC Electrical Characteristics

Unless otherwise specified, all limits guaranteed for T<sub>J</sub> = 25°C, V<sup>+</sup> = 2.7V, V<sup>-</sup> = 0V, V<sub>CM</sub> = 1.0V, V<sub>O</sub> = V<sup>+</sup>/2 and R<sub>L</sub> > 1 MΩ.

Symbol	Parameter	Conditions	Typ (Note 6)	Limit (Note 7)	Units
V <sub>OS</sub>	Input Offset Voltage		1.2	7	mV max
TCV <sub>OS</sub>	Input Offset Voltage Average Drift		2		µV/°C
I <sub>B</sub>	Input Bias Current		1.7	50	nA max
I <sub>OS</sub>	Input Offset Current		0.6	40	nA max
CMRR	Common Mode Rejection Ratio	0V ≤ V <sub>CM</sub> ≤ 1.7V	70	50	dB min
PSRR	Power Supply Rejection Ratio	2.7V ≤ V <sup>+</sup> ≤ 5V V <sub>O</sub> = 1V, V <sub>CM</sub> = 1V	65	50	dB min
V <sub>CM</sub>	Input Common-Mode Voltage Range	For CMRR ≥ 50dB	-0.2	0	V min
			1.9	1.7	V max
V <sub>O</sub>	Output Swing	R <sub>L</sub> = 100kΩ to 1.35V	V <sup>+</sup> -3	V <sup>+</sup> -100	mV min
			80	180	mV max
I <sub>S</sub>	Supply Current	LPV321	4	8	µA max
		LPV358 Both amplifiers	8	16	µA max
		LPV324 All four amplifiers	16	24	µA max

<b>2.7V AC Electrical Characteristics</b>					
Unless otherwise specified, all limits guaranteed for $T_J = 25^\circ\text{C}$ , $V^+ = 2.7\text{V}$ , $V^- = 0\text{V}$ , $V_{\text{CM}} = 1.0\text{V}$ , $V_O = V^+/2$ and $R_L > 1\text{M}\Omega$ .					
Symbol	Parameter	Conditions	Typ (Note 6)	Limit (Note 7)	Units
GBWP	Gain-Bandwidth Product	$C_L = 22\text{ pF}$	112		KHz
$\Phi_m$	Phase Margin		97		Deg
$G_m$	Gain Margin		35		dB
$e_n$	Input-Referred Voltage Noise	$f = 1\text{ kHz}$	178		$\frac{\text{nV}}{\sqrt{\text{Hz}}}$
$i_n$	Input-Referred Current Noise	$f = 1\text{ kHz}$	0.50		$\frac{\text{pA}}{\sqrt{\text{Hz}}}$
<b>5V DC Electrical Characteristics</b>					
Unless otherwise specified, all limits guaranteed for $T_J = 25^\circ\text{C}$ , $V^+ = 5\text{V}$ , $V^- = 0\text{V}$ , $V_{\text{CM}} = 2.0\text{V}$ , $V_O = V^+/2$ and $R_L > 1\text{M}\Omega$ . <b>Boldface</b> limits apply at the temperature extremes.					
Symbol	Parameter	Conditions	Typ (Note 6)	Limit (Note 7)	Units
$V_{\text{OS}}$	Input Offset Voltage		1.5	7 <b>10</b>	mV max
$\text{TCV}_{\text{OS}}$	Input Offset Voltage Average Drift		2		$\mu\text{V}/^\circ\text{C}$
$I_B$	Input Bias Current		2	50 <b>60</b>	nA max
$I_{\text{OS}}$	Input Offset Current		0.6	40 <b>50</b>	nA max
CMRR	Common Mode Rejection Ratio	$0\text{V} \leq V_{\text{CM}} \leq 4\text{V}$	71	50	dB min
PSRR	Power Supply Rejection Ratio	$2.7\text{V} \leq V^+ \leq 5\text{V}$ $V_O = 1\text{V}$ , $V_{\text{CM}} = 1\text{V}$	65	50	dB min
$V_{\text{CM}}$	Input Common-Mode Voltage Range	For CMRR $\geq 50\text{dB}$	-0.2	0	V min
			4.2	4	V max
$A_V$	Large Signal Voltage Gain (Note 8)	$R_L = 100\text{k}\Omega$	100	15 <b>10</b>	V/mV min
$V_O$	Output Swing	$R_L = 100\text{k}\Omega$ to $2.5\text{V}$	$V^+ - 3.5$	$V^+ - 100$ <b><math>V^+ - 200</math></b>	mV min
			90	180 <b>220</b>	mV max
$I_O$	Output Short Circuit Current	Sourcing, $V_O = 0\text{V}$	17	2	mA min
		Sinking, $V_O = 5\text{V}$	72	20	mA min
$I_S$	Supply Current	LPV321	9	12 <b>15</b>	$\mu\text{A}$ max
		LPV358 Both amplifiers	15	20 <b>24</b>	$\mu\text{A}$ max
		LPV324 All four amplifiers	28	42 <b>46</b>	$\mu\text{A}$ max

## 5V AC Electrical Characteristics

Unless otherwise specified, all limits guaranteed for  $T_J = 25^\circ\text{C}$ ,  $V^+ = 5\text{V}$ ,  $V^- = 0\text{V}$ ,  $V_{\text{CM}} = 2.0\text{V}$ ,  $V_O = V^+/2$  and  $R_L > 1\text{ M}\Omega$ . **Boldface** limits apply at the temperature extremes.

Symbol	Parameter	Conditions	Typ (Note 6)	Limit (Note 7)	Units
SR	Slew Rate	(Note 9)	0.1		V/ $\mu\text{s}$
GBWP	Gain-Bandwidth Product	$C_L = 22\text{ pF}$	152		KHz
$\Phi_m$	Phase Margin		87		Deg
$G_m$	Gain Margin		19		dB
$e_n$	Input-Referred Voltage Noise	$f = 1\text{ kHz}$ ,	146		$\frac{\text{nV}}{\sqrt{\text{Hz}}}$
$i_n$	Input-Referred Current Noise	$f = 1\text{ kHz}$	0.30		$\frac{\text{pA}}{\sqrt{\text{Hz}}}$

**Note 1:** Absolute Maximum Ratings indicate limits beyond which damage to the device may occur. Operating Ratings indicate conditions for which the device is intended to be functional, but specific performance is not guaranteed. For guaranteed specifications and the test conditions, see the Electrical Characteristics.

**Note 2:** Human body model, 1.5 k $\Omega$  in series with 100 pF. Machine model, 0 $\Omega$  in series with 200 pF.

**Note 3:** Shorting output to  $V^+$  will adversely affect reliability.

**Note 4:** Shorting output to  $V^-$  will adversely affect reliability.

**Note 5:** The maximum power dissipation is a function of  $T_{J(\text{max})}$ ,  $\theta_{JA}$ , and  $T_A$ . The maximum allowable power dissipation at any ambient temperature is  $P_D = (T_{J(\text{max})} - T_A) / \theta_{JA}$ . All numbers apply for packages soldered directly into a PC board.

**Note 6:** Typical values represent the most likely parametric norm.

**Note 7:** All limits are guaranteed by testing or statistical analysis.

**Note 8:**  $R_L$  is connected to  $V^-$ . The output voltage is  $0.5\text{V} \leq V_O \leq 4.5\text{V}$ .

**Note 9:** Connected as voltage follower with 3V step input. Number specified is the slower of the positive and negative slew rates.

**Note 10:** All numbers are typical, and apply for packages soldered directly onto a PC board in still air.

**Typical Performance Characteristics** Unless otherwise specified,  $V_S = +5V$ , single supply,  $T_A = 25^\circ C$ .

**Supply Current vs Supply Voltage (LPV321)**

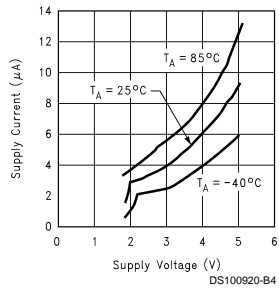

**Input Current vs Temperature**

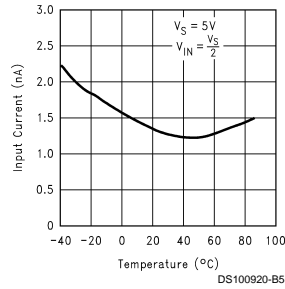

**Sourcing Current vs Output Voltage**

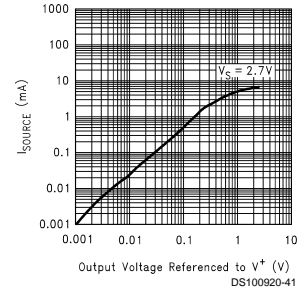

**Sourcing Current vs Output Voltage**

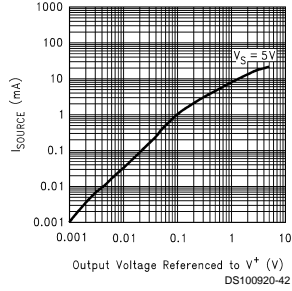

**Sinking Current vs Output Voltage**

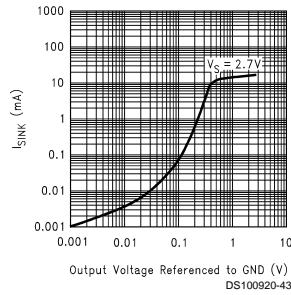

**Sinking Current vs Output Voltage**

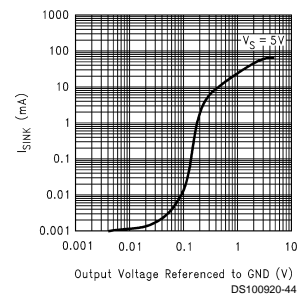

**Output Voltage Swing vs Supply Voltage**

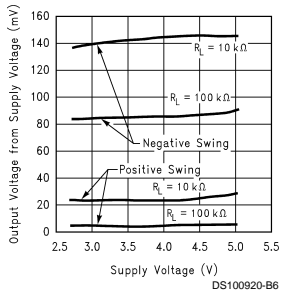

**Input Voltage Noise vs Frequency**

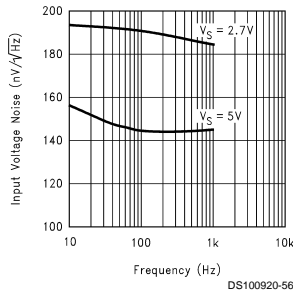

**Input Current Noise vs Frequency**

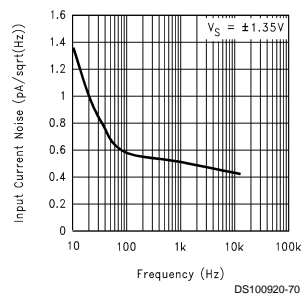

**Typical Performance Characteristics** Unless otherwise specified,  $V_S = +5V$ , single supply,  $T_A = 25^\circ C$ . (Continued)

**Input Current Noise vs Frequency**

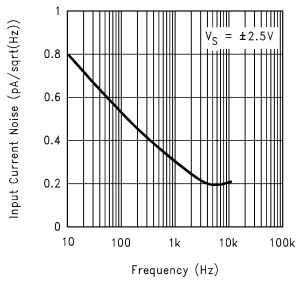

DS100920-68

**Crosstalk Rejection vs Frequency**

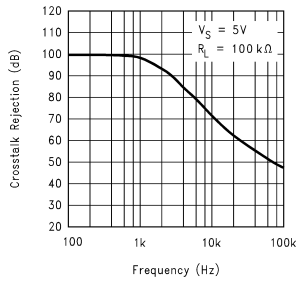

DS100920-73

**PSRR vs Frequency**

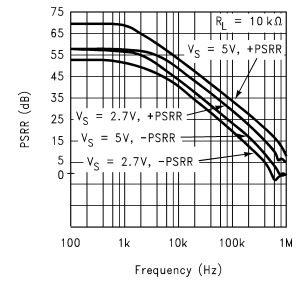

DS100920-72

**CMRR vs Frequency**

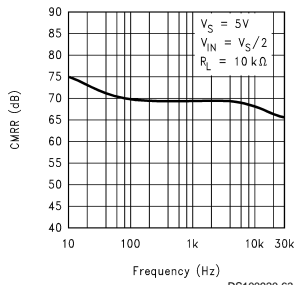

DS100920-63

**CMRR vs Input Common Mode Voltage**

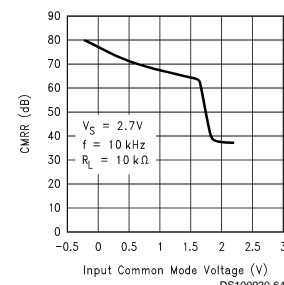

DS100920-64

**CMRR vs Input Common Mode Voltage**

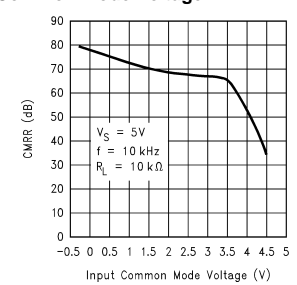

DS100920-65

**$\Delta V_{OS}$  vs CMR**

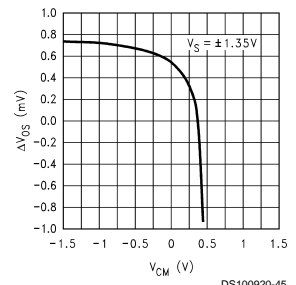

DS100920-45

**$\Delta V_{OS}$  vs CMR**

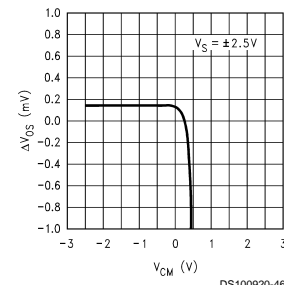

DS100920-46

**Input Voltage vs Output Voltage**

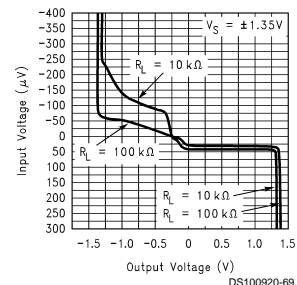

DS100920-69

**Typical Performance Characteristics** Unless otherwise specified,  $V_S = +5V$ , single supply,  $T_A = 25^\circ C$ . (Continued)

**Input Voltage vs Output Voltage**

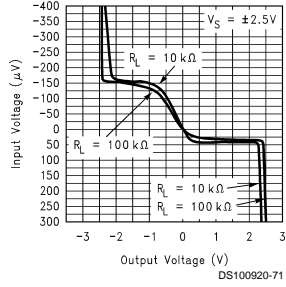

**Open Loop Frequency Response**

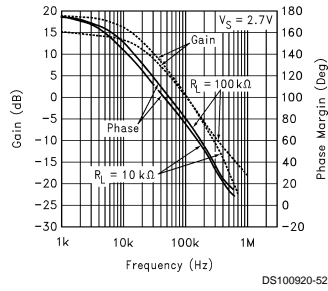

**Open Loop Frequency Response**

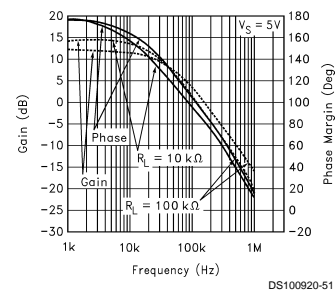

**Gain and Phase vs Capacitive Load**

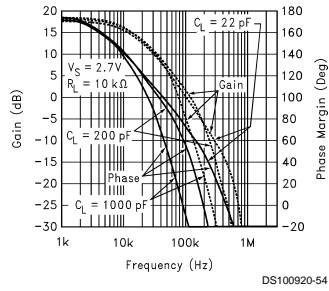

**Gain and Phase vs Capacitive Load**

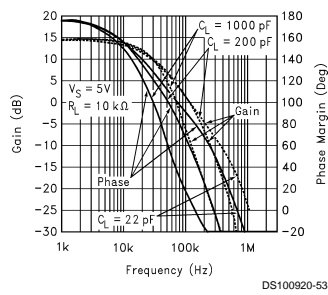

**Slew Rate vs Supply Voltage**

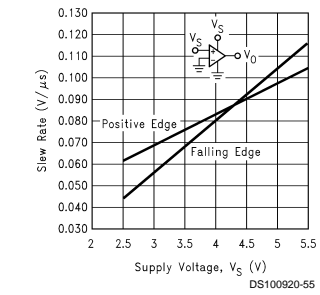

**Non-Inverting Large Signal Pulse Response**

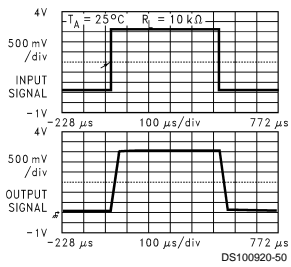

**Non-Inverting Small Signal Pulse Response**

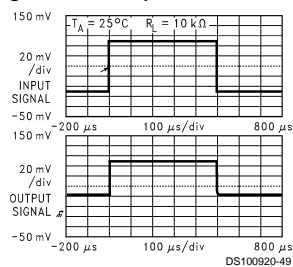

**Inverting Large Signal Pulse Response**

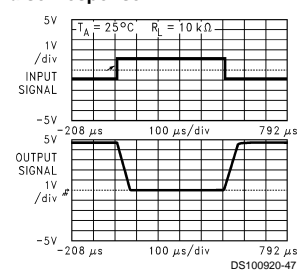



**Typical Performance Characteristics** Unless otherwise specified,  $V_S = +5V$ , single supply,  $T_A = 25^\circ C$ . (Continued)

**Inverting Small Signal Pulse Response**

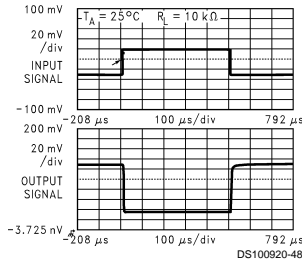

**Stability vs Capacitive Load**

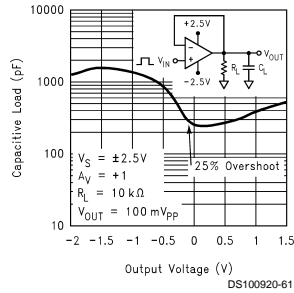

**Stability vs Capacitive Load**

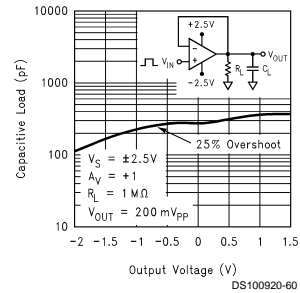

**Stability vs Capacitive Load**

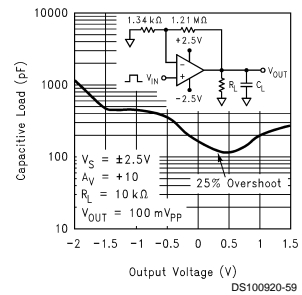

**Stability vs Capacitive Load**

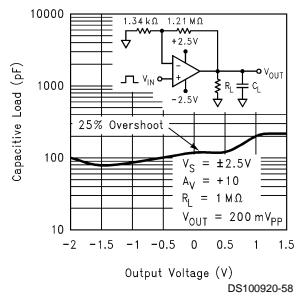

**THD vs Frequency**

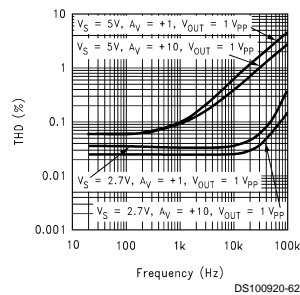

**Open Loop Output Impedance vs Frequency**

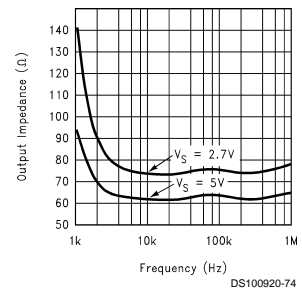

**Short Circuit Current vs Temperature (Sinking)**

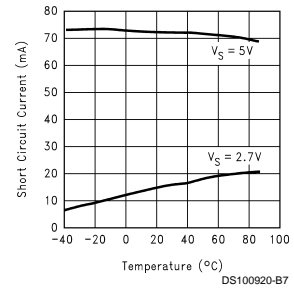

**Short Circuit Current vs Temperature (Sourcing)**

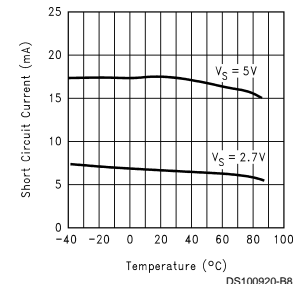

**Application Notes**

**1.0 Benefits of the LPV321/358/324**

**Size.** The small footprints of the LPV321/358/324 packages save space on printed circuit boards, and enable the design of smaller electronic products, such as cellular phones, pagers, or other portable systems. The low profile of the LPV321/358/324 make them possible to use in PCMCIA type III cards.

**Signal Integrity.** Signals can pick up noise between the signal source and the amplifier. By using a physically smaller

amplifier package, the LPV321/358/324 can be placed closer to the signal source, reducing noise pickup and increasing signal integrity.

**Simplified Board Layout.** These products help you to avoid using long pc traces in your pc board layout. This means that no additional components, such as capacitors and resistors, are needed to filter out the unwanted signals due to the interference between the long pc traces.

**Low Supply Current.** These devices will help you to maximize battery life. They are ideal for battery powered systems.

## Application Notes (Continued)

**Low Supply Voltage.** National provides guaranteed performance at 2.7V and 5V. These guarantees ensure operation throughout the battery lifetime.

**Rail-to-Rail Output.** Rail-to-rail output swing provides maximum possible dynamic range at the output. This is particularly important when operating on low supply voltages.

**Input Includes Ground.** Allows direct sensing near GND in single supply operation.

The differential input voltage may be larger than  $V^+$  without damaging the device. Protection should be provided to prevent the input voltages from going negative more than  $-0.3V$  (at  $25^\circ C$ ). An input clamp diode with a resistor to the IC input terminal can be used.

### 2.0 Capacitive Load Tolerance

The LPV321/358/324 can directly drive 200 pF in unity-gain without oscillation. The unity-gain follower is the most sensitive configuration to capacitive loading. Direct capacitive loading reduces the phase margin of amplifiers. The combination of the amplifier's output impedance and the capacitive load induces phase lag. This results in either an underdamped pulse response or oscillation. To drive a heavier capacitive load, circuit in *Figure 1* can be used.

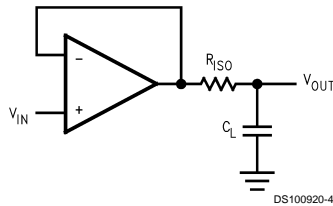

**FIGURE 1. Indirectly Driving A Capacitive Load Using Resistive Isolation**

In *Figure 1*, the isolation resistor  $R_{ISO}$  and the load capacitor  $C_L$  form a pole to increase stability by adding more phase margin to the overall system. The desired performance depends on the value of  $R_{ISO}$ . The bigger the  $R_{ISO}$  resistor value, the more stable  $V_{OUT}$  will be. *Figure 2* is an output waveform of *Figure 1* using  $100k\Omega$  for  $R_{ISO}$  and  $1000pF$  for  $C_L$ .

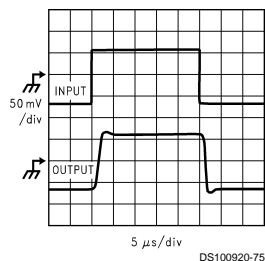

**FIGURE 2. Pulse Response of the LPV324 Circuit in Figure 1**

The circuit in *Figure 3* is an improvement to the one in *Figure 1* because it provides DC accuracy as well as AC stability. If there were a load resistor in *Figure 1*, the output would be voltage divided by  $R_{ISO}$  and the load resistor. Instead, in *Figure 3*,  $R_F$  provides the DC accuracy by using feed-forward techniques to connect  $V_{IN}$  to  $R_L$ . Caution is needed in choos-

ing the value of  $R_F$  due to the input bias current of the LPV321/358/324.  $C_F$  and  $R_{ISO}$  serve to counteract the loss of phase margin by feeding the high frequency component of the output signal back to the amplifier's inverting input, thereby preserving phase margin in the overall feedback loop. Increased capacitive drive is possible by increasing the value of  $C_F$ . This in turn will slow down the pulse response.

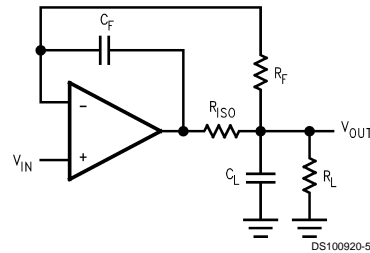

**FIGURE 3. Indirectly Driving A Capacitive Load with DC Accuracy**

### 3.0 Input Bias Current Cancellation

The LPV321/358/324 family has a bipolar input stage. The typical input bias current of LPV321/358/324 is  $1.5nA$  with  $5V$  supply. Thus a  $100k\Omega$  input resistor will cause  $0.15mV$  of error voltage. By balancing the resistor values at both inverting and non-inverting inputs, the error caused by the amplifier's input bias current will be reduced. The circuit in *Figure 4* shows how to cancel the error caused by input bias current.

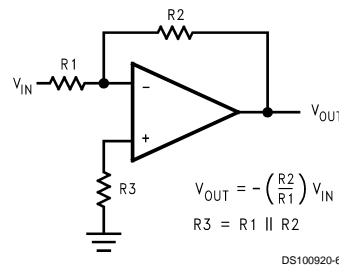

**FIGURE 4. Cancelling the Error Caused by Input Bias Current**

### 4.0 Typical Single-Supply Application Circuits

#### 4.1 Difference Amplifier

The difference amplifier allows the subtraction of two voltages or, as a special case, the cancellation of a signal common to two inputs. It is useful as a computational amplifier, in making a differential to single-ended conversion or in rejecting a common mode signal.

## Application Notes (Continued)

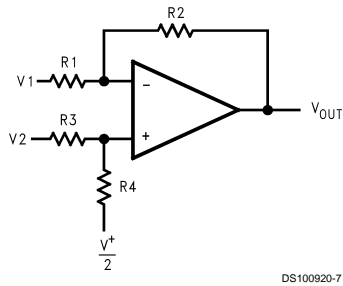

DS100920-7

$$V_{OUT} = \left( \frac{R1+R2}{R3+R4} \right) \frac{R4}{R1} V_2 - \frac{R2}{R1} V_1 + \left( \frac{R1+R2}{R3+R4} \right) \frac{R3}{R1} \cdot \frac{V^+}{2}$$

for  $R1 = R3$  and  $R2 = R4$

$$V_{OUT} = \frac{R2}{R1} (V_2 - V_1) + \frac{V^+}{2}$$

**FIGURE 5. Difference Amplifier**

### 4.2 Instrumentation Circuits

The input impedance of the previous difference amplifier is set by the resistor  $R_1$ ,  $R_2$ ,  $R_3$ , and  $R_4$ . To eliminate the problems of low input impedance, one way is to use a voltage follower ahead of each input as shown in the following two instrumentation amplifiers.

#### 4.2.1 Three-op-amp Instrumentation Amplifier

The quad LPV324 can be used to build a three-op-amp instrumentation amplifier as shown in *Figure 6*

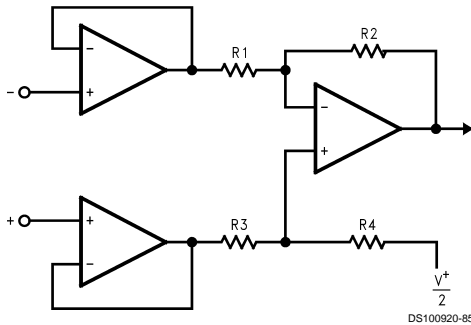

DS100920-85

**FIGURE 6. Three-op-amp Instrumentation Amplifier**

The first stage of this instrumentation amplifier is a differential-input, differential-output amplifier, with two voltage followers. These two voltage followers assure that the input impedance is over  $100M\Omega$ . The gain of this instrumentation amplifier is set by the ratio of  $R_2/R_1$ .  $R_3$  should equal  $R_1$  and  $R_4$  equal  $R_2$ . Matching of  $R_3$  to  $R_1$  and  $R_4$  to  $R_2$  affects the CMRR. For good CMRR over temperature, low drift resistors should be used. Making  $R_4$  slightly smaller than  $R_2$  and adding a trim pot equal to twice the difference between  $R_2$  and  $R_4$  will allow the CMRR to be adjusted for optimum.

#### 4.2.2 Two-op-amp Instrumentation Amplifier

A two-op-amp instrumentation amplifier can also be used to make a high-input-impedance DC differential amplifier (*Figure 7*). As in the three-op-amp circuit, this instrumentation amplifier requires precise resistor matching for good CMRR.  $R_4$  should equal to  $R_1$  and  $R_3$  should equal  $R_2$ .

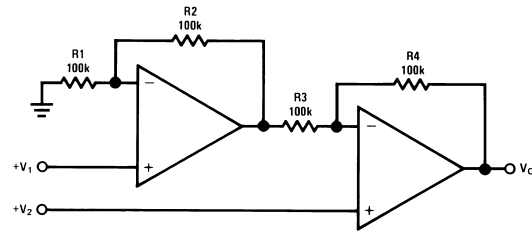

DS100920-11

$$V_O = \left( 1 + \frac{R4}{R3} \right) (V_2 - V_1), \text{ where } R1 = R4 \text{ and } R2 = R3$$

As shown:  $V_O = 2(V_2 - V_1)$

**FIGURE 7. Two-op-amp Instrumentation Amplifier**

#### 4.3 Single-Supply Inverting Amplifier

There may be cases where the input signal going into the amplifier is negative. Because the amplifier is operating in single supply voltage, a voltage divider using  $R_3$  and  $R_4$  is implemented to bias the amplifier so the input signal is within the input common-mode voltage range of the amplifier. The capacitor  $C_1$  is placed between the inverting input and resistor  $R_1$  to block the DC signal going into the AC signal source,  $V_{IN}$ . The values of  $R_1$  and  $C_1$  affect the cutoff frequency,  $f_c = 1/2\pi R_1 C_1$ .

As a result, the output signal is centered around mid-supply (if the voltage divider provides  $V^+/2$  at the non-inverting input). The output can swing to both rails, maximizing the signal-to-noise ratio in a low voltage system.

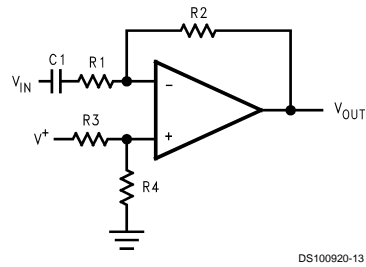

DS100920-13

$$V_{OUT} = -\frac{R2}{R1} V_{IN}$$

**FIGURE 8. Single-Supply Inverting Amplifier**

### 4.4 Active Filter

#### 4.4.1 Simple Low-Pass Active Filter

The simple low-pass filter is shown in *Figure 9*. Its low-frequency gain ( $\omega \rightarrow 0$ ) is defined by  $-R_3/R_1$ . This allows low-frequency gains other than unity to be obtained. The filter has a  $-20\text{dB/decade}$  roll-off after its corner frequency  $f_c$ .  $R_2$  should be chosen equal to the parallel combination of  $R_1$  and  $R_3$  to minimize errors due to bias current. The frequency response of the filter is shown in *Figure 10*

## Application Notes (Continued)

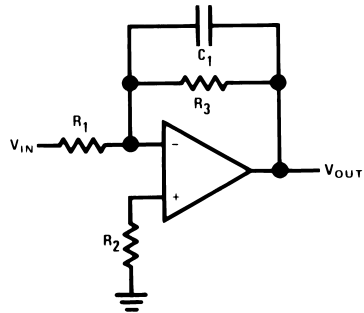

DS100920-14

$$A_L = -\frac{R_3}{R_1}$$

$$f_c = \frac{1}{2\pi R_3 C_1}$$

$$R_2 = R_1 \parallel R_3$$

**FIGURE 9. Simple Low-Pass Active Filter**

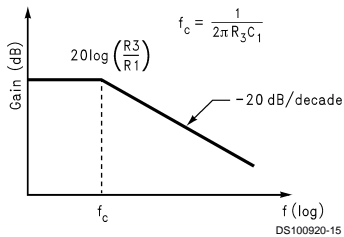

DS100920-15

**FIGURE 10. Frequency Response of Simple Low-pass Active Filter in Figure 9**

Note that the single-op-amp active filters are used in to the applications that require low quality factor,  $Q (\leq 10)$ , low frequency ( $\leq 5\text{KHz}$ ), and low gain ( $\leq 10$ ), or a small value for the product of gain times  $Q (\leq 100)$ . The op amp should have an open loop voltage gain at the highest frequency of interest at least 50 times larger than the gain of the filter at this frequency. In addition, the selected op amp should have a slew rate that meets the following requirement:

$$\text{SlewRate} \geq 0.5 \times (\omega_H V_{\text{OPP}}) \times 10^{-6} \text{V}/\mu\text{sec}$$

Where  $\omega_H$  is the highest frequency of interest, and  $V_{\text{OPP}}$  is the output peak-to-peak voltage.

## SC70-5 Tape and Reel Specification

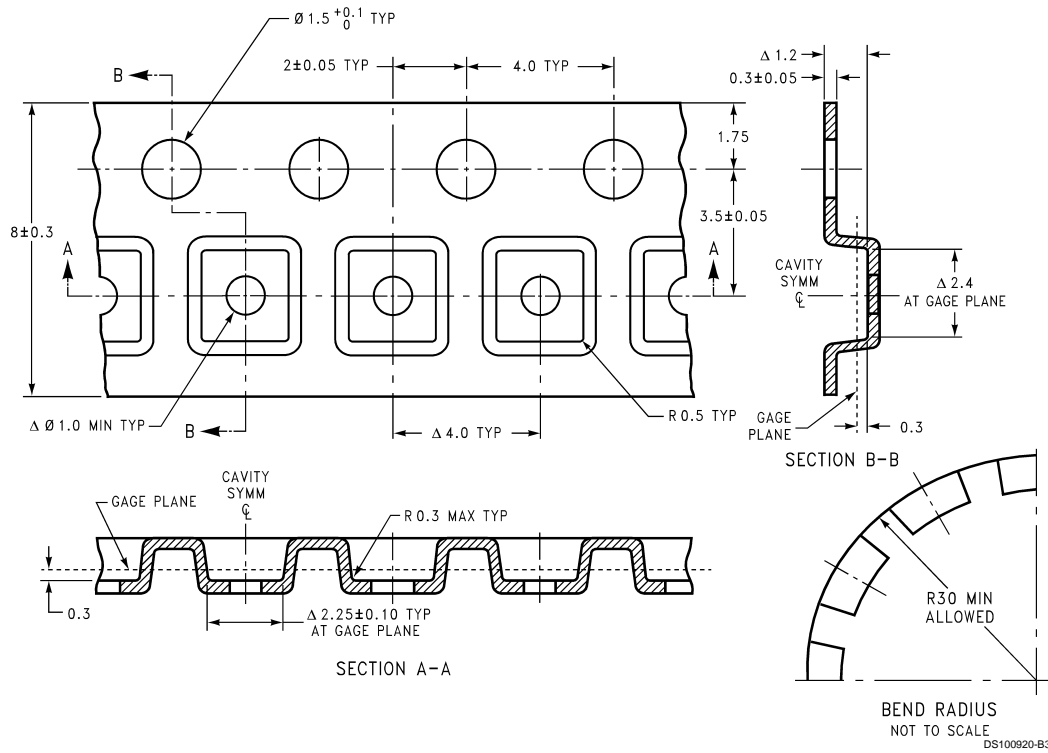

## SOT-23-5 Tape and Reel Specification

### TAPE FORMAT

Tape Section	# Cavities	Cavity Status	Cover Tape Status
Leader (Start End)	0 (min)	Empty	Sealed
	75 (min)	Empty	Sealed
Carrier	3000	Filled	Sealed
	250	Filled	Sealed
Trailer (Hub End)	125 (min)	Empty	Sealed
	0 (min)	Empty	Sealed

## SOT-23-5 Tape and Reel Specification (Continued)

### TAPE DIMENSIONS

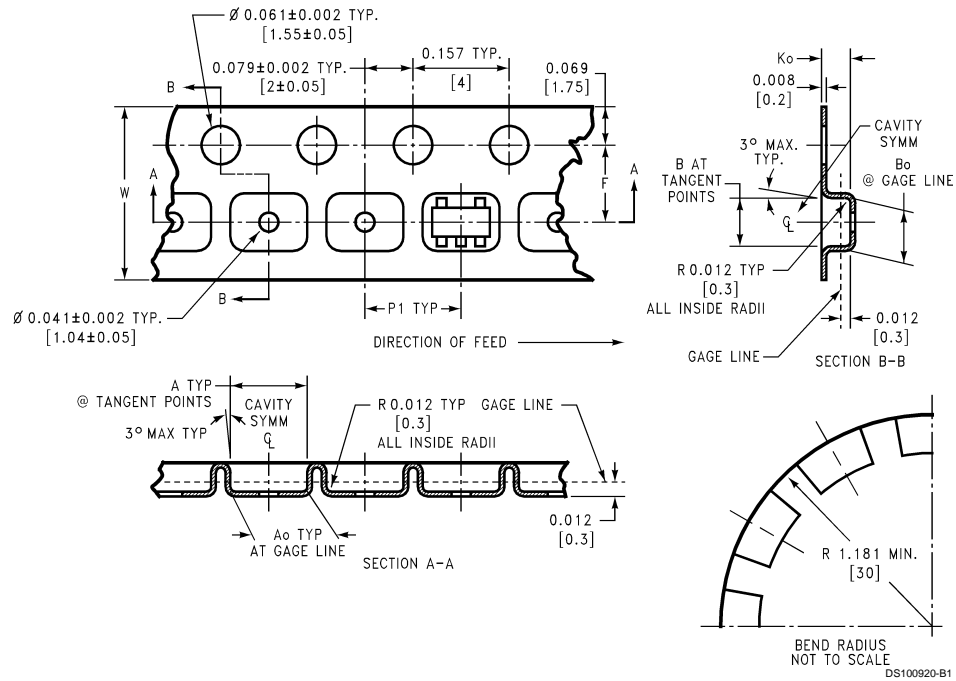

<b>8 mm</b>	<b>0.130</b>	<b>0.124</b>	<b>0.130</b>	<b>0.126</b>	<b>0.138 ± 0.002</b>	<b>0.055 ± 0.004</b>	<b>0.157</b>	<b>0.315 ± 0.012</b>
	<b>(3.3)</b>	<b>(3.15)</b>	<b>(3.3)</b>	<b>(3.2)</b>	<b>(3.5 ± 0.05)</b>	<b>(1.4 ± 0.11)</b>	<b>(4)</b>	<b>(8 ± 0.3)</b>
Tape Size	DIM A	DIM Ao	DIM B	DIM Bo	DIM F	DIM Ko	DIM P1	DIM W

## SOT-23-5 Tape and Reel Specification (Continued)

### REEL DIMENSIONS

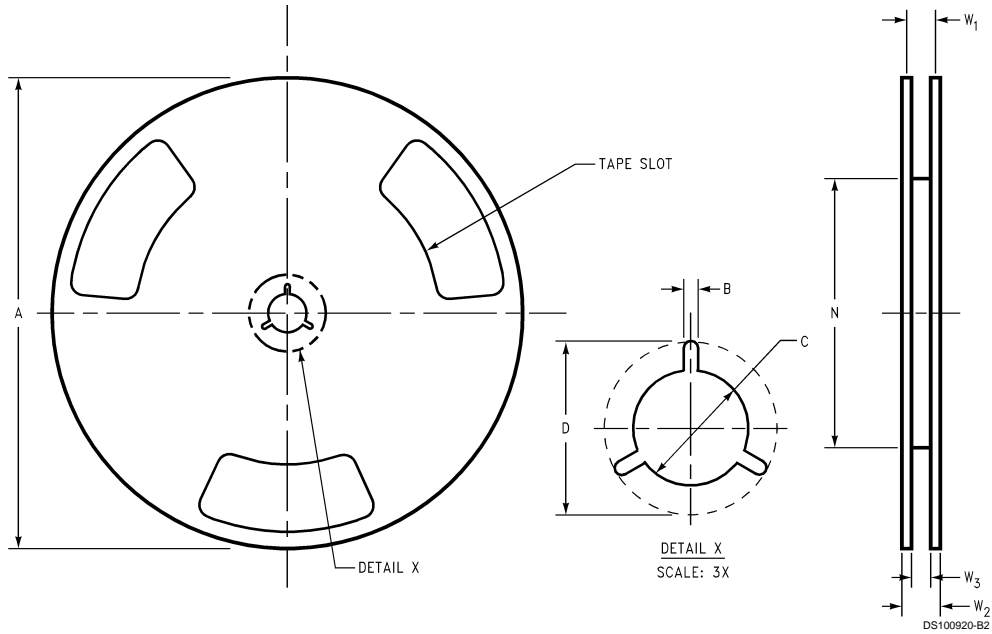

8 mm	7.00	0.059	0.512	0.795	2.165	0.331 + 0.059/-0.000	0.567	W1 + 0.078/-0.039
	330.00	1.50	13.00	20.20	55.00	8.40 + 1.50/-0.00	14.40	W1 + 2.00/-1.00
Tape Size	A	B	C	D	N	W1	W2	W3

**Physical Dimensions** inches (millimeters) unless otherwise noted

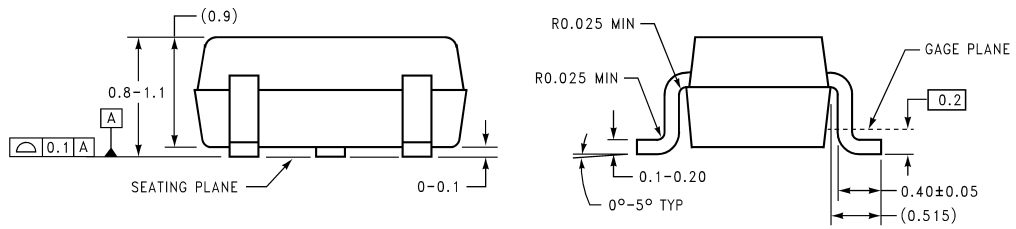
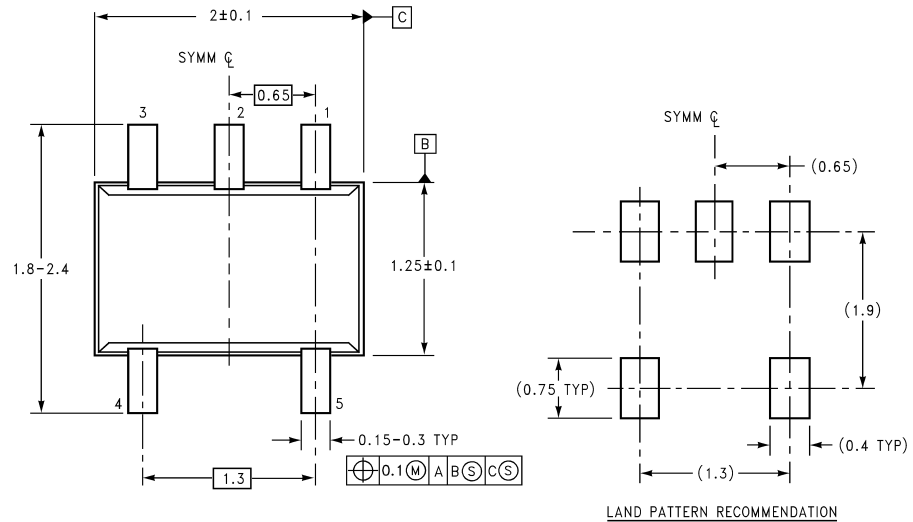

DIMENSIONS ARE IN MILLIMETERS

MAA05A (REV B)

**5-Pin SC70-5 Tape and Reel**  
**Order Number LPV321M7 and LPV321M7X**  
**NS Package Number MAA05A**



**Physical Dimensions** inches (millimeters) unless otherwise noted (Continued)

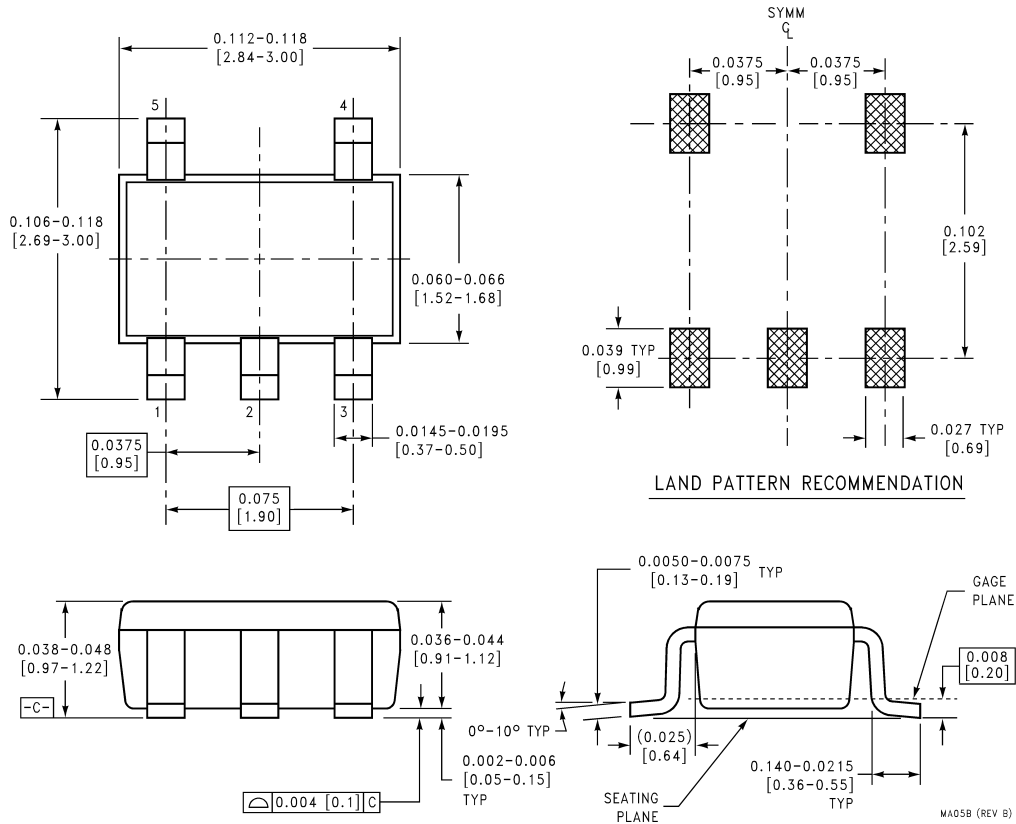

**5-Pin SOT23-5 Tape and Reel**  
**Order Number LPV321M5 and LPV321M5X**  
**NS Package Number MA05B**

**Physical Dimensions** inches (millimeters) unless otherwise noted (Continued)

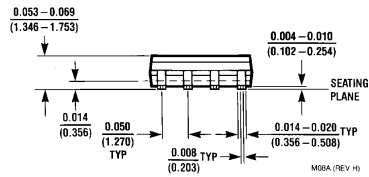
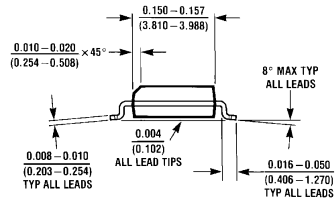
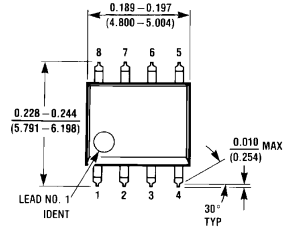

**8-Pin Small Outline**  
**Order Number LPV358M and LPV358MX**  
**NS Package Number M08A**

**Physical Dimensions** inches (millimeters) unless otherwise noted (Continued)

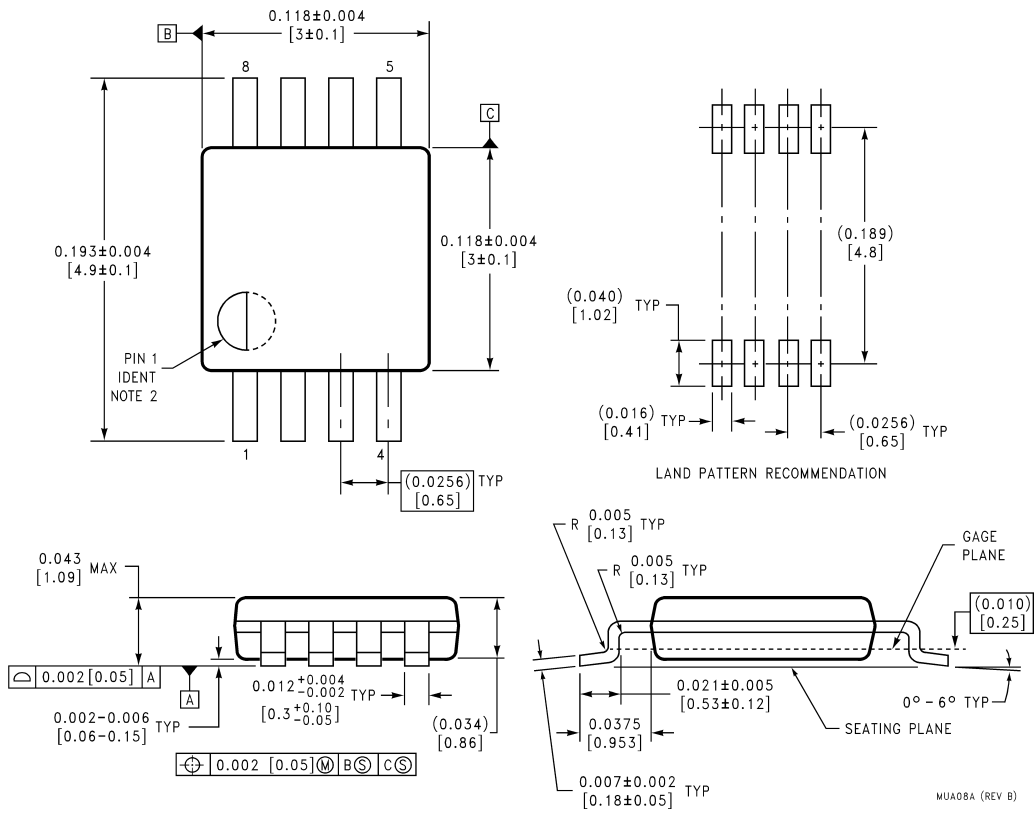

**8-Pin MSOP**  
**Order Number LPV358MM and LPV358MMX**  
**NS Package Number MUA08A**

MUA08A (REV B)

**Physical Dimensions** inches (millimeters) unless otherwise noted (Continued)

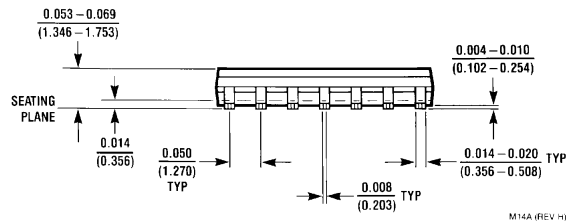
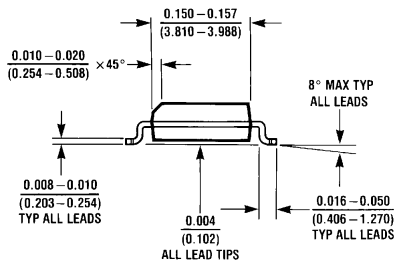
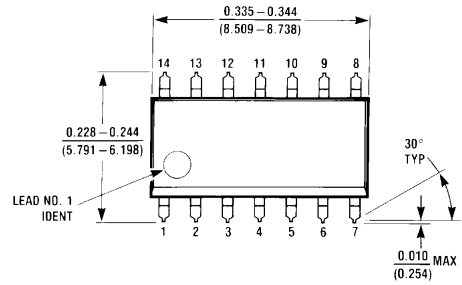

**14-Pin Small Outline**  
**Order Number LPV324M and LPV324MX**  
**NS Package Number M14A**

M14A (REV H)

**Physical Dimensions** inches (millimeters) unless otherwise noted (Continued)

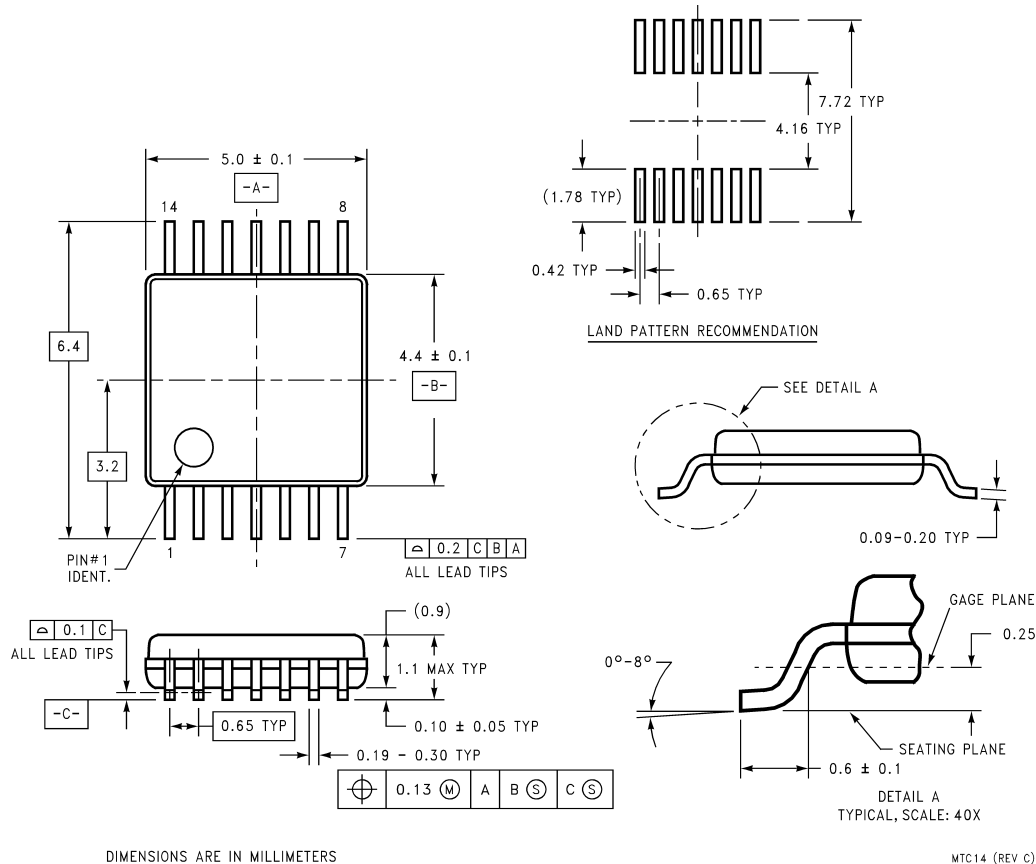

**14-Pin TSSOP**  
**Order Number LPV324MT and LPV324MTX**  
**NS Package Number MTC14**

**LIFE SUPPORT POLICY**

NATIONAL'S PRODUCTS ARE NOT AUTHORIZED FOR USE AS CRITICAL COMPONENTS IN LIFE SUPPORT DEVICES OR SYSTEMS WITHOUT THE EXPRESS WRITTEN APPROVAL OF THE PRESIDENT AND GENERAL COUNSEL OF NATIONAL SEMICONDUCTOR CORPORATION. As used herein:

1. Life support devices or systems are devices or systems which, (a) are intended for surgical implant into the body, or (b) support or sustain life, and whose failure to perform when properly used in accordance with instructions for use provided in the labeling, can be reasonably expected to result in a significant injury to the user.
2. A critical component is any component of a life support device or system whose failure to perform can be reasonably expected to cause the failure of the life support device or system, or to affect its safety or effectiveness.

**National Semiconductor Corporation**  
 Americas  
 Tel: 1-800-272-9959  
 Fax: 1-800-737-7018  
 Email: support@nsc.com  
 www.national.com

**National Semiconductor Europe**  
 Fax: +49 (0) 1 80-530 85 86  
 Email: europe.support@nsc.com  
 Deutsch Tel: +49 (0) 1 80-530 85 85  
 English Tel: +49 (0) 1 80-532 78 32  
 Français Tel: +49 (0) 1 80-532 93 58  
 Italiano Tel: +49 (0) 1 80-534 16 80

**National Semiconductor Asia Pacific Customer Response Group**  
 Tel: 65-2544466  
 Fax: 65-2504466  
 Email: sea.support@nsc.com

**National Semiconductor Japan Ltd.**  
 Tel: 81-3-5639-7560  
 Fax: 81-3-5639-7507

National does not assume any responsibility for use of any circuitry described, no circuit patent licenses are implied and National reserves the right at any time without notice to change said circuitry and specifications.