

M5239L

SINGLE COMPARATOR

DESCRIPTION

The M5239L is a semiconductor circuit for a comparator designed to operate over a wide supply voltage range from 2 to 36V from a single power supply in 5-pin SIP.

A differential circuit which is equivalent to a conventional single power supply operational amplifier is used to enable operation from GND level to improve input characteristics. Power dissipation (circuit current) is low and output voltage is large.

It fits to a general-purpose comparator for a variety to electronic equipment.

FEATURES

- Wide operating supply voltage range 2V ~ 36V
Dual power supplies : $\pm 1V \sim \pm 18V$
- Low circuit current 0.45mA
- Wide common mode input voltage range
. 0V ~ $V_{CC} - 1.5V$ (single power supply)
- Open collector output
- Output sink current 25mA
- Response time 1.3 μ sec

APPLICATION

Voltage comparator, window comparator, CR timer, time delay circuit, oscillator, etc.

PIN CONFIGURATION (TOP VIEW)

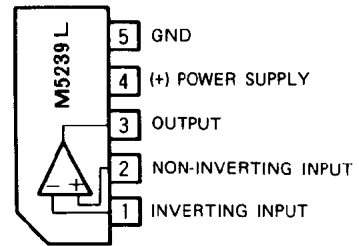

Outline 5P5T

EQUIVALENT CIRCUIT DIAGRAM

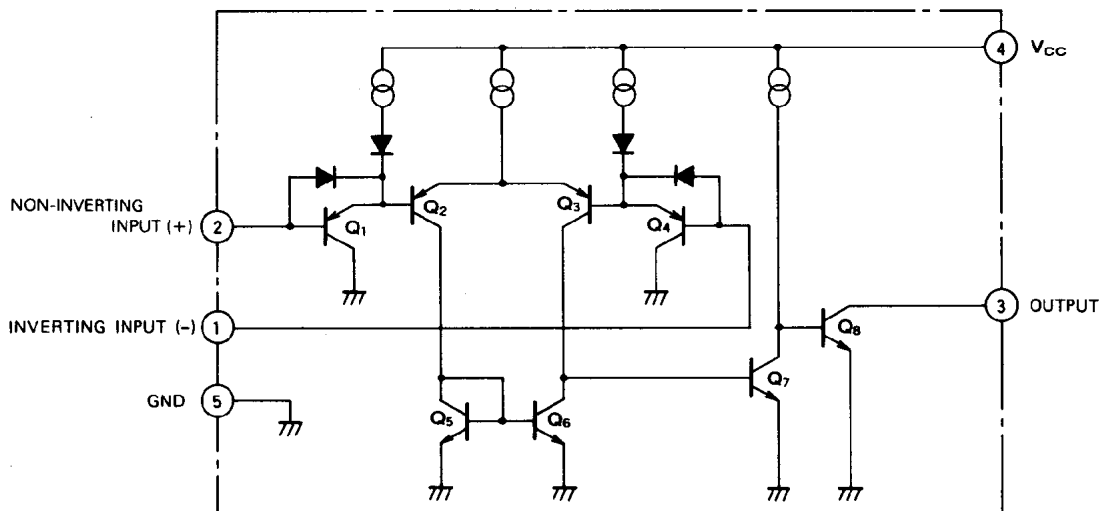

SINGLE COMPARATOR

ABSOLUTE MAXIMUM RATINGS (Ta = 25°C, unless otherwise noted)

Symbol	Parameter	Conditions	Ratings	Unit
V _{CC}	Supply voltage		36 (±18)	V
V _{ID}	Differential input voltage		36	V
V _{ICM}	Common mode input voltage range		-0.3 ~ +36	V
P _d	Power dissipation		450	mW
T _{opr}	Operating temperature		-20 ~ +75	°C
T _{stg}	Storage temperature		-55 ~ +125	°C

ELECTRICAL CHARACTERISTICS (Ta = 25°C, V_{CC} = 5V, unless otherwise noted)

Symbol	Parameter	Test conditions	Limits			Unit
			Min	Typ	Max	
V _{IO}	Input offset voltage	V _O = 1.4V, V _{REF} = 1.4V, R _S = 0Ω	—	2	5	mV
I _{IO}	Input offset current		—	5	50	nA
I _B	Input bias current		—	25	250	nA
V _{ICM}	Common mode input voltage range		0	—	V _{CC} -1.5	V
G _V	Voltage gain	R _L = 15kΩ	—	200	—	V/mV
I _{CC}	Circuit current	R _L = ∞	—	0.45	0.75	mA
t _{PLH}	Response time	R _L = 5.1kΩ, V _{RL} = 5V	—	1.3	—	μsec
I _{SINK}	Output sink current	V _{IN(-)} = 1V, V _{IN(+)} = 0V, V _O ≤ 1.5V	10	25	—	mA
V _{OL}	Output saturation voltage	V _{IN(-)} = 1V, V _{IN(+)} = 0V, I _{SINK} = 4mA	—	200	400	mV
I _{OL}	Output leak current	V _{IN(+)} = 1V, V _{IN(-)} = 0V, V _O = 5V	—	0.1	—	nA

TYPICAL CHARACTERISTICS

**THERMAL DERATING
(MAXIMUM RATING)**

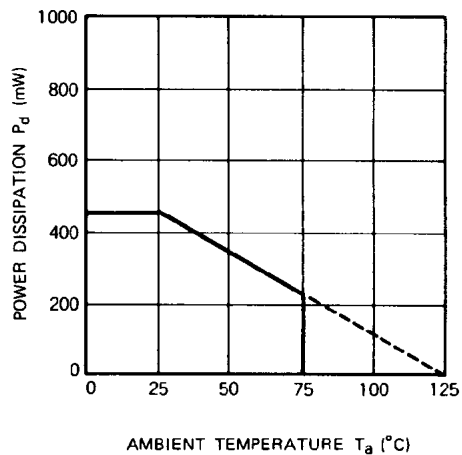

**CIRCUIT CURRENT VS.
SUPPLY VOLTAGE**

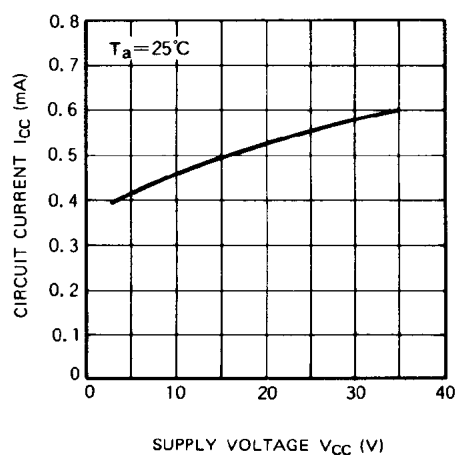

SINGLE COMPARATOR

INPUT BIAS CURRENT VS. SUPPLY VOLTAGE

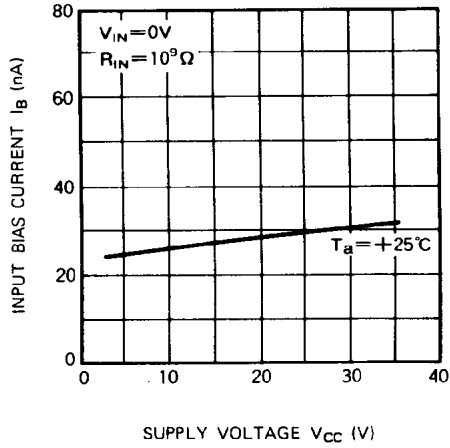

OUTPUT SATURATION VOLTAGE VS. OUTPUT SINK CURRENT

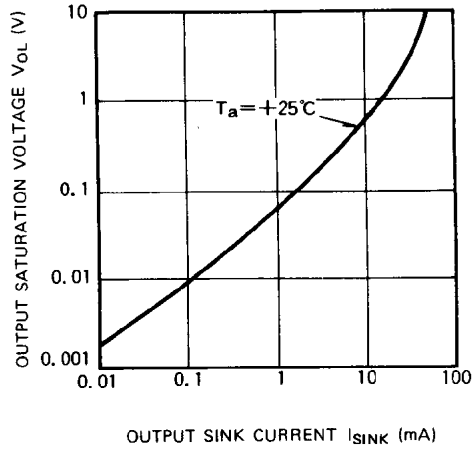

RESPONSE TIME FOR VARIOUS INPUT OVERDRIVES VS. NEGATIVE TRANSITION

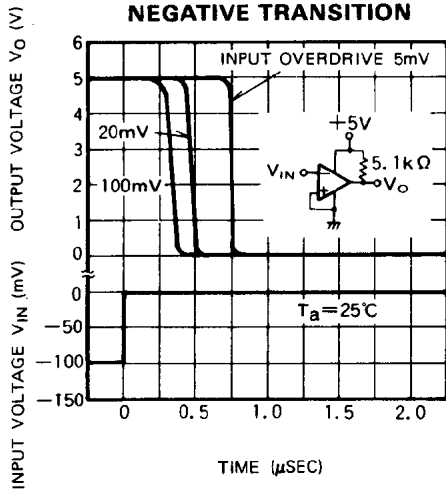

RESPONSE TIME FOR VARIOUS INPUT OVERDRIVES VS. NEGATIVE TRANSITION

