

I²C BUS Sound Processor for TV

Description

The CXA2021S is a bipolar IC developed as an I²C BUS control sound processor for TV. This IC implements surround, tone control, balance, volume, mute and AGC functions.

Features

- I²C BUS control
- The AGC circuit is adopted to absorb volume differences between input sources and improve the S/N ratio in hearing.

Absolute Maximum Ratings

- Supply voltage V_{CC} 14 V
- Operating temperature T_{opr} -20 to +75 °C
- Storage temperature T_{stg} -65 to +150 °C
- Allowable power dissipation P_D 0.9 W

Recommended Operating Condition

Supply voltage 8 to 13 V

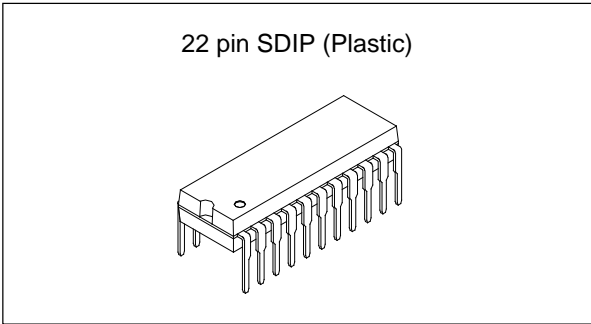

Structure

Bipolar silicon monolithic IC

Applications

TVs

Pin Configuration

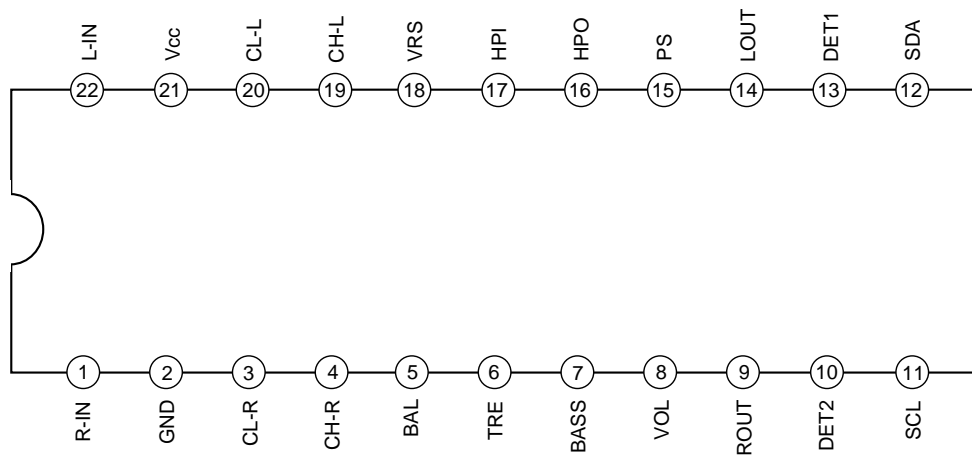

Sony reserves the right to change products and specifications without prior notice. This information does not convey any license by any implication or otherwise under any patents or other right. Application circuits shown, if any, are typical examples illustrating the operation of the devices. Sony cannot assume responsibility for any problems arising out of the use of these circuits.

Block Diagram

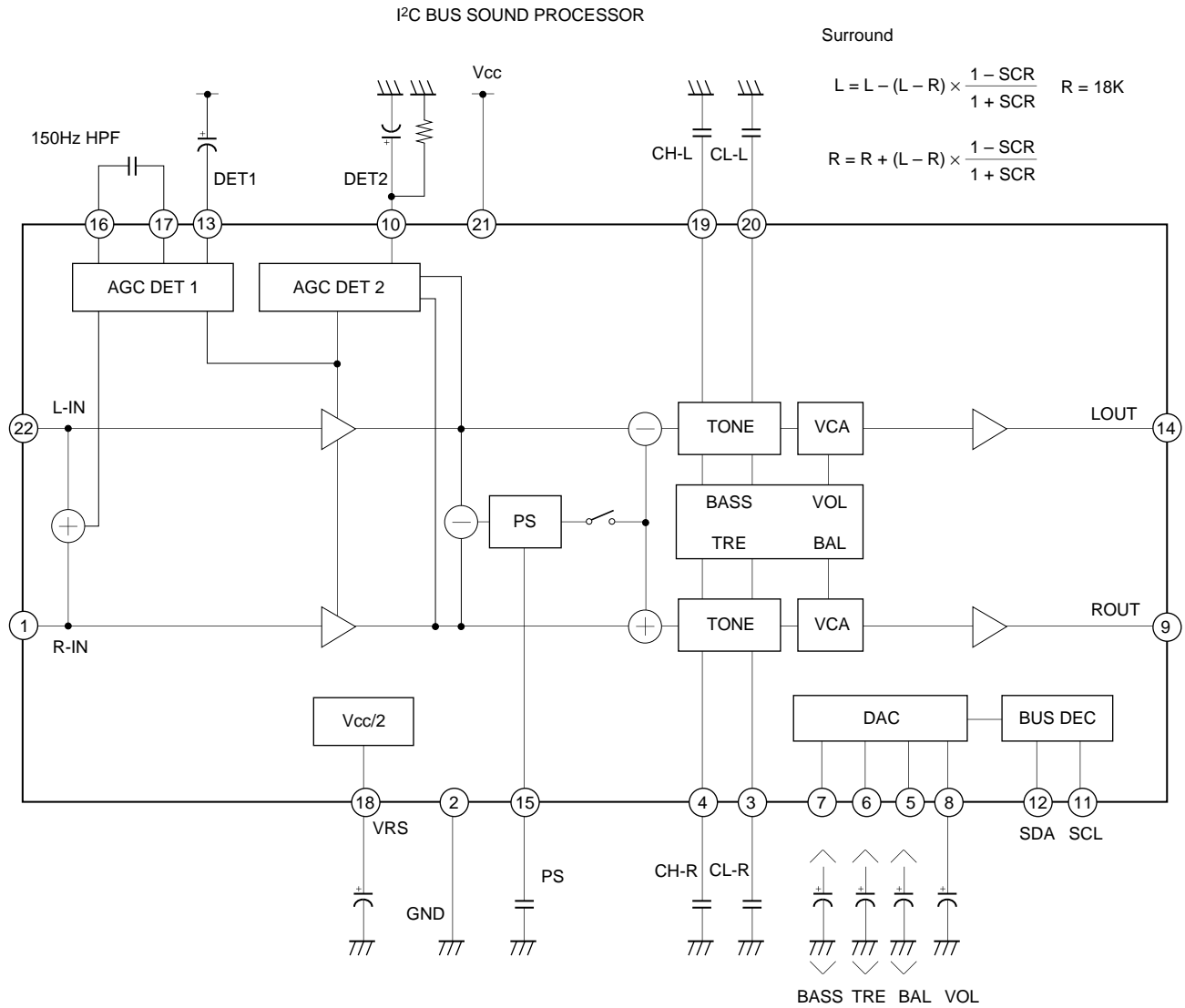

Pin Description

(Ta = 25°C, Vcc = 12V)

Pin No.	Symbol	Voltage	Equivalent circuit	Description
1 22	R-IN L-IN	6V		Input pins.
2	GND	0V		GND pin.
3 20	CL-R CL-L	6V		Pins for connecting external LPF capacitance (BASS).
4 19	CH-R CH-L	6V		Pins for connecting external HPF capacitance (TREBLE).
5 6 7 8	BAL TRE BASS VOL	4.5V		DAC output pins. Connect LPF capacitance of DAC. Internal impedance is approximately 20kΩ.

Pin No.	Symbol	Voltage	Equivalent circuit	Description
9 14	ROUT LOUT	6V		Output pins.
10	DET2			AGC detector output and control pin.
11	SCL			I ² C bus clock line.
12	SDA			I ² C bus data line.

Pin No.	Symbol	Voltage	Equivalent circuit	Description
13	DET1	7.8V		AGC detector output. Connect capacitance for setting time constant.
15	PS	6V		Pin for connecting external capacitance of the surround phase shifter. Internal impedance is approximately 18kΩ.
16	HPO	6V		AGC HPF output pin.
17	HPI	6V		AGC HPF input pin.

Pin No.	Symbol	Voltage	Equivalent circuit	Description
18	VRS	6V		$\frac{V_{CC}}{2}$ reference voltage pin.
21	Vcc	12V		Power supply pin.

Control Register Table SLAVE ADDRESS = 82H

DATA							
bit 7	bit 6	bit 5	bit 4	bit 3	bit 2	bit 1	bit 0
VOLUME (00)						MUTE (0)	AGC (0)
BASS (00)					*	MODE (0)	*
TREBLE (00)					*		
BALANCE (00)						*	

(Power-ON setting value)

AGC: 0 = OFF , 1 = ON
 MUTE: 0 = OFF , 1 = ON

<Description of registers>

- VOLUME: Volume control for both L channel and R channel
 00 = minimum value
 3F = maximum value
- MUTE: MUTE switch
 0 = Mute OFF
 1 = Mute ON (Mute state)
- AGC switch
 0 = AGC OFF
 1 = AGC ON
- BASS: Low-frequency control
 00 = Minimum value
 10 = Typical value
 1F = Maximum value
- MODE: Surround switch
 0 = Surround OFF
 1 = Surround ON
- TREBLE: High-frequency control
 00 = Minimum value
 10 = Typical value
 1F = Maximum value
- BALANCE: Balance control for L channel and R channel
 00 = L channel minimum, R channel maximum
 20 = Typical
 3F = L channel maximum, R channel minimum

Electrical Characteristics Measurement Circuit

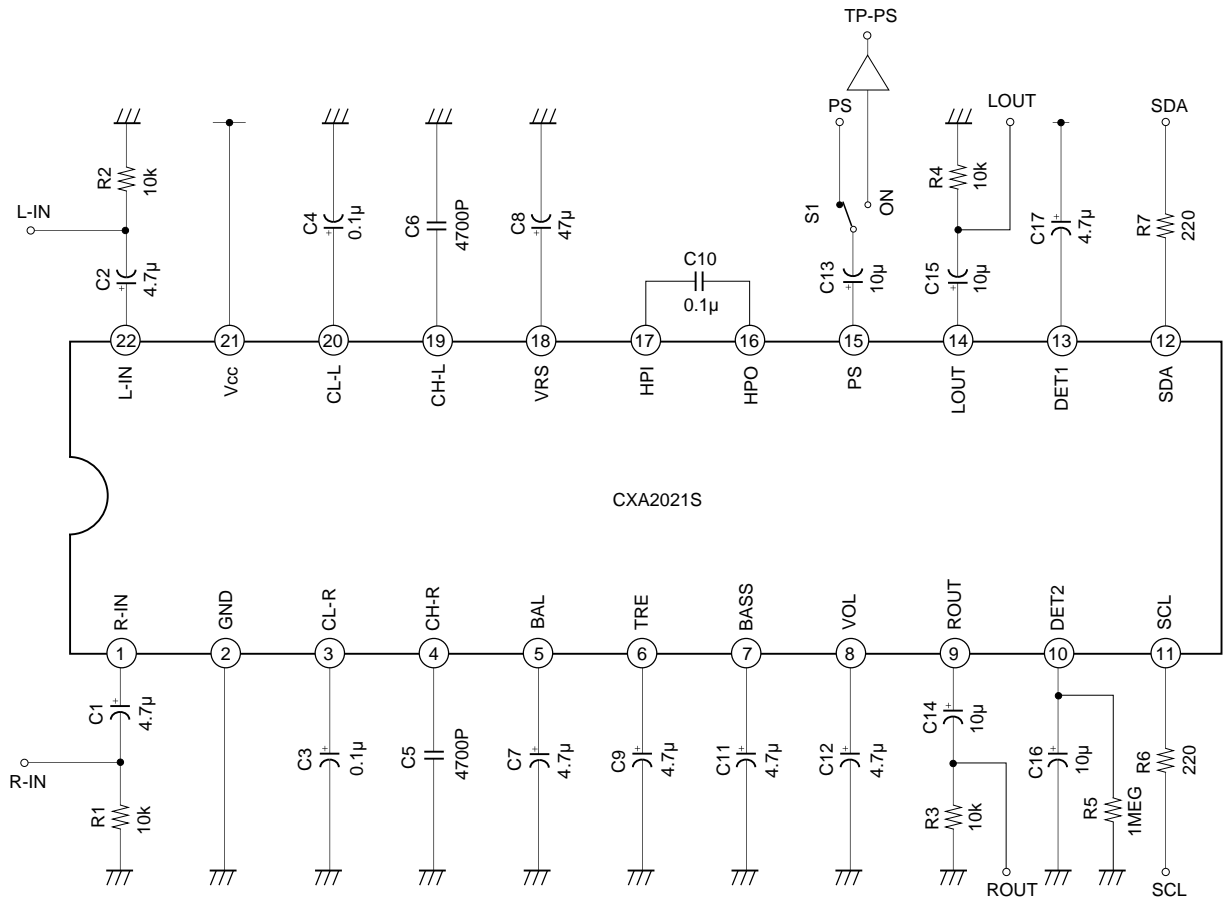

Application Circuit

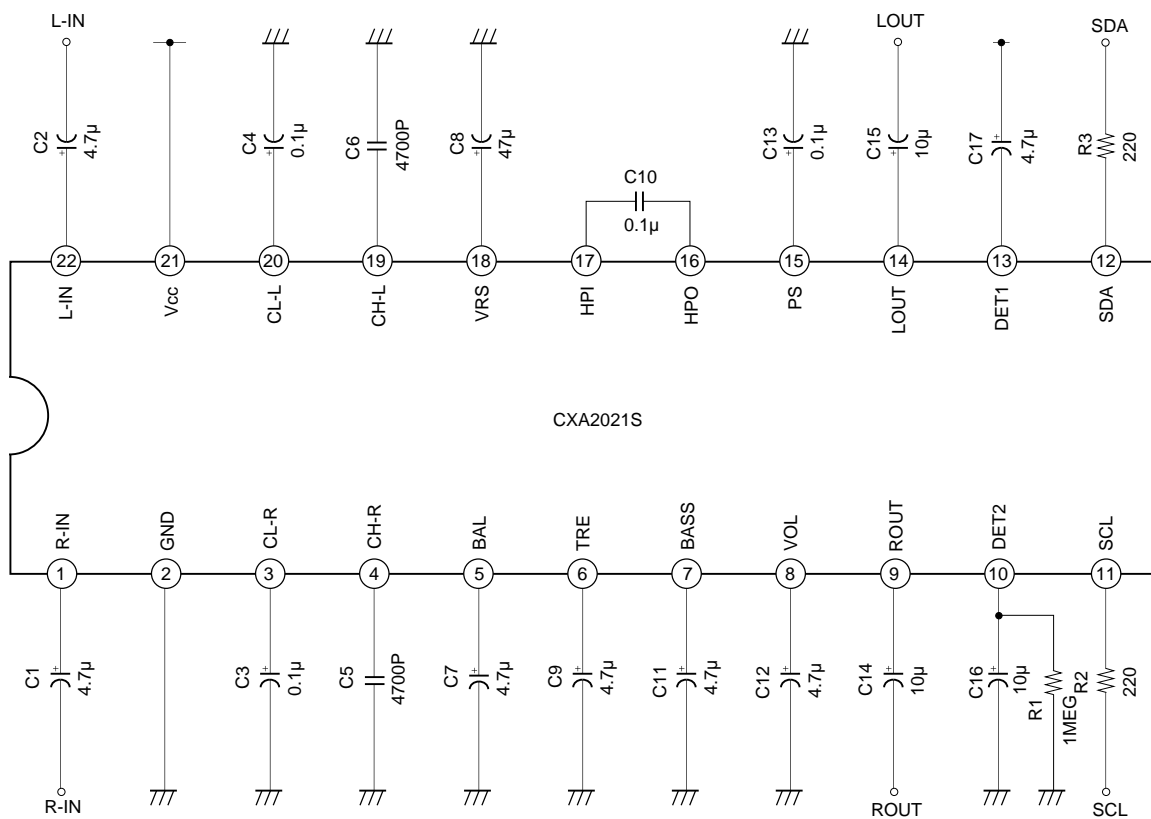

Application circuits shown are typical examples illustrating the operation of the devices. Sony cannot assume responsibility for any problems arising out of the use of these circuits or for any infringement of third party patent and other right due to same.

(Ta = 25°C, Vcc = 12V)

Electrical Characteristics

No.	Measurement item	Symbol	Input conditions							Input point	Input signal	SW set to ON	Measure-ment point	Remarks	Min.	Typ.	Max.	Unit
			VOL	MUTE	AGC	BASS	MODE	TRE	BAL									
1	Current consumption	Icc	3F	0	0	10	0	10	20					16	31	50	mA	
2	FLAT L, R	VFL,R	→							L-IN R-IN	1kHz 2.4Vrms		LOUT ROUT	REF: INPUT	-2.0	0	2.0	dB
3	REF, Level L, R	VRL,R	20								→			-17	-14	-11	dB	
4	VOL MIN L, R	VMINL,R	0								→			—	—	-70	dB	
5	FLAT frequency response 100Hz	VFL L,R	20								100Hz 2.4Vrms			REF: VR L,R	-1.5	0	1.5	dB
6	FLAT frequency response 10kHz	VHFL,R				→					10kHz 2.4Vrms				-1.5	0	1.5	dB
7	BASS BOOST 100Hz	VBST LF			1F				1F		100Hz 2.4Vrms				8.5	11	13.5	dB
8	TREBLE BOOST 10kHz	VBST HF			→				→		10kHz 2.4Vrms				8.5	11	13.5	dB
9	BASS CUT 100Hz	VCUT LF			0				0		100Hz 2.4Vrms				-13.5	-11	-8.5	dB
10	TREBLE CUT 10kHz	VCUT HF			→				→		10kHz 2.4Vrms				-13.5	-11	-8.5	dB
11	BALANCE BOOST L	VBAL BSTL				10			10	3F	1kHz 2.4Vrms		LOUT		0	1.2	2.0	dB
12	BALANCE CUT L	VBAL CUT L								0			→		—	—	-30	dB
13	BALANCE BOOST R	VBAL BST R								→			ROUT		0	1.2	2.0	dB
14	BALANCE CUT R	VBAL CUT R	→							3F			→		—	—	-30	dB

No.	Measurement item	Symbol	Input conditions							Input point	Input signal	SW set to ON	Measure-ment point	Remarks	Min.	Typ.	Max.	Unit
			VOL	MUTE	AGC	BASS	MODE	TRE	BAL									
15	Distortion L, R	V _{dist}	3F	0	0	10	0	10	0	10	20	L-IN R-IN	1kHz 2.4Vrms				2.0	%
16	Mute L, R	V _{MT L, R}		1										REF: INPUT			-70	dB
17	Cross-Talk L → R	V _{CT L, R}		0								L-IN		REF: V _{FR}			-70	dB
18	Cross-Talk R → L	V _{CTR, L}										R-IN		REF: V _{FL}			-70	dB
19	NOISE LEVEL L, R	V _{NOIL, R}												30kHz LPF			-60	dBm
20	AGC BOOST L, R	V _{GCB L, R}			0 ↓ 1							L-IN R-IN	1kHz 10mVrms	REF: AGC-OFF (0)	0	2.5	5	dB
21	AGC BOOST2 L, R	V _{GCB2 L, R}			0 ↓ 1								1kHz 50mVrms	REF: AGC-OFF (0)	5	7	10	dB
22	AGC NULL L, R	V _{GCN L, R}			0 ↓ 1								1kHz 160mVrms	REF: AGC-OFF (0)	-2.5	-0.5	2	dB
23	AGC CUT L, R	V _{GCC L, R}			0 ↓ 1								1kHz 2Vrms	REF: AGC-OFF (0)	-24	-20	-16	dB
24	SS DIF GAIN L	S _{DG L}			0			1				L-IN	1kHz 2.5Vrms		-2	0	2	dB
25	SS DIF GAIN R	S _{DG R}										R-IN			-2	0	2	dB
26	SS MIX LEVEL L	S _{MX L}										PS	1kHz 1.25Vrms		3	6	9	dB
27	SS MIX LEVEL R	S _{MX R}													3	6	9	dB
28	DC OFF-Set 1	DO1				10 ↓ 0			0						-1	0	1	V

No.	Measurement item	Symbol	Input conditions								Input point	Input signal	SW set to ON	Measure-ment point	Remarks	Min.	Typ.	Max.	Unit
			VOL	MUTE	AGC	BASS	MODE	TRE	BAL										
29	DC OFF-Set 2	DO2	3F	0	0	10 ↓ 1F	0	10	20							-1	0	1	V
30	DC OFF-Set 3	DO3				10		10 ↓ 0								-1	0	1	V
31	DC OFF-Set 4	DO4						10 ↓ 1F								-1	0	1	V
32	DC OFF-Set OFF → SS	DO _{SS} L, R						0 ↓ 1		10						-150	0	150	mV
33	VOL MIN NOISE L, R	V _{MIN} NO L, R	0					0								-	-92	-85	dBm

<Description of Operations>**• AGC circuit**

The AGC circuit is incorporated in the input block. When AGC is turned ON, gain is 0dB for small signal input, boosted for medium signal input and reduced for large signal input. The AGC circuit can absorb volume differences between input sources.

• Surround circuit

L-R signals passing through the phase shifter are added to L channel and R channel each in the opposite phase. The transfer function of the phase shifter is obtained by the following equation:

$$V_o = \frac{1 - SCR}{1 + SCR} V_{in}$$

where R is internal resistance $\approx 18k\Omega$ and C is external capacitance.

• TONE circuit

BASS and TREBLE tone control. BASS control characteristic can be determined by external capacitance connected to C_L, and TREBLE control characteristic by external capacitance connected to C_H. Tone control can be performed in 32 steps.

• BALANCE and VOLUME circuits

Controls BALANCE and VOLUME in 64 steps each.

• DAC

DAC circuit for controlling BASS, TREBLE, VOLUME and BALANCE. Internal impedance is approximately 20k Ω . Connect external capacitance for LPF.

TONE characteristic

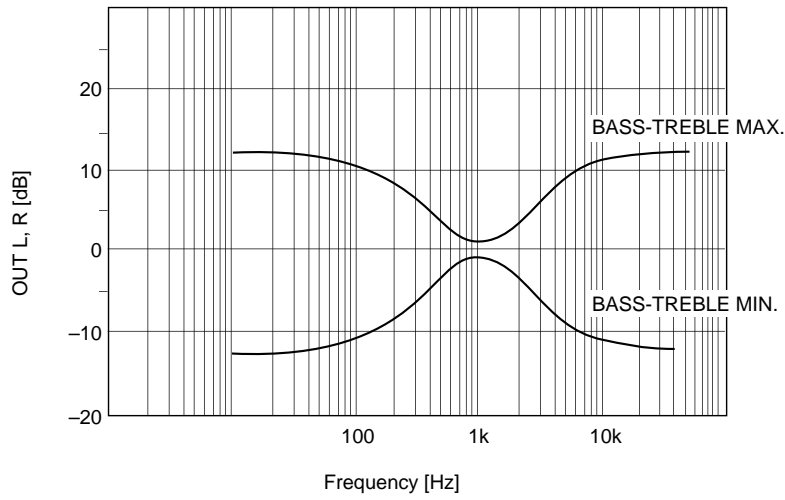

CH. vs. TREBLE-CONTROL (MAX)

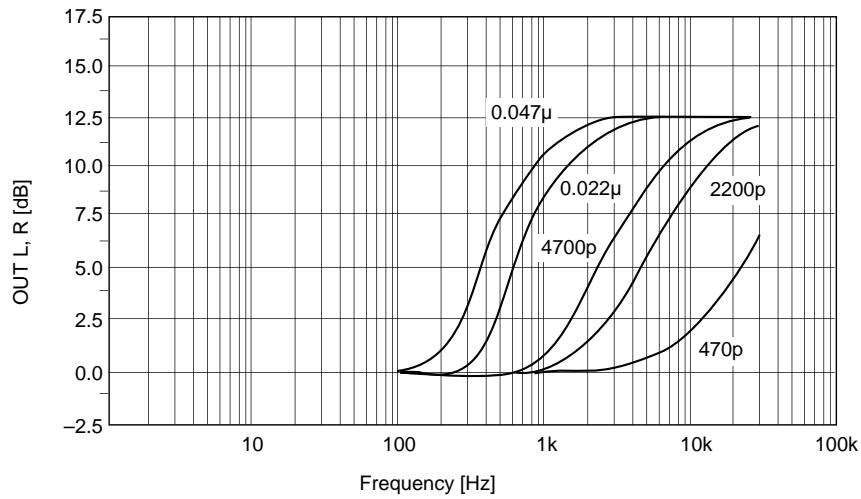

CL. vs. BASS-CONTROL (MAX)

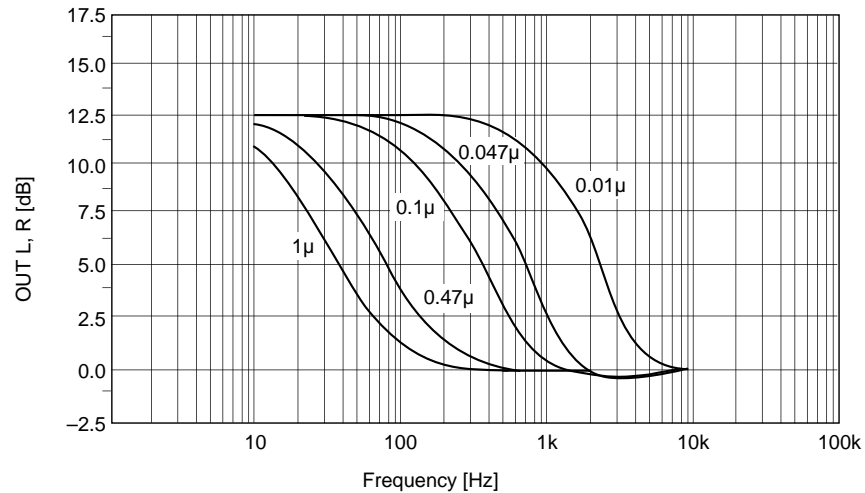

VOL CONTROL characteristic

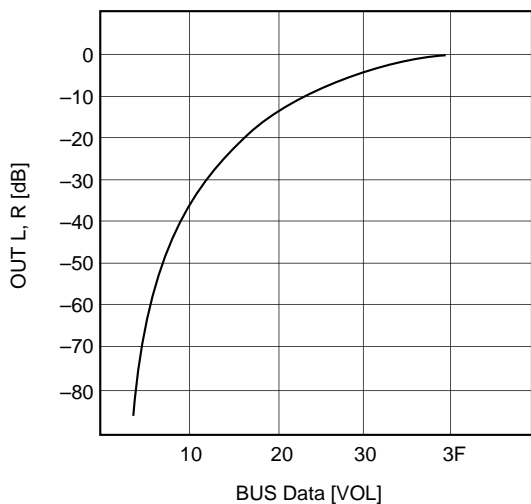

BALANCE CONTROL characteristic

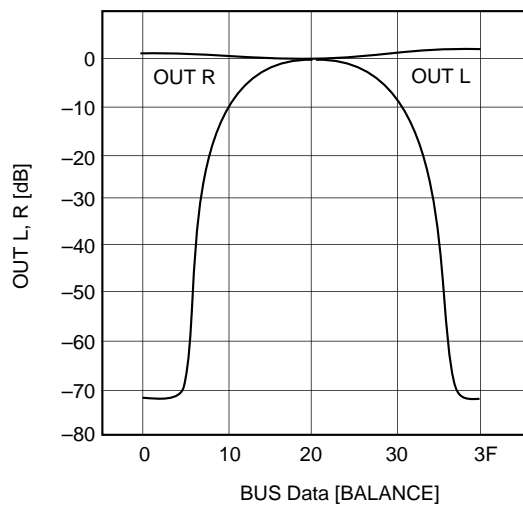

BASS CONTROL characteristic

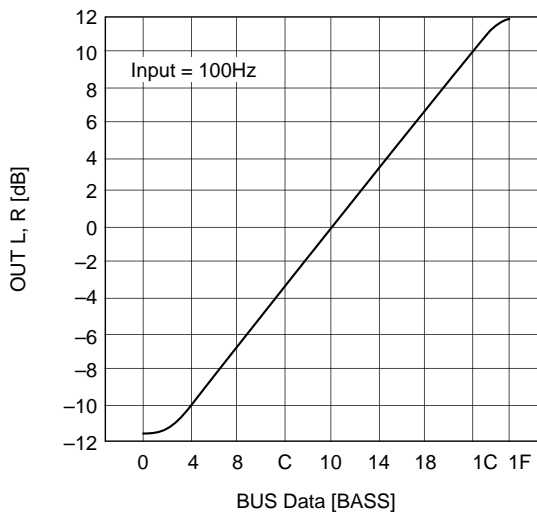

TREBLE CONTROL characteristic

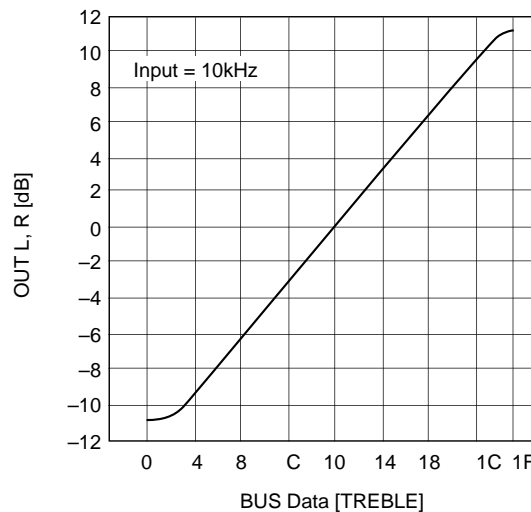

AGC characteristic

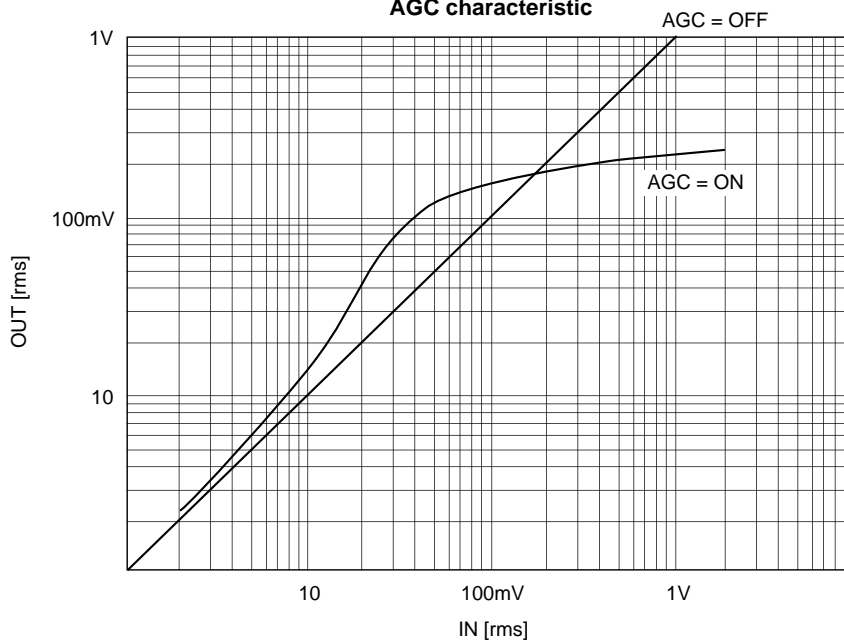

Package Outline Unit: mm

22PIN SDIP (PLASTIC)

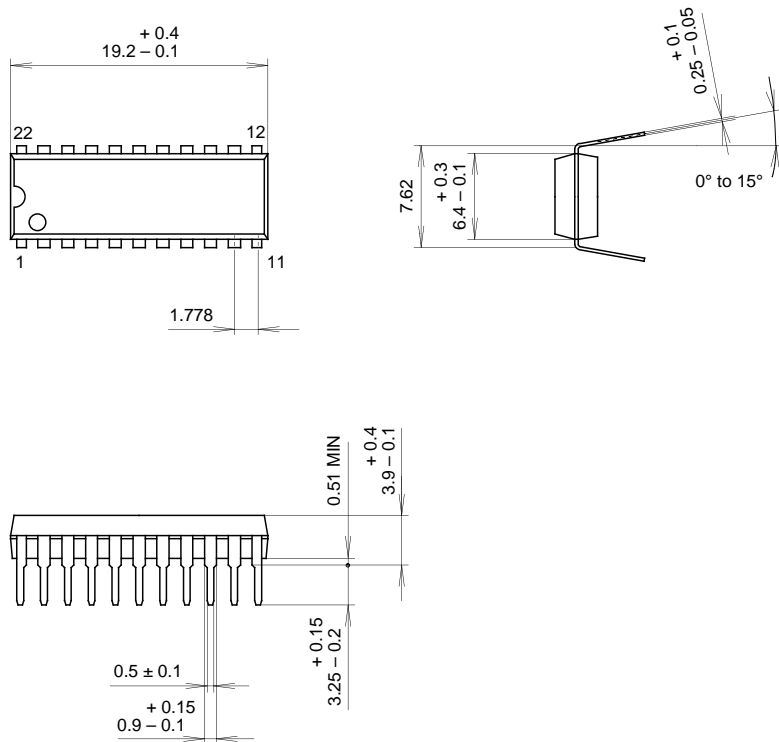

PACKAGE STRUCTURE

SONY CODE	SDIP-22P-01
EIAJ CODE	SDIP022-P-0300
JEDEC CODE	_____

MOLDING COMPOUND	EPOXY RESIN
LEAD TREATMENT	SOLDER PLATING
LEAD MATERIAL	COPPER ALLOY
PACKAGE WEIGHT	0.95g