

Low Power FM IF Amplifier

Description

The CXA1402M/N is an FM IF amplifier ideally suited for use in an FM radio like a cellular radio.

Features

- Contains an FM detector, RSSI and all other functions that follow the IF amplifier that are required for a cellular radio.
- Wide operating voltage range from 3.0V to 7.0V and low current consumption. ($I_{CC}=1.7\text{mA}$ Typ. when $V_{CC}=3.5\text{V}$)
- Built-in audio output buffer circuit reduces external parts to a minimum.
- RSSI provides wide range and superb temperature characteristics.
- Available in 16-pin SOP and SSOP packages featuring smaller size.

Functions

- IF amplifier, limiter
- RSSI (Received Signal Strength Indicator)
- FM detector circuit

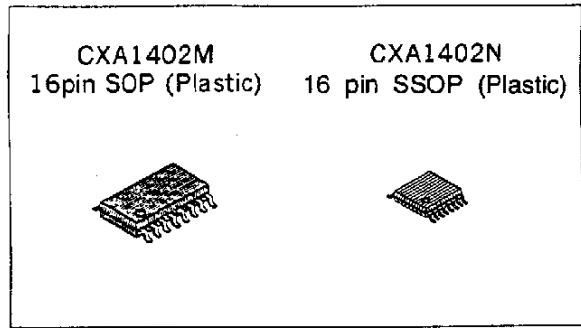

Absolute Maximum Ratings ($T_a=25^\circ\text{C}$)

• Supply voltage	V_{CC}	12	V
• Operating temperature	T_{opr}	-35 to +85	$^\circ\text{C}$
• Storage temperature	T_{stg}	-55 to +150	$^\circ\text{C}$
• Allowable power dissipation	P_D	500	mW

Operating Condition

Supply voltage	V_{CC}	3.0 to 7.0	V
----------------	----------	------------	---

Block Diagram and Pin Configuration (Top View)

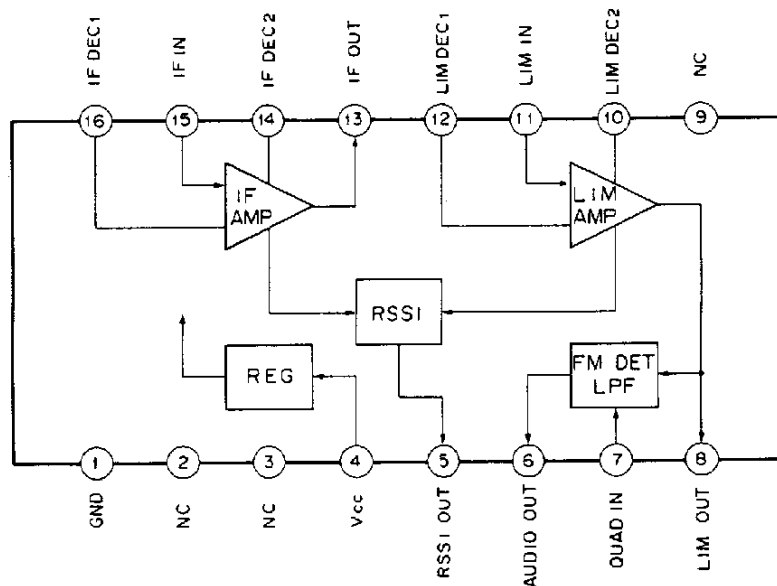

Pin Description

Pin No.	Symbol	Pin voltage	Equivalent circuit	Description
1	GND1	0V		Ground pin.
4	V _{CC}	3.6V		Power supply pin.
5	RSSI OUT	0.4V		Outputs current suitable for input signal level to IF amplifier and LIM amplifier.
6	AUDIO OUT	1.3V		Outputs FM detected signal.
7	QUAD IN	3.6V		Input pin of quadrature detector circuit. Resonance circuit connected between Pins 7 and 8 to shift phase of IF signal when IF signal is input.
8	LIM OUT	2.6V		Output pin of limiter.
10 11 12	LIM DEC2 LIM IN LIM DEC1	2.6V 2.6V 2.6V		Input and decoupling pins of limiter. Pins 10 and 12 grounded with 0.01 to 0.047μF capacitors.

Pin No.	Symbol	Pin voltage	Equivalent circuit	Description
13	IF OUT	1.3V		Output pin of IF amplifier.
14 15 16	IF DEC2 IF IN IF DEC1	2.6V 2.6V 2.6V		Input and decoupling pins of IF amplifier. Pins 14 and 16 grounded with 0.01 to 0.047 μ F capacitors.

Electrical Characteristics ($V_{CC}=3.6V$ $T_a=25^\circ C$) $0dBm=0.223V$

No.	Item	Symbol	Input signal	Remarks	Min.	Typ.	Max.	Unit
1	Current consumption	I_{CC1}			1.3	1.7	2.4	mA
2	IF amplifier voltage gain	VG1	V_{IN1} 455kHz -50dBm		44	48	52	dB
3	Limit voltage gain	VG2	V_{IN2} 455kHz -90dBm		66	72	76	dB
4	Audio output voltage	VO3	V_{IN2} 455kHz -20dBm	Modulation frequency 1kHz Deviation 8kHz	155	195	225	mVrms
5	Audio output distortion factor	VD3	V_{IN2} 455kHz -20dBm	Modulation frequency 1kHz Deviation 8kHz			1	%
6	Audio output S/N ratio	SN3	V_{IN2} 455kHz -20dBm	Modulation frequency 1kHz Deviation 8kHz	40			dB
7	Audio output AMRR	AR3	V_{IN2} 455kHz -20dBm	Modulation frequency 1kHz AM modulation 30%	30			dB
8	RSSI output voltage L	VO4L	V_{IN1} 455kHz -100dBm			0.50		V
9	RSSI output voltage H	VO4H	V_{IN1} 455kHz -20dBm			1.55		V

Notes on Operation

When using the CXA1402 M/N, pay attention to the following points, as the voltage gains of the IF amplifier and limiter amplifier are as high as approximately 48dB and 72dB respectively.

1. Decouple the power supply at a point as close to Pin 4 as possible by use of an L and C.
2. Be sure to ground Pins 2, 3 and 9 (NC).
3. Space the input and output lines as far away from each other as possible, and wire them over the shortest possible distance.
4. Ground the decoupling capacitors for the IF amplifier (Pins 14 and 16) and limiter amplifier (Pins 10 and 12) at points as close to the respective pins as possible.
5. Give due considerations to the GND pattern so that the impedance will be reduced to a minimum.
6. The input and output of the limiter amplifier can be effectively electrostatically separated by setting up a shield plate in between. (Utilize the GND of Pin 1 and the NC of Pin 9.)

Application Note

1) Power supply

The CXA1402M/N has a built-in voltage regulator and is designed to operate over a wide range of operating voltage from + 3.0 to 7.0V (Typ: 3.6V). Within the above-mentioned supply voltage range its characteristics remain almost unchanged. Decouple the power supply pin, Pin 4, by use of an L and C. (See the following illustration.)

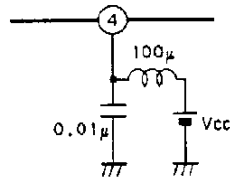

Example of Decoupling of Power Supply

2) Filter

A proper band pass filter to be connected between Pins 13 and 11 of the CXA1402M/N is one that is built to the following specifications.

- Input and output impedance: $1.5k\Omega \pm 10\%$
- Insertion loss (center frequency): $< 6dB$

The other items such as center frequency, 3dB band width, etc. vary on different requirements. Use a proper filter suitable for your specific requirements.

3) Phase shifter

For quadrature FM detection, the phase of the limiter output (Pin 8) is shifted 90° by the RLC parallel resonance circuit and discriminator as the output is input from Pin 7.

The following illustration shows the phase shifter comprising the RLC parallel resonance circuit.

In this case, the values of L and C should be determined so that the frequency of the 2nd IF signal and the parallel resonance frequency will be equal. The value of R which determines the audio output level should be selected so that a required output will be available.

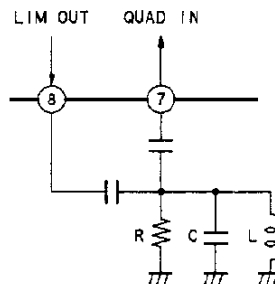

RLC Phase Shifter

4) Audio output

The FM modulated audio data is demodulated in the preceding stage and is output from Pin 6 (AUDIO OUT).

5) RSSI

The RSSI is a function for detection of the size of input signal level. In the CXA1402M/N, the output is in the form of a current which increases almost evenly within a range of IF input level from -100 to 0dBm (2.24 μ to 224m Vrms) and is almost free from the effects of the supply voltage and temperature.

The output current, however, falls within a range of $\pm 20\%$, depending on the resistance in the IC. When a voltage output is necessary, current-voltage conversion should be made by use of a resistor, etc. In this case, the resistance value depends on the maximum output current of the RSSI and the allowable maximum voltage of Pin 5. Let the maximum output current of the RSSI be approximately 380 μ A (Typ: 310 μ A) and the allowable maximum voltage (maximum performance-guaranteed voltage) be $V_{CC} - 0.5V$, and select a resistor on the basis of the supply voltage and a desired output voltage. When an output voltage of more than $V_{CC} - 0.5V$ is necessary, derive it by amplification through use of an operational amplifier, etc.

When the RSSI output voltage is required for conformance with the AMPS which is the cellular radio standard calling for a uniform increase beginning at 0V, use an offset correction circuit to let the output voltage begin at 0V, because the CXA1402M/N involves an offset of 2.0 to 0.4V ($V_{CC} = 3.6V$ $R_L = 4.7k\Omega$).

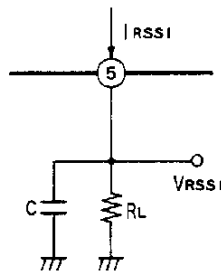

Current-Voltage Conversion of RSSI Output by Resistor

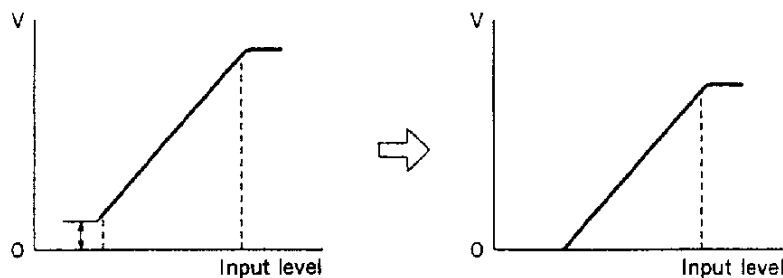

RSSI Output Voltage Offset Correction

Audio Demodulation Characteristics (IF IN/AUDIO OUT)

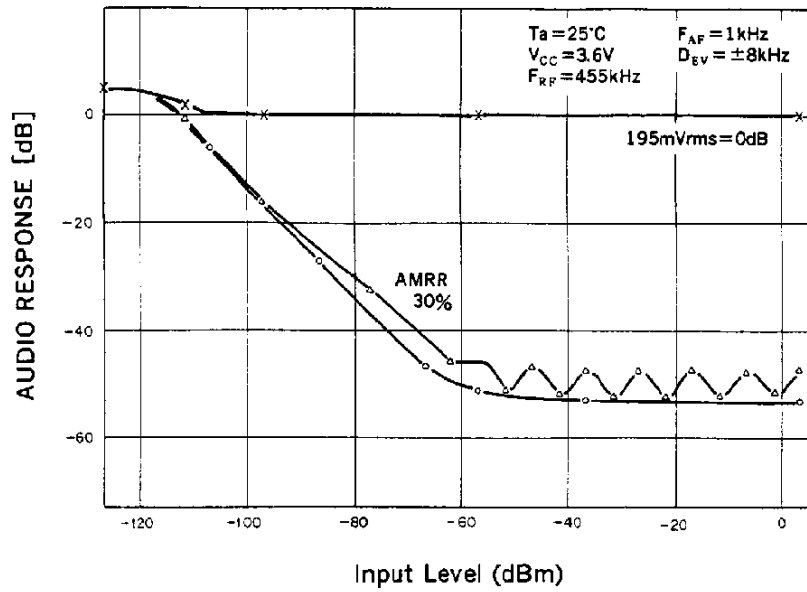

Input Level vs. RSSI Output Voltage

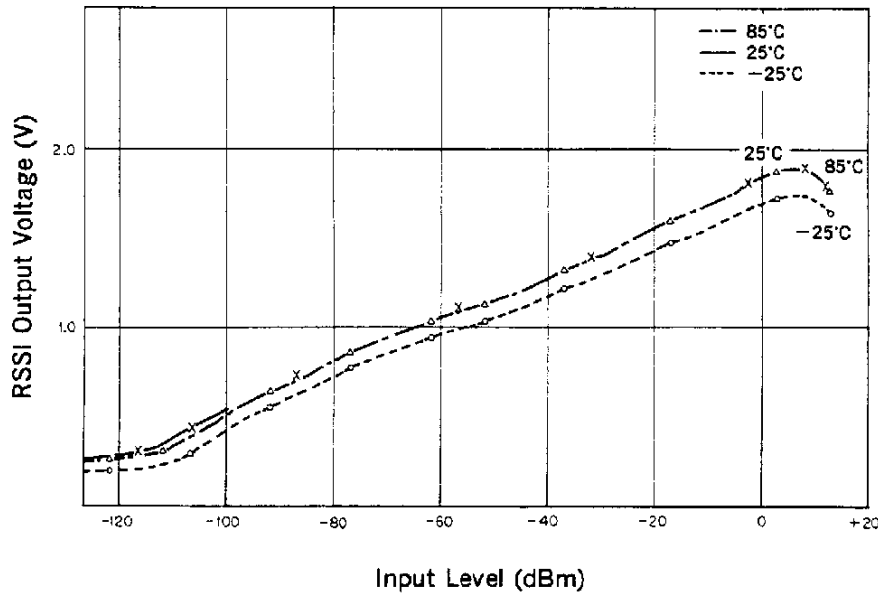

Package Outline

Unit : mm

CXA1402M

16PIN SOP (PLASTIC)

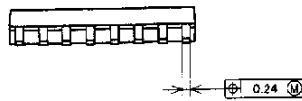
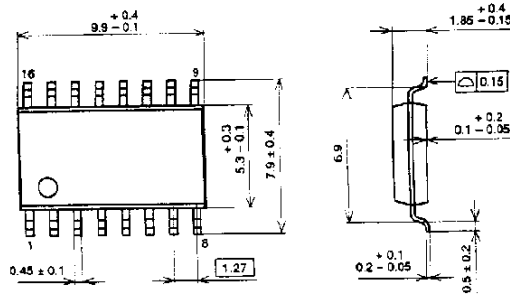

PACKAGE STRUCTURE

SONY CODE	SOP-16P-L01
EIAJ CODE	SOP016-P-0300
JEDEC CODE	

PACKAGE MATERIAL	EPOXY RESIN
LEAD TREATMENT	SOLDER PLATING
LEAD MATERIAL	COPPER ALLOY
PACKAGE MASS	0.2g

CXA1402N

16PIN SSOP (PLASTIC)

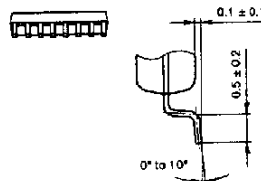
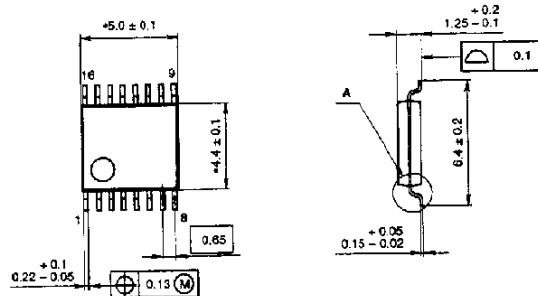

DETAIL A

NOTE: Dimension "A" does not include mold protrusion.

PACKAGE STRUCTURE

SONY CODE	SSOP-16P-L01
EIAJ CODE	SSOP016-P-0044
JEDEC CODE	

PACKAGE MATERIAL	EPOXY RESIN
LEAD TREATMENT	SOLDER / PALLADIUM PLATING
LEAD MATERIAL	42/COPPER ALLOY
PACKAGE MASS	0.1g

NOTE : PALLADIUM PLATING

This product uses S-PdPPF (Sony Spec.-Palladium Pre-Plated Lead Frame).