

# 0.5mm Pitch SMT Board to Board Connector

## DF16 Series

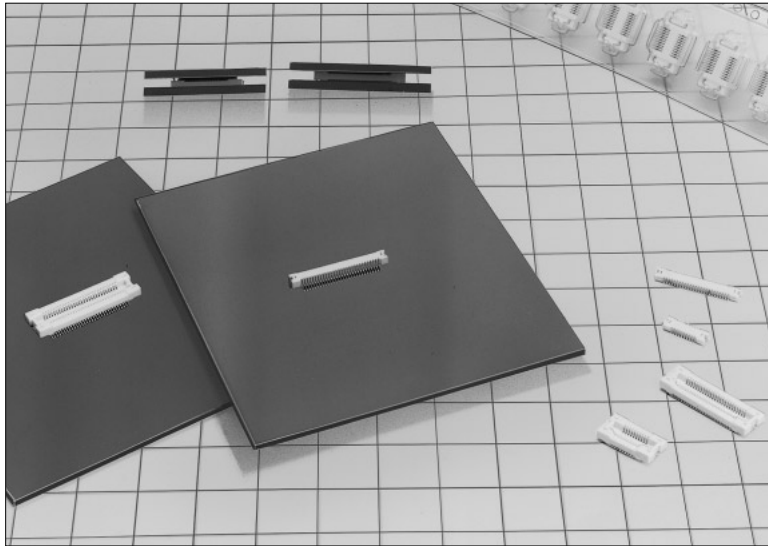

### Correspond to Automatic Mounting

The vacuum pick-up area is prepared for automatic mounting machine.

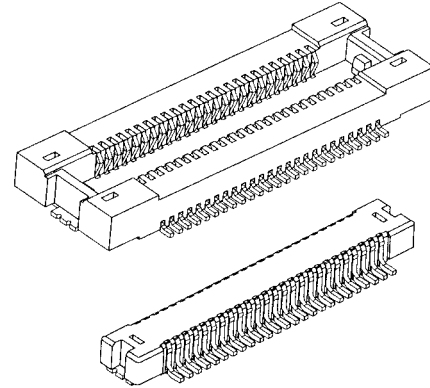

## ■ Features

### 1. Miniaturizing and Slimming

In addition to 0.5mm pitch miniaturization, board to stacking height of 2mm and 2.5mm are provided.

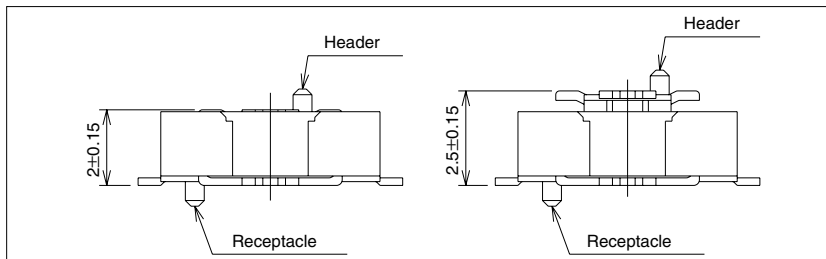

Receptacle commonly uses DF16#-\*DS-0.5V.

Header Product Name	Stacking Height
DF16#(2.0)-*DP-0.5V	2.0mm
DF16#(2.5)-*DP-0.5V	2.5mm

Note1: The stacking height doesn't include the solder paste thickness.

### 2. High Contact Reliability

The bellows female contact has a sufficient spring characteristic despite the low profile, and achieves high contact reliability.

### 3. Click Sensitivity in Mating

The click feeling is considered to facilitate insertion check when the connector is mated.

### 4. Metal Fitting Available

The metal fitting to prevent the solder peel is provided, considering the mounting on FPC.

### 5. Corresponding to Automatic Mounting

The connector has the vacuum pick-up area, and enables the automatic mounting with the embossed tape packaging. Connector specification with no boss and no fitting is also.

## ■ Applications

Mobile phone, LCD(Liquid Crystal Display), and so on

## Product Specifications

Rating	Current rating : 0.3A	Operating Temperature Range : -35 to +85°C (Note 1)	Storage Temperature Range : -10 to +60°C (Note 2)
	Voltage rating : 50V AC	Operating Humidity Range : 40 to 80%	Storage Humidity Range : 40 to 70% (Note 2)

Item	Specification	Condition
1. Insulation Resistance	500M ohms min	100V DC
2. Withstanding voltage	No flashover or insulation breakdown.	150V AC/1 minute
3. Contact Resistance	50m ohms max	100mA
4. Vibration	No electrical discontinuity of 1μs or more	Frequency: 10 to 55 Hz, single amplitude of 0.75 mm, 2 hours in each of the 3 directions.
5. Humidity (Steady state)	Contact resistance: 50m ohms max. Insulation resistance: 250M ohms min.	96 hours at temperature of 40°C and humidity of 90% to 95%
6. Temperature Cycle	Contact resistance: 50m ohms max. Insulation resistance: 500M ohms min.	(-55°C: 30 minutes 5 to 35°C: 10 minutes 85°C: 30 minutes 5 to 35°C: 10 minutes) 5 cycles
7. Durability (Mating/un-mating)	Contact resistance: 50m ohms	50cycle
8. Resistance to Soldering heat	No deformation of components affecting performance.	Reflow: At the recommended temperature profile
		Manual soldering: 300°C for 3 seconds

Note 1: Includes temperature rise caused by current flow.

Note 2: The term "storage" refers to products stored for long period of time prior to mounting and use. Operating Temperature Range and Humidity range covers non conducting condition of installed connectors in storage, shipment or during transportation.

## Material

Product	Part	Material	Treatment	UL Standard
Receptacle	Insulator	Polyamide resin	White Beige (Natural)	UL94V-0
	Contact	Phosphor copper	Gold plated	————
	Metal fitting	Brass	Tin-lead plated	————
Header	Insulator	Polyamide resin	White Beige (Natural)	UL94V-0
	Contact	Phosphor copper	Gold plated	————
	Metal fitting	Brass	Tin-lead plated	————

## Ordering Information

### Receptacle/Header

**DF16**   **#**   **(\*\*)**   **-**   **\***   **DS**   **-**   **0.5**   **V**   **(\*\*)**  
①   ②   ③   ④   ⑤   ⑥   ⑦   ⑧

<b>①</b> Series Name : DF16 <b>②</b> Type <table border="1" style="width: 100%; text-align: center;"> <thead> <tr> <th></th> <th>Fitting</th> <th>Boss</th> </tr> </thead> <tbody> <tr> <td>Blank</td> <td>○</td> <td>○</td> </tr> <tr> <td>A</td> <td>×</td> <td>○</td> </tr> <tr> <td>B</td> <td>○</td> <td>×</td> </tr> <tr> <td>C</td> <td>×</td> <td>×</td> </tr> </tbody> </table>		Fitting	Boss	Blank	○	○	A	×	○	B	○	×	C	×	×	<b>③</b> Product height Receptacle : None Header : 2.0, 2.5 <b>④</b> Number of Contacts 14, 16, 20, 30, 34, 40, 50, 60, 80 (Note1) <b>⑤</b> Connector Type DS : Double-row receptacle DP : Double-row header	<b>⑥</b> Contact Pitch : 0.5mm <b>⑦</b> Contact Type V : Straight SMT <b>⑧</b> Packaging Type (81) : Gold plating, embossed tape packaging (80) : Gold plating, tube packaging
	Fitting	Boss															
Blank	○	○															
A	×	○															
B	○	×															
C	×	×															

Note1: For the 14, 16 and 80 contacts connector, the stacking height 2.0mm product only is available.

For the 34 contacts connectors, the stacking height of 2.5mm product only is available.

## ■Receptacle [With metal fitting]

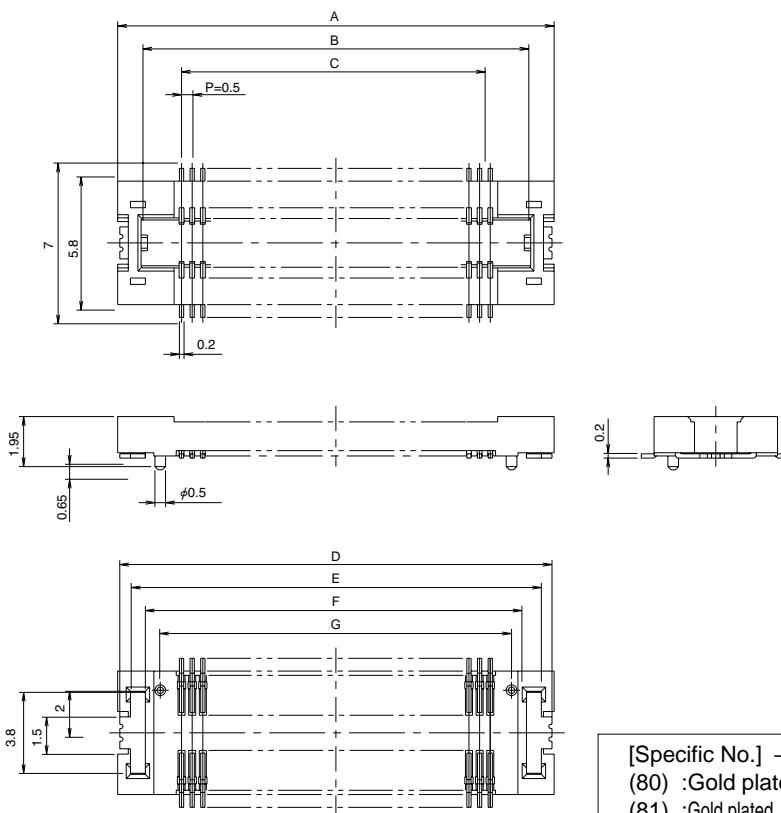

[Specific No.] -\* \*, (\* \*)  
 (80) :Gold plated, tube packaging  
 (81) :Gold plated, embossed tape packaging

### ●Receptacle with metal fitting, with boss

Unit: mm

Part Number	CL No.	Number of Contacts	A	B	C	D	E	F	G	Tube Packaging Quantity( pcs.)
DF16-14DS-0.5V(**)	679-0010-1-*	14	9.0	6.8	3.0	8.8	7.8	6.4	5.6	54 pcs.
DF16-16DS-0.5V(**)	679-0001-0-*	16	9.5	7.3	3.5	9.3	8.3	6.9	6.1	51 pcs.
DF16-20DS-0.5V(**)	679-0002-3-*	20	10.5	8.3	4.5	10.3	9.3	7.9	6.5	46 pcs.
DF16-30DS-0.5V(**)	679-0003-6-*	30	13.0	10.8	7.0	12.8	11.8	10.4	9.0	37 pcs.
DF16-34DS-0.5V(**)	679-0009-2-*	34	14.0	11.8	8.0	13.8	12.8	11.4	10.0	35 pcs.
DF16-40DS-0.5V(**)	679-0004-9-*	40	15.5	13.3	9.5	15.3	14.3	12.9	11.5	31 pcs.
DF16-50DS-0.5V(**)	679-0005-1-*	50	18.0	15.8	12.0	17.8	16.8	15.4	14.0	27 pcs.
DF16-60DS-0.5V(**)	679-0006-4-*	60	20.5	18.3	14.5	20.3	19.3	17.9	16.5	23 pcs.
DF16-80DS-0.5V(**)	679-0008-0-*	80	25.5	23.3	19.5	25.3	24.3	22.9	21.5	19 pcs.

### ●Receptacle with metal fitting, without boss

Unit: mm

Part Number	CL No.	Number of Contacts	A	B	C	D	E	F	G	Tube Packaging Quantity( pcs.)
DF16B-14DS-0.5V(**)	679-0030-9-*	14	9.0	6.8	3.0	8.8	7.8	6.4	—	54 pcs.
DF16B-16DS-0.5V(**)	679-0021-8-*	16	9.5	7.3	3.5	9.3	8.3	6.9	—	51 pcs.
DF16B-20DS-0.5V(**)	679-0022-0-*	20	10.5	8.3	4.5	10.3	9.3	7.9	—	46 pcs.
DF16B-30DS-0.5V(**)	679-0023-3-*	30	13.0	10.8	7.0	12.8	11.8	10.4	—	37 pcs.
DF16B-34DS-0.5V(**)	679-0029-0-*	34	14.0	11.8	8.0	13.8	12.8	11.4	—	35 pcs.
DF16B-40DS-0.5V(**)	679-0024-6-*	40	15.5	13.3	9.5	15.3	14.3	12.9	—	31 pcs.
DF16B-50DS-0.5V(**)	679-0025-9-*	50	18.0	15.8	12.0	17.8	16.8	15.4	—	27 pcs.
DF16B-60DS-0.5V(**)	679-0026-1-*	60	20.5	18.3	14.5	20.3	19.3	17.9	—	23 pcs.
DF16B-80DS-0.5V(**)	679-0028-7-*	80	25.5	23.3	19.5	25.3	24.3	22.9	—	19 pcs.

## ■Receptacle Without metal fitting

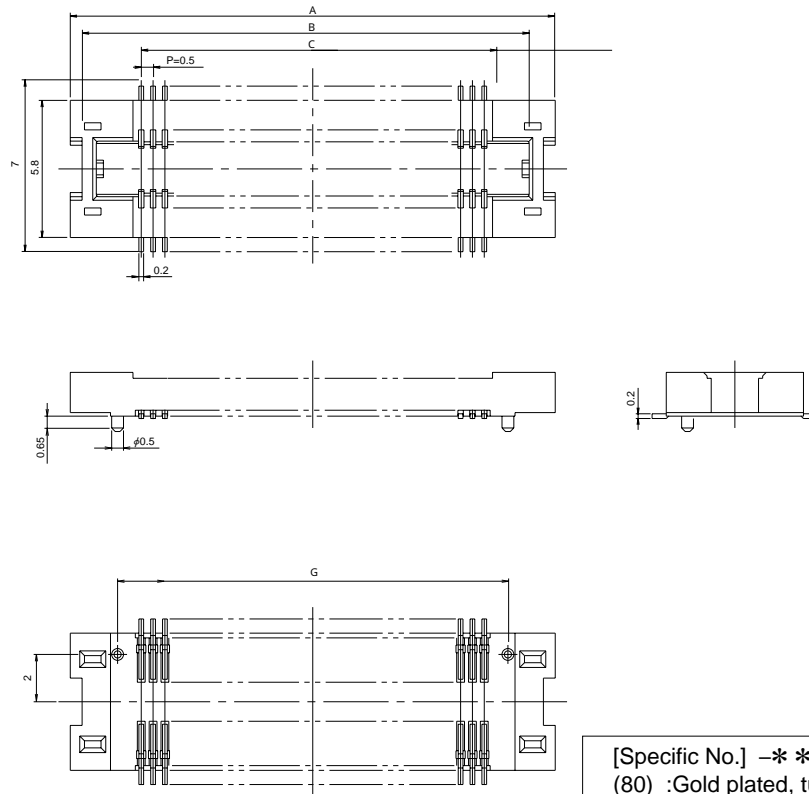
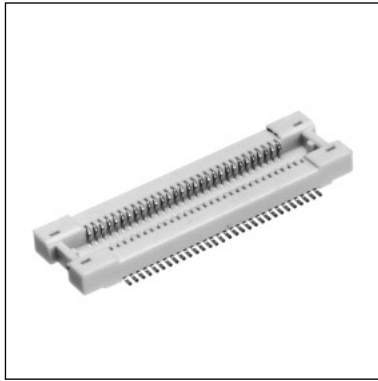

[Specific No.] -\* \*, (\* \*)  
 (80) :Gold plated, tube packaging  
 (81) :Gold plated, embossed tape packaging

### ●Receptacle without metal fitting, with boss

Unit: mm

Part Number	CL No.	Number of Contacts	A	B	C	G	Tube Packaging Quantity ( pcs.)
DF16A-14DS-0.5V(**)	679-0020-5-*	14	9.0	6.8	3.0	5.6	54 pcs.
DF16A-16DS-0.5V(**)	679-0011-4-*	16	9.5	7.3	3.5	6.1	51 pcs.
DF16A-20DS-0.5V(**)	679-0012-7-*	20	10.5	8.3	4.5	6.5	46 pcs.
DF16A-30DS-0.5V(**)	679-0013-0-*	30	13.0	10.8	7.0	9.0	37 pcs.
DF16A-34DS-0.5V(**)	679-0019-6-*	34	14.0	11.8	8.0	10.0	35 pcs.
DF16A-40DS-0.5V(**)	679-0014-2-*	40	15.5	13.3	9.5	11.5	31 pcs.
DF16A-50DS-0.5V(**)	679-0015-5-*	50	18.0	15.8	12.0	14.0	27 pcs.
DF16A-60DS-0.5V(**)	679-0016-8-*	60	20.5	18.3	14.5	16.5	23 pcs.
DF16A-80DS-0.5V(**)	679-0018-3-*	80	25.5	23.3	19.5	21.5	19 pcs.

### ●Receptacle without metal fitting, without boss

Unit: mm

Part Number	CL No.	Number of Contacts	A	B	C	G	Tube Packaging Quantity ( pcs.)
DF16C-14DS-0.5V(**)	679-0040-2-*	14	9.0	6.8	3.0	—	54 pcs.
DF16C-16DS-0.5V(**)	679-0031-1-*	16	9.5	7.3	3.5	—	51 pcs.
DF16C-20DS-0.5V(**)	679-0032-4-*	20	10.5	8.3	4.5	—	46 pcs.
DF16C-30DS-0.5V(**)	679-0033-7-*	30	13.0	10.8	7.0	—	37 pcs.
DF16C-34DS-0.5V(**)	679-0039-3-*	34	14.0	11.8	8.0	—	35 pcs.
DF16C-40DS-0.5V(**)	679-0034-0-*	40	15.5	13.3	9.5	—	31 pcs.
DF16C-50DS-0.5V(**)	679-0035-2-*	50	18.0	15.8	12.0	—	27 pcs.
DF16C-60DS-0.5V(**)	679-0036-5-*	60	20.5	18.3	14.5	—	23 pcs.
DF16C-80DS-0.5V(**)	679-0038-0-*	80	25.5	23.3	19.5	—	19 pcs.

## ■Board to Board 2mm Header [With metal fitting]

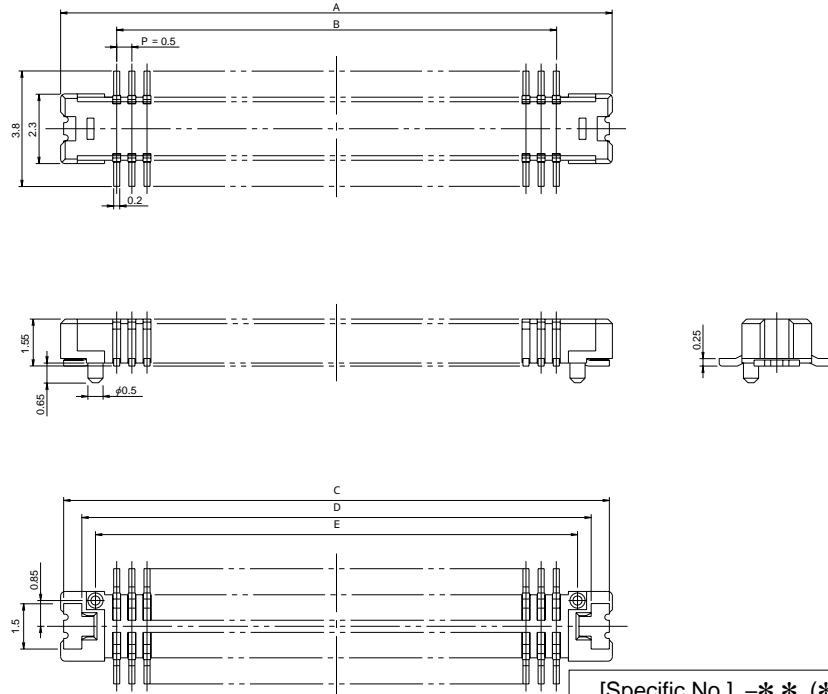
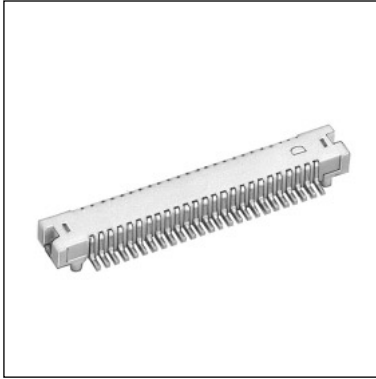

[Specific No.] -\* \*, (\* \*)  
 (80) :Gold plated, tube packaging  
 (81) :Gold plated, embossed tape packaging

### ●Board to Board 2mm Header with metal fitting, with boss

Unit: mm

Part Number	CL No.	Number of Contacts	A	B	C	D	E	Tube Packaging Quantity( pcs.)
DF16(2.0)-14DP-0.5V(**)	679-0049-7-***	14	6.7	3.0	6.5	5.3	4.4	73 pcs.
DF16(2.0)-16DP-0.5V(**)	679-0041-5-***	16	7.2	3.5	7.0	5.8	4.9	68 pcs.
DF16(2.0)-20DP-0.5V(**)	679-0042-8-***	20	8.2	4.5	8.0	6.8	5.9	59 pcs.
DF16(2.0)-30DP-0.5V(**)	679-0043-0-***	30	10.7	7.0	10.5	9.3	8.4	45 pcs.
DF16(2.0)-40DP-0.5V(**)	679-0044-3-***	40	13.2	9.5	13.0	11.8	10.9	37 pcs.
DF16(2.0)-50DP-0.5V(**)	679-0045-6-***	50	15.7	12.0	15.5	14.3	13.4	31 pcs.
DF16(2.0)-60DP-0.5V(**)	679-0046-9-***	60	18.2	14.5	18.0	16.8	15.9	26 pcs.
DF16(2.0)-80DP-0.5V(**)	679-0048-4-***	80	23.2	19.5	23.0	21.8	20.9	21 pcs.

### ●Board to Board 2mm Header with metal fitting, without boss

Unit: mm

Part Number	CL No.	Number of Contacts	A	B	C	D	E	Tube Packaging Quantity( pcs.)
DF16B(2.0)-14DP-0.5V(**)	679-0069-4-***	14	6.7	3.0	6.5	5.3	—	73 pcs.
DF16B(2.0)-16DP-0.5V(**)	679-0061-2-***	16	7.2	3.5	7.0	5.8	—	68 pcs.
DF16B(2.0)-20DP-0.5V(**)	679-0062-5-***	20	8.2	4.5	8.0	6.8	—	59 pcs.
DF16B(2.0)-30DP-0.5V(**)	679-0063-8-***	30	10.7	7.0	10.5	9.3	—	45 pcs.
DF16B(2.0)-40DP-0.5V(**)	679-0064-0-***	40	13.2	9.5	13.0	11.8	—	37 pcs.
DF16B(2.0)-50DP-0.5V(**)	679-0065-3-***	50	15.7	12.0	15.5	14.3	—	31 pcs.
DF16B(2.0)-60DP-0.5V(**)	679-0066-6-***	60	18.2	14.5	18.0	16.8	—	26 pcs.
DF16B(2.0)-80DP-0.5V(**)	679-0068-1-***	80	23.2	19.5	23.0	21.8	—	21 pcs.

## Board to Board 2mm Header Without metal fitting

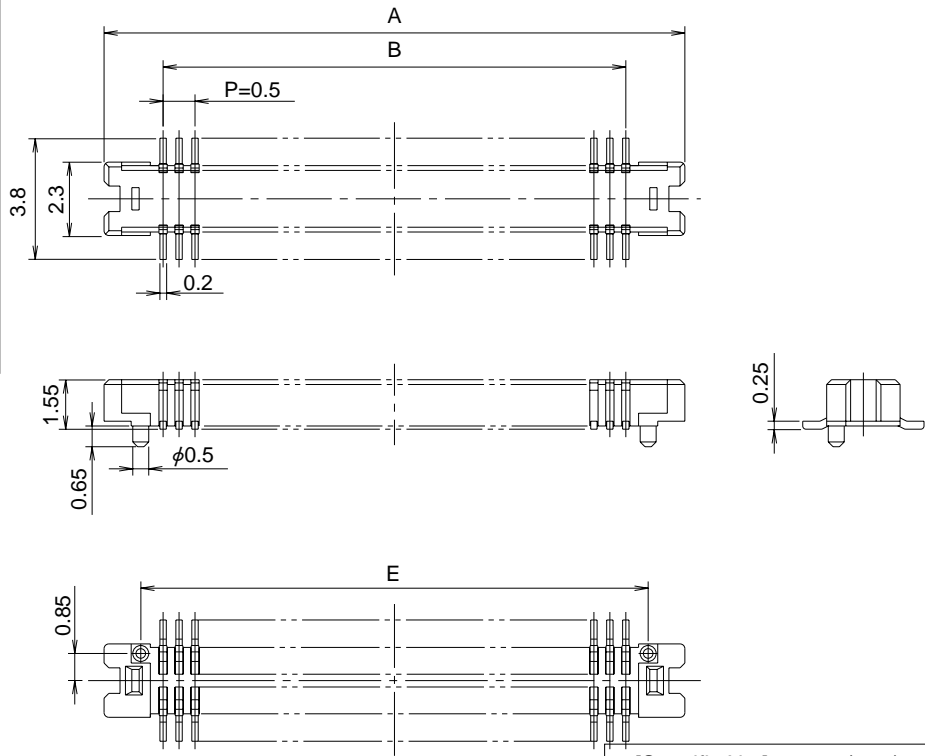
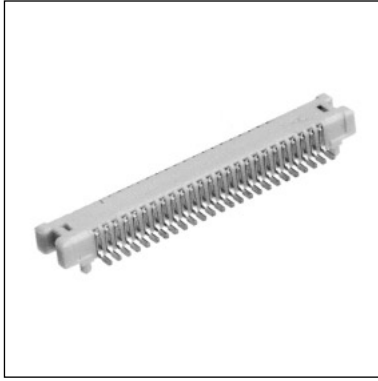

[Specific No.] -\* \*, (\* \*)  
 (80) :Gold plated, tube packaging  
 (81) :Gold plated, embossed tape packaging

### Board to Board 2mm Header without metal fitting, with boss

Unit: mm

Part Number	CL No.	Number of Contacts	A	B	E	Tube Packaging Quantity ( pcs. )
DF16A(2.0)-14DP-0.5V(**)	679-0059-0-***	14	6.7	3.0	4.4	73 pcs.
DF16A(2.0)-16DP-0.5V(**)	679-0051-9-***	16	7.2	3.5	4.9	68 pcs.
DF16A(2.0)-20DP-0.5V(**)	679-0052-1-***	20	8.2	4.5	5.9	59 pcs.
DF16A(2.0)-30DP-0.5V(**)	679-0053-4-***	30	10.7	7.0	8.4	45 pcs.
DF16A(2.0)-40DP-0.5V(**)	679-0054-7-***	40	13.2	9.5	10.9	37 pcs.
DF16A(2.0)-50DP-0.5V(**)	679-0055-0-***	50	15.7	12.0	13.4	31 pcs.
DF16A(2.0)-60DP-0.5V(**)	679-0056-2-***	60	18.2	14.5	15.9	26 pcs.
DF16A(2.0)-80DP-0.5V(**)	679-0058-8-***	80	23.2	19.5	20.9	21 pcs.

### Board to Board 2mm Header without metal fitting, without boss

Unit: mm

Part Number	CL No.	Number of Contacts	A	B	E	Tube Packaging Quantity ( pcs. )
DF16C(2.0)-14DP-0.5V(**)	679-0079-8-***	14	6.7	3.0	—	73 pcs.
DF16C(2.0)-16DP-0.5V(**)	679-0071-6-***	16	7.2	3.5	—	68 pcs.
DF16C(2.0)-20DP-0.5V(**)	679-0072-9-***	20	8.2	4.5	—	59 pcs.
DF16C(2.0)-30DP-0.5V(**)	679-0073-1-***	30	10.7	7.0	—	45 pcs.
DF16C(2.0)-40DP-0.5V(**)	679-0074-4-***	40	13.2	9.5	—	37 pcs.
DF16C(2.0)-50DP-0.5V(**)	679-0075-7-***	50	15.7	12.0	—	31 pcs.
DF16C(2.0)-60DP-0.5V(**)	679-0076-0-***	60	18.2	14.5	—	26 pcs.
DF16C(2.0)-80DP-0.5V(**)	679-0078-5-***	80	23.2	19.5	—	21 pcs.

## Board to Board 2.5mm Header With metal fitting

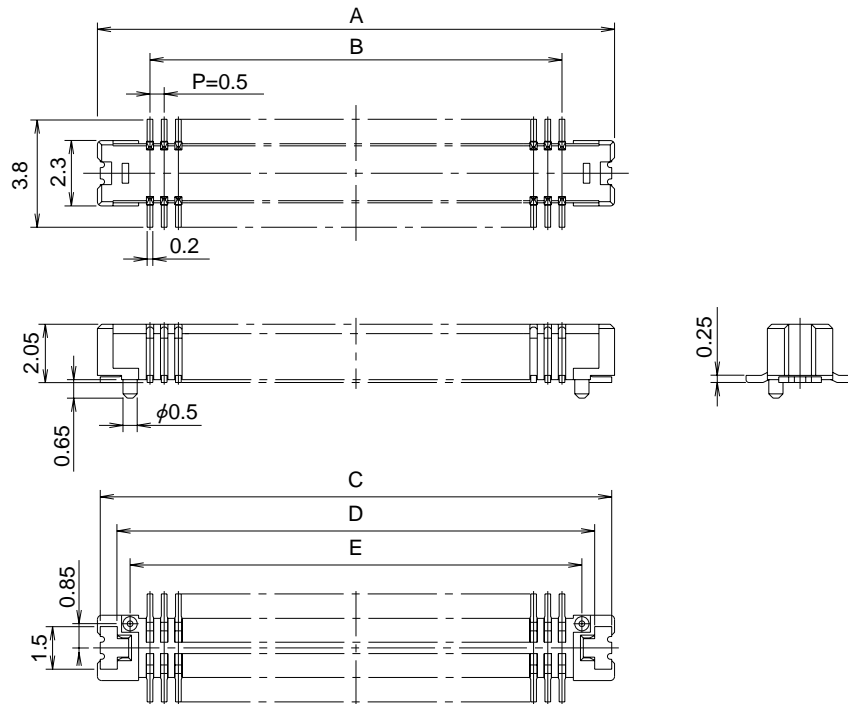
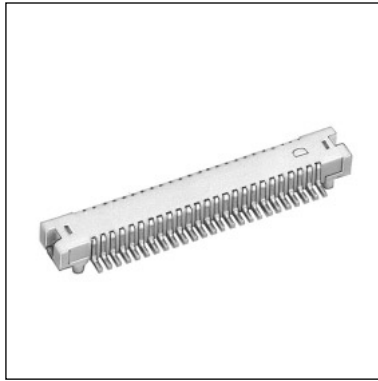

[Specific No.] -\*\* , (\*\* \*)  
 (80) :Gold plated, tube packaging  
 (81) :Gold plated, embossed tape packaging

### Board to Board 2.5mm Header with metal fitting, with boss

Unit: mm

Part Number	CL No.	Number of Contacts	A	B	C	D	E	Tube Packaging Quantity( pcs.)
DF16(2.5)-20DP-0.5V(**)	679-0082-2-**	20	8.2	4.5	8.0	6.8	5.9	59 pcs.
DF16(2.5)-30DP-0.5V(**)	679-0083-5-**	30	10.7	7.0	10.5	9.3	8.4	45 pcs.
DF16(2.5)-34DP-0.5V(**)	679-0089-1-**	34	11.7	8.0	11.5	10.3	9.4	42 pcs.
DF16(2.5)-40DP-0.5V(**)	679-0084-8-**	40	13.2	9.5	13.0	11.8	10.9	37 pcs.
DF16(2.5)-50DP-0.5V(**)	679-0085-0-**	50	15.7	12.0	15.5	14.3	13.4	31 pcs.
DF16(2.5)-60DP-0.5V(**)	679-0086-3-**	60	18.2	14.5	18.0	16.8	15.9	26 pcs.

### Board to Board 2.5mm Header with metal fitting, without boss

Unit: mm

Part Number	CL No.	Number of Contacts	A	B	C	D	E	Tube Packaging Quantity( pcs.)
DF16B(2.5)-20DP-0.5V(**)	679-0102-8-**	20	8.2	4.5	8.0	6.8	—	59 pcs.
DF16B(2.5)-30DP-0.5V(**)	679-0103-0-**	30	10.7	7.0	10.5	9.3	—	45 pcs.
DF16B(2.5)-34DP-0.5V(**)	679-0109-7-**	34	11.7	8.0	11.5	10.3	—	42 pcs.
DF16B(2.5)-40DP-0.5V(**)	679-0104-3-**	40	13.2	9.5	13.0	11.8	—	37 pcs.
DF16B(2.5)-50DP-0.5V(**)	679-0105-6-**	50	15.7	12.0	15.5	14.3	—	31 pcs.
DF16B(2.5)-60DP-0.5V(**)	679-0106-9-**	60	18.2	14.5	18.0	16.8	—	26 pcs.

## Board to Board 2.5mm Header Without metal fitting

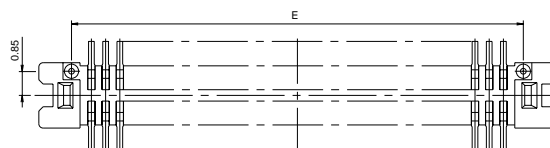
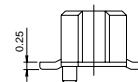
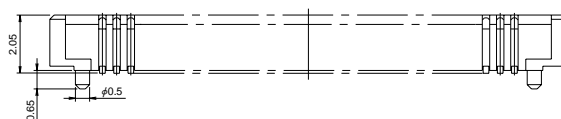
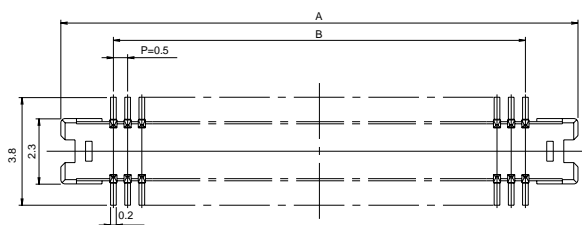

[Specific No.] -\* \*, (\* \*)  
 (80) :Gold plated, tube packaging  
 (81) :Gold plated, embossed tape packaging

### Board to Board 2.5mm Header without metal fitting, with boss

Unit: mm

Part Number	CL No.	Number of Contacts	A	B	E	Tube Packaging Quantity ( pcs.)
DF16A(2.5)-20DP-0.5V(**)	679-0092-6-***	20	8.2	4.5	5.9	59 pcs.
DF16A(2.5)-30DP-0.5V(**)	679-0093-9-***	30	10.7	7.0	8.4	45 pcs.
DF16A(2.5)-34DP-0.5V(**)	679-0099-5-***	34	11.7	8.0	9.4	42 pcs.
DF16A(2.5)-40DP-0.5V(**)	679-0094-1-***	40	13.2	9.5	10.9	37 pcs.
DF16A(2.5)-50DP-0.5V(**)	679-0095-4-***	50	15.7	12.0	13.4	31 pcs.
DF16A(2.5)-60DP-0.5V(**)	679-0096-7-***	60	18.2	14.5	15.9	26 pcs.

### Board to Board 2.5mm Header without metal fitting, without boss

Unit: mm

Part Number	CL No.	Number of Contacts	A	B	E	Tube Packaging Quantity ( pcs.)
DF16C(2.5)-20DP-0.5V(**)	679-0112-1-***	20	8.2	4.5	—	59 pcs.
DF16C(2.5)-30DP-0.5V(**)	679-0113-4-***	30	10.7	7.0	—	45 pcs.
DF16C(2.5)-34DP-0.5V(**)	679-0119-0-***	34	11.7	8.0	—	42 pcs.
DF16C(2.5)-40DP-0.5V(**)	679-0114-7-***	40	13.2	9.5	—	37 pcs.
DF16C(2.5)-50DP-0.5V(**)	679-0115-0-***	50	15.7	12.0	—	31 pcs.
DF16C(2.5)-60DP-0.5V(**)	679-0116-2-***	60	18.2	14.5	—	26 pcs.



## Recommended PCB mounting pattern

### ●Receptacle

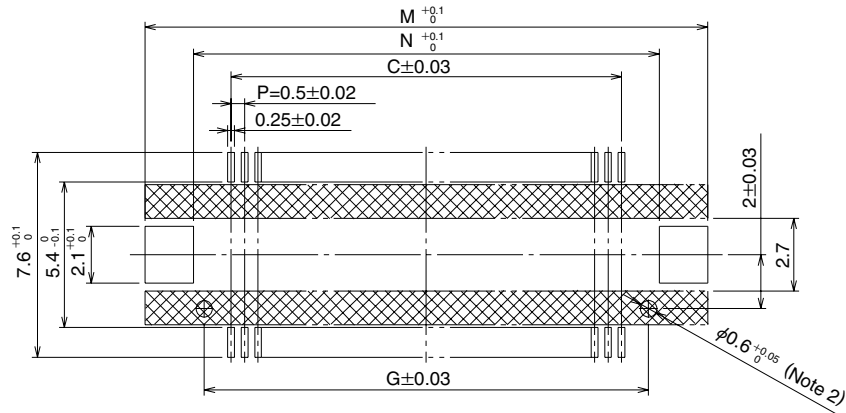

Note1: If the pattern is included in the shaded area, and is not treated with resist, it could touch the connector contact.

Note2: If the boss isn't included, the boss hole shown in the above isn't required.

Number of Contacts	C	G	M	N
14	3.0	5.0	9.4	5.8
16	3.5	5.5	9.9	6.3
20	4.5	6.5	10.9	7.3
30	7.0	9.0	13.4	9.8
34	8.0	10.0	14.4	10.8
40	9.5	11.5	15.9	12.3
50	12.0	14.0	18.4	14.8
60	14.5	16.5	20.9	17.3
80	19.5	21.5	25.9	22.3

### ●Header (Board to Board 2.0, 2.5mm)

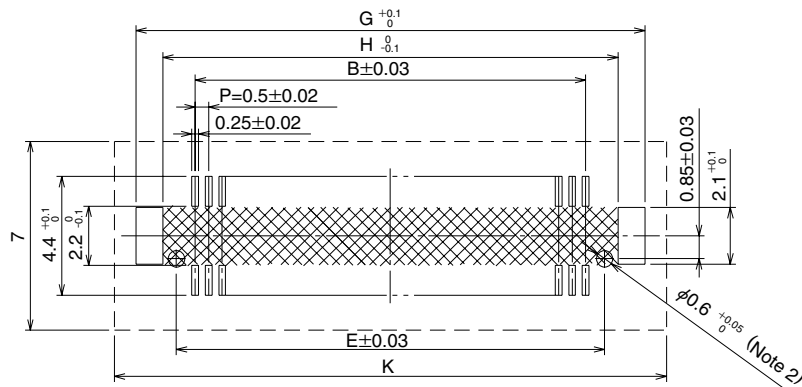

Note1: If the pattern is included in the shaded area, and is not treated with resist, it could touch the connector contact.

Note2: If the boss isn't included, the boss hole shown in the above isn't required.

Note3: Don't install any part in the shaded area. If installed, the connectors can't be mated with each other.

Number of Contacts	B	E	G	H	K
14	3.0	4.4	7.4	5.4	9.0
16	3.5	4.9	7.9	5.9	9.5
20	4.5	5.9	8.9	6.9	10.5
30	7.0	8.4	11.4	9.4	13.0
34	8.0	9.4	12.4	10.4	14.0
40	9.5	10.9	13.9	11.9	15.5
50	12.0	13.4	16.4	14.4	18.0
60	14.5	15.9	18.9	16.9	20.5
80	19.5	20.9	23.9	21.9	25.5

# Embossed Carrier Tape Dimensions

## ●Receptacle

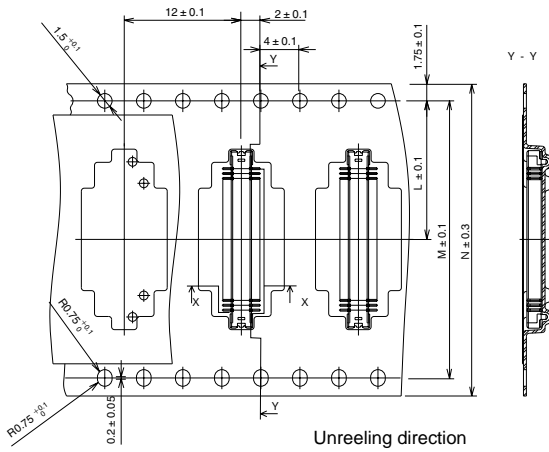

## ●Reel Dimensions

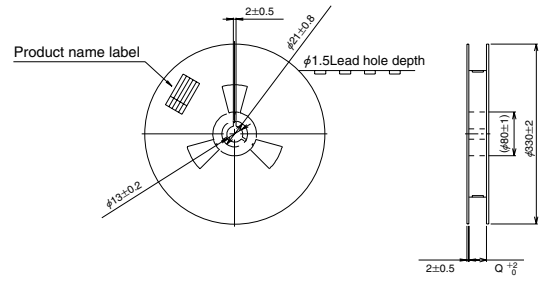

## ●Header

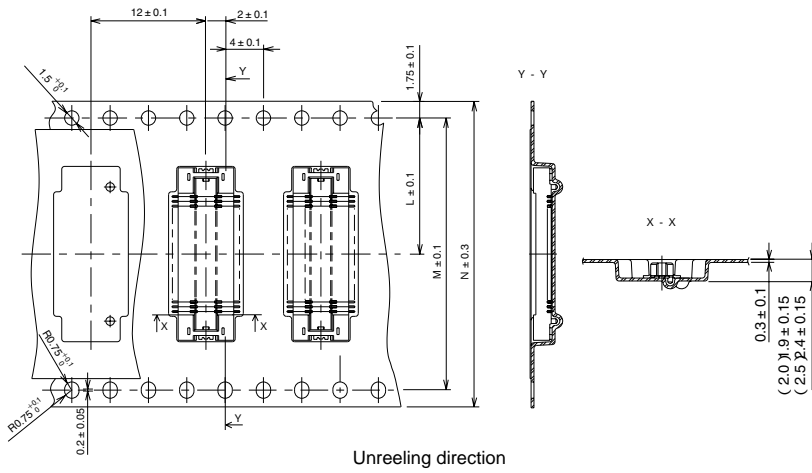

## ●Reel Dimensions

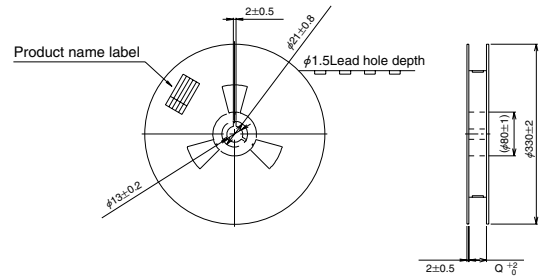

Product Name	N	M	L	Q
DF16#-14DS-0.5V	24.0	—	11.5	24.4
DF16#-16DS-0.5V	24.0	—	11.5	24.4
DF16#-20DS-0.5V	24.0	—	11.5	24.4
DF16#-30DS-0.5V	24.0	—	11.5	24.4
DF16#-34DS-0.5V	24.0	—	11.5	24.4
DF16#-40DS-0.5V	32.0	28.4	14.2	32.4
DF16#-50DS-0.5V	32.0	28.4	14.2	32.4
DF16#-60DS-0.5V	32.0	28.4	14.2	32.4
DF16#-80DS-0.5V	44.0	40.4	20.2	44.4
DF16#(2.0)-14DP-0.5V	16.0	—	7.5	16.4
DF16#(2.0)-16DP-0.5V	16.0	—	7.5	16.4
DF16#(2.0)-34DP-0.5V	24.0	—	11.5	24.4
DF16#(2.0/2.5)-20DP-0.5V	16.0	—	7.5	16.4
DF16#(2.0/2.5)-30DP-0.5V	24.0	—	11.5	24.4
DF16#(2.0/2.5)-40DP-0.5V	24.0	—	11.5	24.4
DF16#(2.0/2.5)-50DP-0.5V	24.0	—	11.5	24.4
DF16#(2.0/2.5)-60DP-0.5V	32.0	28.4	14.2	32.4
DF16#(2.0/2.5)-80DP-0.5V	44.0	40.4	20.2	44.4

## ◆ Precautions

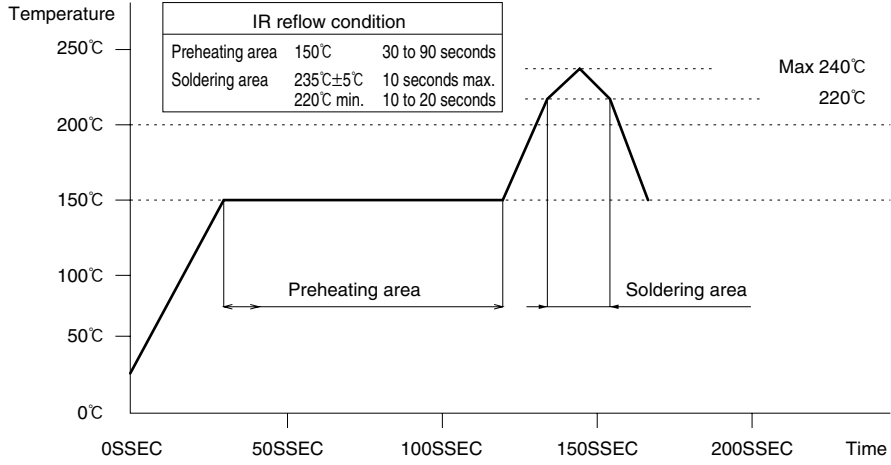
<p>1. Recommended Temperature Profile (SMT)</p>	 <table border="1" data-bbox="727 178 1063 289"> <thead> <tr> <th colspan="3">IR reflow condition</th> </tr> </thead> <tbody> <tr> <td>Preheating area</td> <td>150°C</td> <td>30 to 90 seconds</td> </tr> <tr> <td>Soldering area</td> <td>235°C±5°C 220°C min.</td> <td>10 seconds max. 10 to 20 seconds</td> </tr> </tbody> </table> <p>Note1: Maximum twice actions are allowed under the same condition. However, the interval between the first and second actions must be maintained at the room temperature.</p> <p>Note2: The temperature indicates the board surface temperature of the connector lead area.</p>	IR reflow condition			Preheating area	150°C	30 to 90 seconds	Soldering area	235°C±5°C 220°C min.	10 seconds max. 10 to 20 seconds
IR reflow condition										
Preheating area	150°C	30 to 90 seconds								
Soldering area	235°C±5°C 220°C min.	10 seconds max. 10 to 20 seconds								
<p>2. Recommended Manual Soldering Condition (SMT)</p>	<p>Soldering iron temperature: 290±10°C, Soldering time: Within 2 seconds</p>									
<p>3. Recommended Screen Thickness (SMT)</p>	<p>0.15mm</p>									
<p>4. Board Warp (SMT)</p>	<p>Maximum 0.2mm in the connector center area, based on the both connector edges</p>									
<p>5. Cleaning Condition</p>	<p>Refer to the "Nylon Connector Use Hand book".</p>									
<p>6. Cautions</p>	<ul style="list-style-type: none"> <li>■ The header is designed in a structure where contacts are exposed. Touching it with bare hands would cause contact failure or electrostatic element damage.</li> <li>■ Where no board is mounted, the insertion or extraction will cause damage or contact deformation.</li> <li>■ Avoid retaining the board with the connector only, and fix the board by any other means than the connector.</li> <li>■ Excessive scoop insertion or extraction may result in damage.</li> <li>■ In the manual soldering process, don't carry out flux coating which will cause a flux blister on the connector.</li> <li>■ The color phase of this product may be slightly different from that of the formed product according to the manufacturing lot. However, the difference doesn't affect the performance.</li> </ul>									