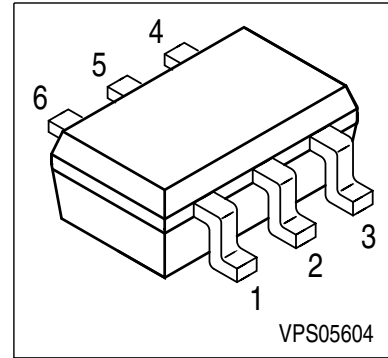
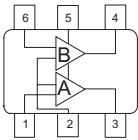
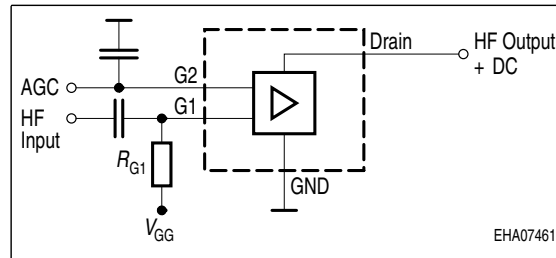
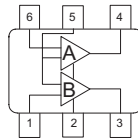

DUAL N-Channel MOSFET Tetrode

- Low noise gain controlled input stages of UHF- and VHF-tuners with 5V supply voltage
- Two AGC amplifiers in one single package
- Integrated gate protection diodes
- Low noise figure
- High gain, high forward transadmittance
- Improved cross modulation at gain reduction
- High AGC-range

BG3140

BG3140R

ESD: Electrostatic discharge sensitive device, observe handling precaution!

Type	Package	Pin Configuration						Marking
BG3140	SOT363	1=G1	2=G2	3=D	4=D	5=S	6=G1	KDs
BG3140R	SOT363	1=G1	2=S	3=D	4=D	5=G2	6=G1	KKs

180° rotated tape loading orientation available

Maximum Ratings

Parameter	Symbol	Value	Unit
Drain-source voltage	V_{DS}	8	V
Continuous drain current	I_D	25	mA
Gate 1/ gate 2-source current	$\pm I_{G1/2SM}$	1	
Gate 1/ gate 2-source voltage	$\pm V_{G1/G2S}$	6	V
Total power dissipation, $T_S \leq 78^\circ\text{C}$	P_{tot}	160	mW
Storage temperature	T_{stg}	-55 ... 150	$^\circ\text{C}$
Channel temperature	T_{ch}	150	

Thermal Resistance

Parameter	Symbol	Value	Unit
Channel - soldering point ¹⁾	R_{thchs}	≤ 280	K/W

¹⁾For calculation of R_{thJA} please refer to Application Note Thermal Resistance

Electrical Characteristics

Parameter	Symbol	Values			Unit
		min.	typ.	max.	
DC Characteristics					
Drain-source breakdown voltage $I_D = 10 \mu\text{A}$, $V_{G1S} = 0$, $V_{G2S} = 0$	$V_{(BR)DS}$	12	-	-	V
Gate1-source breakdown voltage $+I_{G1S} = 10 \text{mA}$, $V_{G2S} = 0$, $V_{DS} = 0$	$+V_{(BR)G1SS}$	6	-	15	
Gate2-source breakdown voltage $+I_{G2S} = 10 \text{mA}$, $V_{G1S} = 0$, $V_{DS} = 0$	$+V_{(BR)G2SS}$	6	-	15	
Gate1-source leakage current $V_{G1S} = 6 \text{V}$, $V_{G2S} = 0$	$+I_{G1SS}$	-	-	50	μA
Gate2-source leakage current $V_{G2S} = 8 \text{V}$, $V_{G1S} = 0$, $V_{DS} = 0$	$+I_{G2SS}$	-	-	50	nA
Drain current $V_{DS} = 5 \text{V}$, $V_{G1S} = 0$, $V_{G2S} = 4.5 \text{V}$	I_{DSS}	-	-	10	μA
Drain-source current $V_{DS} = 5 \text{V}$, $V_{G2S} = 4 \text{V}$, $R_{G1} = 70 \text{k}\Omega$	I_{DSX}	-	15	-	mA
Gate1-source pinch-off voltage $V_{DS} = 5 \text{V}$, $V_{G2S} = 4 \text{V}$, $I_D = 20 \mu\text{A}$	$V_{G1S(p)}$	-	0.7	-	V
Gate2-source pinch-off voltage $V_{DS} = 5 \text{V}$, $I_D = 20 \mu\text{A}$	$V_{G2S(p)}$	-	0.6	-	

Electrical Characteristics

Parameter	Symbol	Values			Unit
		min.	typ.	max.	
AC Characteristics - (verified by random sampling)					
Forward transconductance $V_{DS} = 5\text{ V}, V_{G2S} = 4\text{ V}$	g_{fs}	-	42	-	mS
Gate1 input capacitance $V_{DS} = 5\text{ V}, V_{G2S} = 4\text{ V}, f = 1\text{ MHz}$	C_{g1ss}	-	1.9	-	pF
Output capacitance $V_{DS} = 5\text{ V}, V_{G2S} = 4\text{ V}, f = 100\text{ MHz}$	C_{dss}	-	1.1	-	
Power gain (self biased) $V_{DS} = 5\text{ V}, I_D = 10\text{ mA}, V_{G2S} = 4\text{ V},$ $f = 800\text{ MHz}$ $V_{DS} = 5\text{ V}, I_D = 10\text{ mA}, V_{G2S} = 4\text{ V},$ $f = 45\text{ MHz}$	G_p	-	24	-	dB
		-	31	-	
Noise figure $V_{DS} = 5\text{ V}, I_D = 10\text{ mA}, V_{G2S} = 4\text{ V},$ $f = 800\text{ MHz}$ $V_{DS} = 5\text{ V}, I_D = 10\text{ mA}, V_{G2S} = 4\text{ V},$ $f = 45\text{ MHz}$	F	-	1.3	-	dB
		-	1.7	-	
Gain control range $V_{DS} = 5\text{ V}, V_{G2S} = 4...0\text{ V}, f = 800\text{ MHz}$	ΔG_p	45	-	-	
Cross-modulation $k=1\%, f_w=50\text{MHz}, f_{unw}=60\text{MHz}$ AGC = 0 dB AGC = 10 dB AGC = 40 dB	X_{mod}	96	-	-	-
		-	86	-	
		96	100	-	

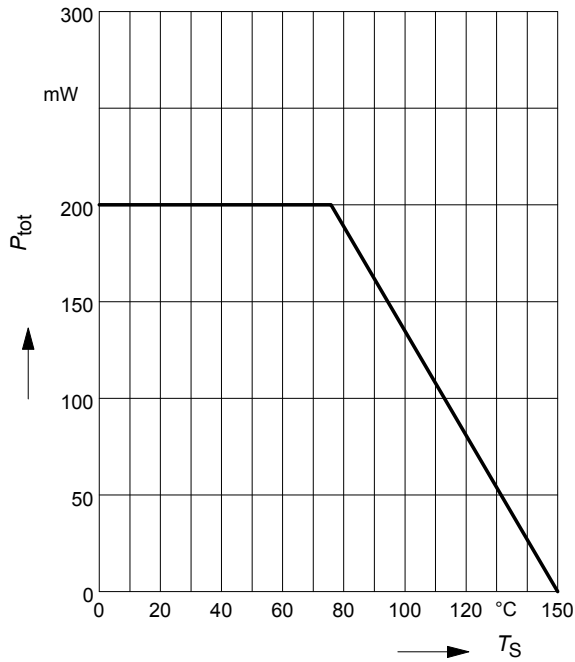
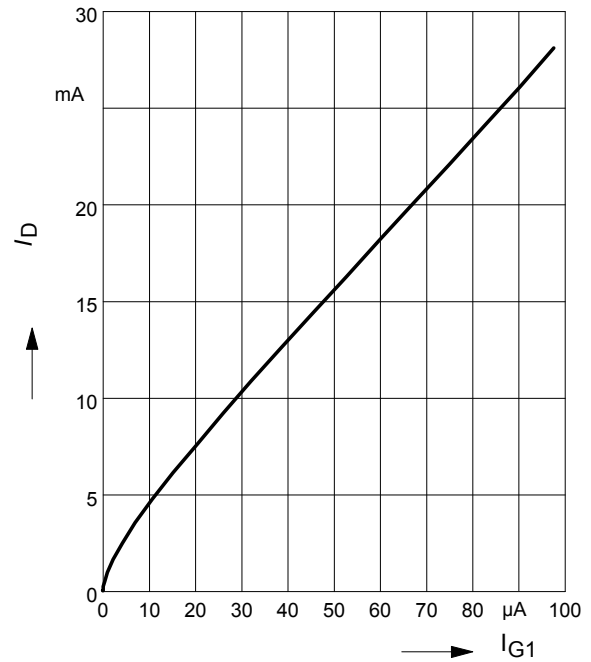
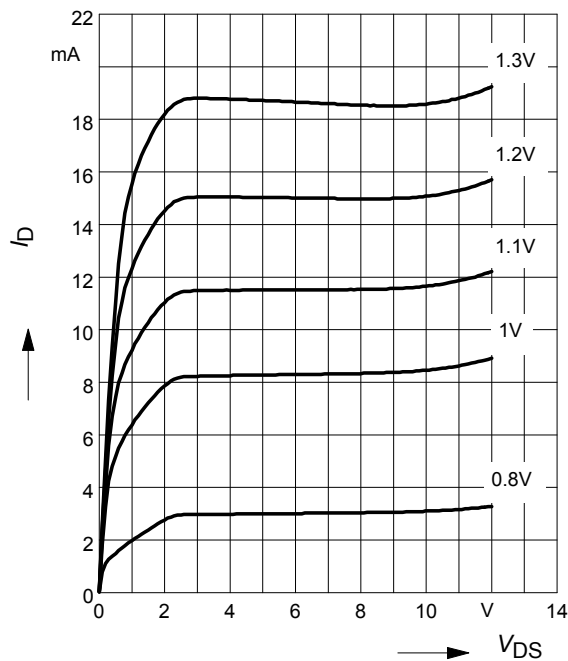
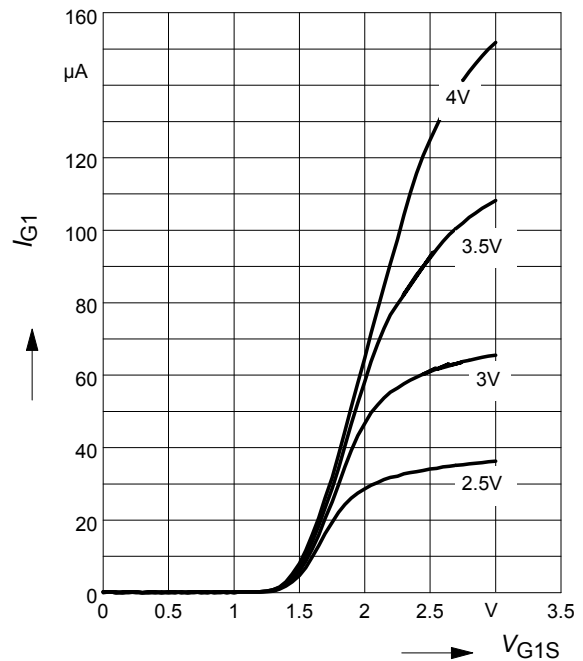
Total power dissipation $P_{tot} = f(T_S)$

Drain current $I_D = f(I_{G1})$
 $V_{G2S} = 4V$

Output characteristics $I_D = f(V_{DS})$

Gate 1 current $I_{G1} = f(V_{G1S})$
 $V_{DS} = 5V$
 $V_{G2S} = \text{Parameter}$

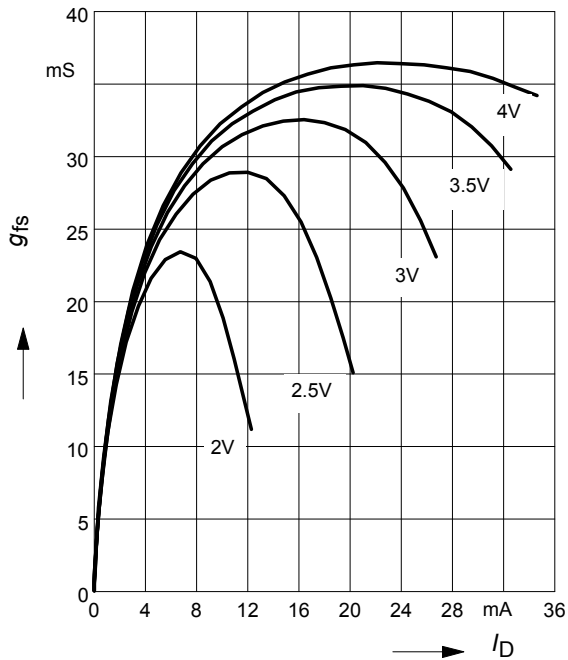
Gate 1 forward transconductance

$g_{fs} = f(I_D)$

$V_{DS} = 5V, V_{G2S} = \text{Parameter}$



Drain current $I_D = f(V_{G1S})$

$V_{DS} = 5V$

$V_{G2S} = \text{Parameter}$

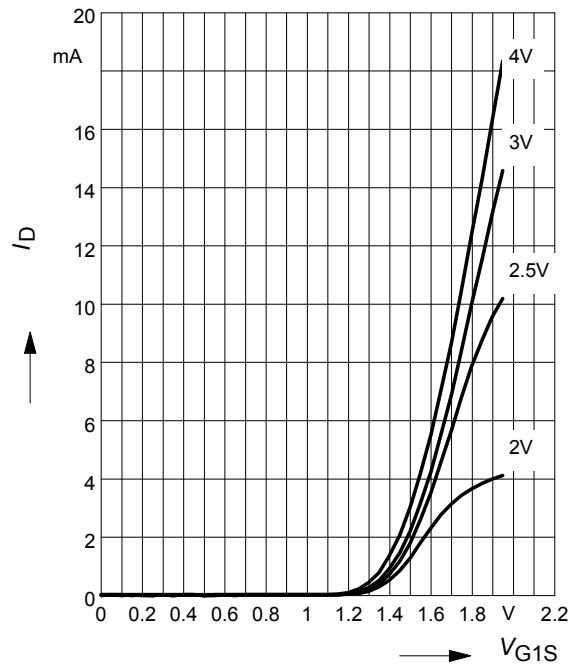

Drain current $I_D = f(V_{GG})$

$V_{DS} = 5V, V_{G2S} = 4V, R_{G1} = 80k\Omega$

(connected to V_{GG} , $V_{GG} = \text{gate1 supply voltage}$)

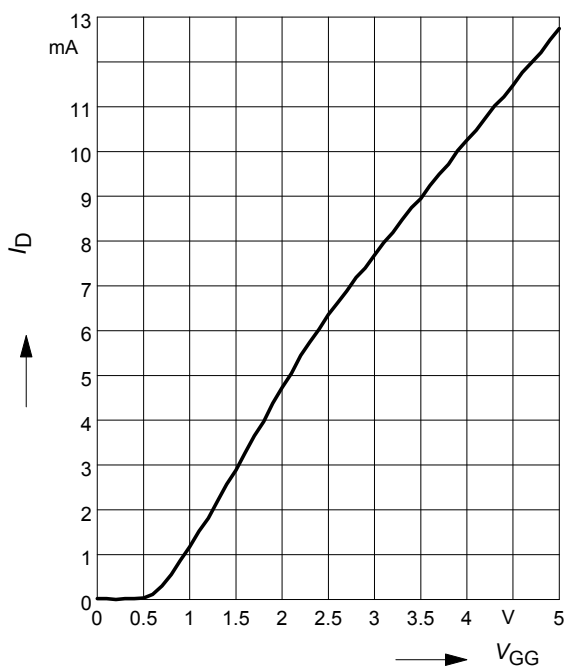

Drain current $I_D = f(V_{GG})$

$V_{G2S} = 4V$

$R_{G1} = \text{Parameter in } k\Omega$

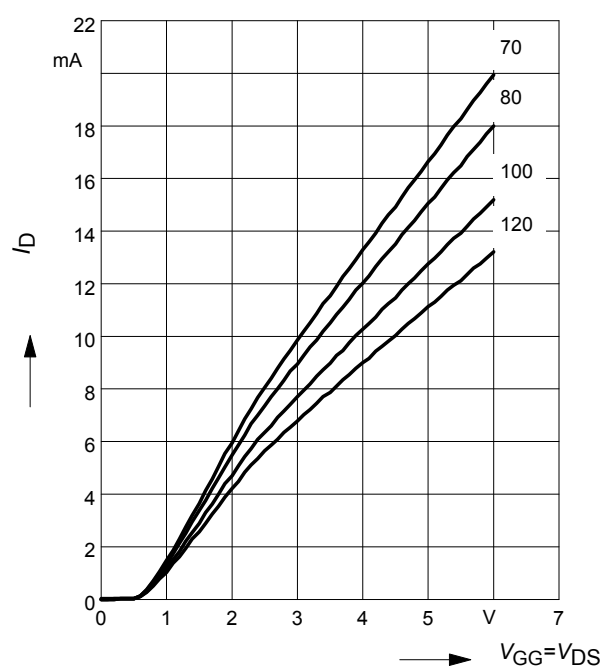

Crossmodulation $V_{unw} = (AGC)$

$V_{DS} = 5\text{ V}$, $R_{g1} = 68\text{ k}\Omega$

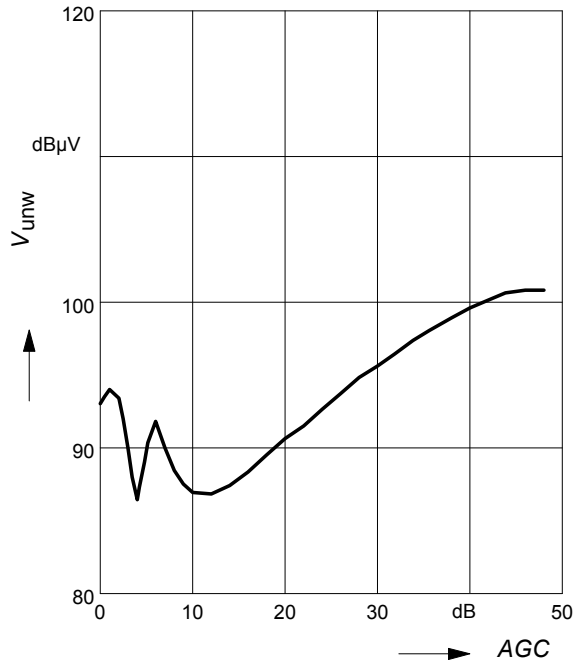

Crossmodulation test circuit

