

# POWER RELAY

## 1 POLE - 12A

### FTR-K1 Series

RoHS compliant

#### ■ FEATURES

- 12A
- 3.5mm and 5.0mm terminal pitch
- Low profile (height: 15.7mm)
- HIGH ISOLATION  
Insulation Distance (between coil and contacts): 10mm min.  
Dielectric strength: 5KV  
Surge strength: 10KV
- Low coil power (400mW)
- Cadmium free contacts
- SAFETY STANDARDS  
UL, CSA, VDE, SEMKO approved
- RoHS Compliant
- UL F class isolation wire
- VDE Glow-wire ignitability test 775 (IEC60335-1) approved



#### ■ ORDERING INFORMATION

[Example]     FTR-K1   C   K   005   W   -MA     -BG  
                   (a)    (b)    (c)    (d)    (e)    (f)            (g)

(a)	Series Name	FTR-K1 : FTR-K1 Series			
(b)	Contact Arrangement	A	: 1 form A (SPST-NO)		
		C	: 1 form C (SPDT)		
(c)	Coil Type / Enclosure	K	: Standard (400 mW) / flux free		
(d)	Nominal Voltage	005	006	009	012
		: 5 VDC,	: 6VDC,	: 9VDC	: 12VDC
		018	022	024	028
		: 18 VDC	: 022VDC	: 24VDC	: 28VDC
		048	: 48VDC		
(e)	Contact Material / TV type	W	: AgSnO2		
		E	: AgNi		
(f)	Terminal pitch	MA	: 3.5mm pitch		
		MB	: 5.0mm pitch		
(g)	Special Designation	BG	: Gold plated ; 3µm		

Actual marking does not carry the type name : "FTR"  
 E.g.: Ordering code: FTR-K1CK012W     Actual marking: K1CK012W

# FTR-K1 SERIES

## ■ PART NUMBERS

3.5mm pitch and silver tin oxide type

Ordering Part Number	Series	Contact	Coil Power	Coil Voltage	Contact Material	Terminal Pitch	
FTR-K1AK005W-MA	FTR-K1	A: 1 form A	K: 400 mW	5	W: Ag-SnO <sub>2</sub>	MA: 3.5mm	
FTR-K1AK006W-MA				6			
FTR-K1AK009W-MA				9			
FTR-K1AK012W-MA				12			
FTR-K1AK018W-MA				18			
FTR-K1AK022W-MA				22			
FTR-K1AK024W-MA				24			
FTR-K1AK028W-MA				28			
FTR-K1AK048W-MA				K: 430 mW			48
FTR-K1CK005W-MA				C: 1 form C			K: 400 mW
FTR-K1CK006W-MA		6					
FTR-K1CK009W-MA		9					
FTR-K1CK012W-MA		12					
FTR-K1CK018W-MA		18					
FTR-K1CK022W-MA		22					
FTR-K1CK024W-MA		24					
FTR-K1CK028W-MA		28					
FTR-K1CK048W-MA		K: 430 mW	48				

3.5mm pitch and silver nickel type

Ordering Part Number	Series	Contact	Coil Power	Coil Voltage	Contact Material	Terminal Pitch	
FTR-K1AK005E-MA	FTR-K1	A: 1 form A	K: 400 mW	5	E: AgNi	MA: 3.5mm	
FTR-K1AK006E-MA				6			
FTR-K1AK009E-MA				9			
FTR-K1AK012E-MA				12			
FTR-K1AK018E-MA				18			
FTR-K1AK022E-MA				22			
FTR-K1AK024E-MA				24			
FTR-K1AK028E-MA				28			
FTR-K1AK048E-MA				K: 430 mW			48
FTR-K1CK005E-MA				C: 1 form C			K: 400 mW
FTR-K1CK006E-MA		6					
FTR-K1CK009E-MA		9					
FTR-K1CK012E-MA		12					
FTR-K1CK018E-MA		18					
FTR-K1CK022E-MA		22					
FTR-K1CK024E-MA		24					
FTR-K1CK028E-MA		28					
FTR-K1CK048E-MA		K: 430 mW	48				

# FTR-K1 SERIES

5.0mm pitch and silver tin oxide type

Ordering Part Number	Series	Contact	Coil Power	Coil Voltage	Contact Material	Terminal Pitch
FTR-K1AK005W-MB	FTR-K1	A: 1 form A	K: 400 mW	5	W: Silver tin oxide	MB: 5.0mm
FTR-K1AK006W-MB				6		
FTR-K1AK009W-MB				9		
FTR-K1AK012W-MB				12		
FTR-K1AK018W-MB				18		
FTR-K1AK022W-MB				22		
FTR-K1AK024W-MB				24		
FTR-K1AK028W-MB				28		
FTR-K1AK048W-MB				K: 430 mW		
FTR-K1CK005W-MB		C: 1 form C	K: 400 mW	5		
FTR-K1CK006W-MB				6		
FTR-K1CK009W-MB				9		
FTR-K1CK012W-MB				12		
FTR-K1CK018W-MB				18		
FTR-K1CK022W-MB				22		
FTR-K1CK024W-MB				24		
FTR-K1CK028W-MB				28		
FTR-K1CK048W-MB				K: 430 mW		

5.0mm pitch and silver nickel type

Ordering Part Number	Series	Contact	Coil Power	Coil Voltage	Contact Material	Terminal Pitch
FTR-K1AK005E-MB	FTR-K1	A: 1 form A	K: 400 mW	5	E: Silver nickel	MB: 5.0mm
FTR-K1AK006E-MB				6		
FTR-K1AK009E-MB				9		
FTR-K1AK012E-MB				12		
FTR-K1AK018E-MB				18		
FTR-K1AK022E-MB				22		
FTR-K1AK024E-MB				24		
FTR-K1AK028E-MB				28		
FTR-K1AK048E-MB				K: 430 mW		
FTR-K1CK005E-MB		C: 1 form C	K: 400 mW	5		
FTR-K1CK006E-MB				6		
FTR-K1CK009E-MB				9		
FTR-K1CK012E-MB				12		
FTR-K1CK018E-MB				18		
FTR-K1CK022E-MB				22		
FTR-K1CK024E-MB				24		
FTR-K1CK028E-MB				28		
FTR-K1CK048E-MB				K: 430 mW		

# FTR-K1 SERIES

## ■ COIL DATA CHART

Coil Voltage	Nominal Voltage (VDC)	Max. Coil Voltage* <sup>1</sup>	Coil Resistance (±10%)	Must Operate Voltage* <sup>2</sup>	Must Release Voltage* <sup>2</sup>	Nominal Power (mW)
005	5	12.2 VDC	62 Ω	3.5 VDC	0.5 VDC	400
006	6	14.7 VDC	90 Ω	4.2 VDC	0.6 VDC	
009	9	22.0 VDC	202 Ω	6.3 VDC	0.9 VDC	
012	12	29.4 VDC	360 Ω	8.4 VDC	1.2 VDC	
018	18	44.1 VDC	810 Ω	12.6 VDC	1.8 VDC	
022	22	53.9 VDC	1,210 Ω	15.4 VDC	2.2 VDC	
024	24	58.8 VDC	1,440 Ω	16.8 VDC	2.4 VDC	
028	28	68.6 VDC	1,960 Ω	19.6 VDC	2.8 VDC	430
048	48	117.6 VDC	5,360 Ω	33.6 VDC	4.8 VDC	

Note: All values in the table are measured at 20°C.

\*1: No contact current at 20°C

\*2: Specified values are subject to pulse wave voltage

## ■ SPECIFICATIONS

Item		FTR-K1 (A, C)K ( ) (W, E)-MA	FTR-K1 (A, C)K ( ) (W, E)-MB
Contact	Arrangement	1 form A, 1 form C	
	Material	W: AgSnO <sub>2</sub> , E: AgNi	
	Resistance (initial)	Maximum 100 mΩ at 1 A, 6 VDC	
	Rating	12 A, 250 VAC / 24 VDC	
	Maximum Carrying Current* <sup>1</sup>	14 A	
	Maximum Switching Rating	3,000 VA / 288W	
	Maximum Switching Voltage	440 VAC / 300VDC	
	Minimum Switching Load* <sup>2</sup>	10 mA 5 VDC	
Coil	Nominal Power (at 20°C)	400mW (at 430mW 48V coil)	
	Operate Power (at 20°C)	200 mW (210mW at 48V coil)	
	Operating Temperature	-40°C to +85°C (no frost)	
Time Value	Operate	Maximum 15ms (at nominal voltage, no bounce)	
	Release (without diode)	Maximum 5ms (at nominal voltage, no bounce)	
Life	Mechanical	20 x 10 <sup>6</sup> operations minimum	
	Electrical	AC Contact rating	100 x 10 <sup>3</sup> operations min.
		DC contact rating	100 x 10 <sup>3</sup> operations min.
Other	Vibration Resistance	Misoperation	10 to 55 Hz, at double amplitude of 0.7 mm
		Endurance	10-55Hz, at double amplitude of 1.5 mm
	Shock Resistance	Misoperation	Min. 100m/s <sup>2</sup> (11±1ms)
		Endurance	Min. 1,000m/s <sup>2</sup> (6±1ms)
	Weight	Approximately 13g	

\*1 Need to consider the heat from PCB when max. current is more than 10A.

\*2 Minimum switching loads mentioned above are reference values. Please perform the confirmation test with the actual load before production since reference values may vary according to switching frequencies, environmental conditions and expected reliability levels.

# FTR-K1 SERIES

## ■ INSULATION

Item	FTR-K1	Note
Resistance (initial)	Minimum 1,000 MΩ 1 min.	at 500 VDC
Dielectric Strength	open contacts	1,000 VAC (50/60 Hz) 1 min.
	coil and contacts	5,000 VAC (50/60 Hz) 1 min.
Surge Voltage (coil and contact)	10,000 V	1.2 x 50µs standard wave
Clearance/Creepage	10 mm / 10 mm	
Insulation (DIN EN61810-1 VDE0435)		
Voltage	250 V	
Pollution	3	
Isolation material group	IIIa	
Isolation category / Reference voltage (VDE0110b)	C / 250 V	

## ■ SAFETY STANDARDS

Type	Compliance	Contact rating	
UL	UL 508	Flammability: UL 94-V0 (plastics)	
	E63614	<table border="1"> <tr> <td>FTR-K1CK( )W-(MA, MB) 12A, 24 VAC (resistive) 16A, 277 VAC (resistive) 1/2 HP, 277VAC 1/3HP, 3 HP, 125VAC 1/8HP, 125VAC Pilot duty: B300</td> <td>FTR-K1AK( )W-(MA, MB) 16A, 24 VAC (resistive) 16A, 277 VAC (resistive) 1/2 HP, 277VAC 1/3HP, 3 HP, 125VAC Pilot duty: B300</td> </tr> </table>	FTR-K1CK( )W-(MA, MB) 12A, 24 VAC (resistive) 16A, 277 VAC (resistive) 1/2 HP, 277VAC 1/3HP, 3 HP, 125VAC 1/8HP, 125VAC Pilot duty: B300
FTR-K1CK( )W-(MA, MB) 12A, 24 VAC (resistive) 16A, 277 VAC (resistive) 1/2 HP, 277VAC 1/3HP, 3 HP, 125VAC 1/8HP, 125VAC Pilot duty: B300	FTR-K1AK( )W-(MA, MB) 16A, 24 VAC (resistive) 16A, 277 VAC (resistive) 1/2 HP, 277VAC 1/3HP, 3 HP, 125VAC Pilot duty: B300		
CSA	C22.2 No. 14 LR 40304	FTR-K1(A,C)K( )W-(MA, MB) 12A, 277VAC/24 VAC (resistive) 16A, 277 VAC/24VAC (resistive) 1/2 HP, 277VAC 1/3HP, 3 HP, 125VAC Pilot duty: B300	
VDE	0435, 0631, 0700, 0860, 40013848	FTR-K1(A, C) K ( )W-(MA, MB) 12A, 250 VAC (cosØ=1), 85°C 16A, 250 VAC (cosØ=1), 85°C 12A, 24VDC (0ms), 85°C 16A, 24VDC (0ms), 85°C 3.5A, 250 VAC (cosØ=0.4), 85°C	
SEMKO	EN 61058-1:1992 and A1 EN 61095:1993 and A1+A11	250VAC, 12 (3)A 40T85	

Complies with NEMKO, DEMKO, FIMKO

## CHARACTERISTIC DATA

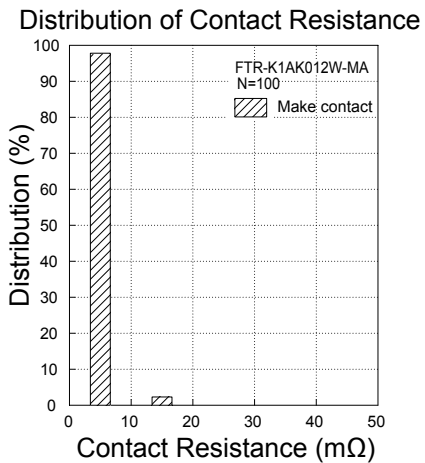
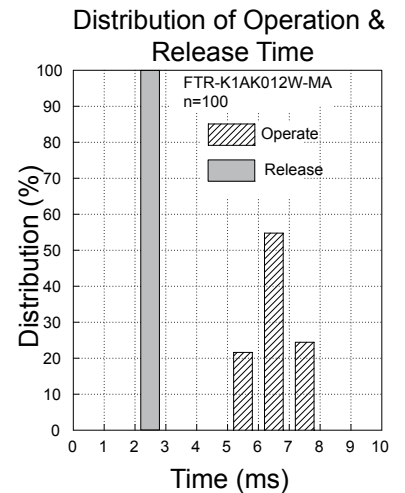
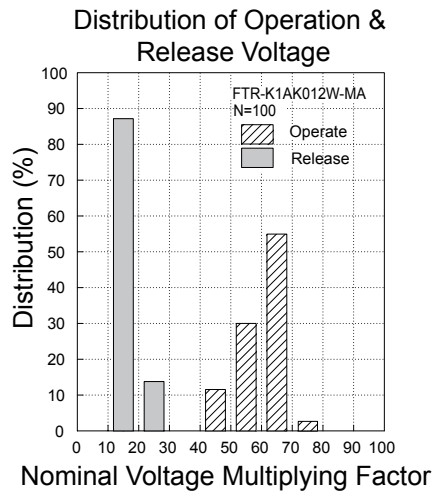
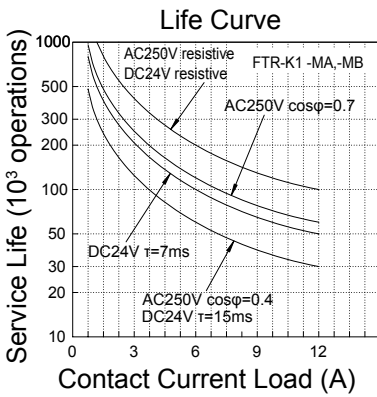
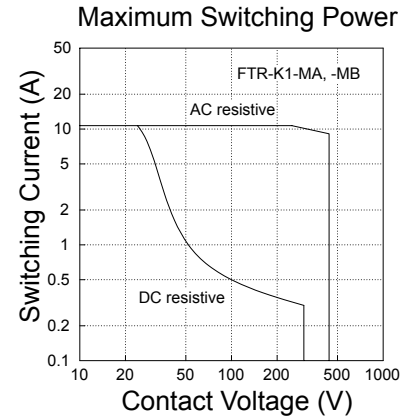
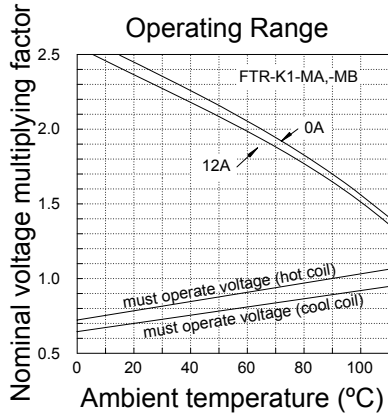
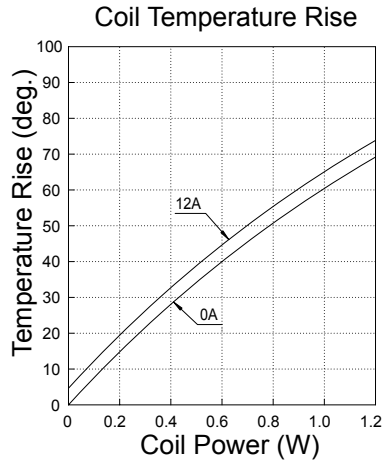

# FTR-K1 SERIES

## ■ DIMENSIONS

### ● Dimensions

FTR-K1MA

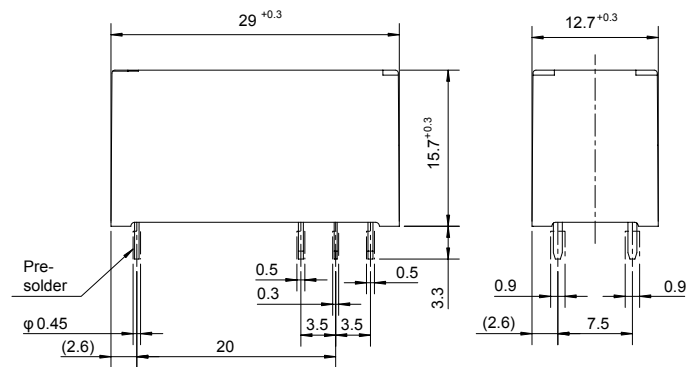

### ● Schematics (BOTTOM VIEW)

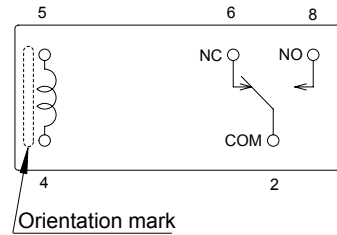

### ● PC board mounting hole layout (BOTTOM VIEW)

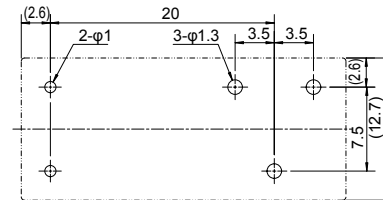

### ● Dimensions

FTR-K1MB

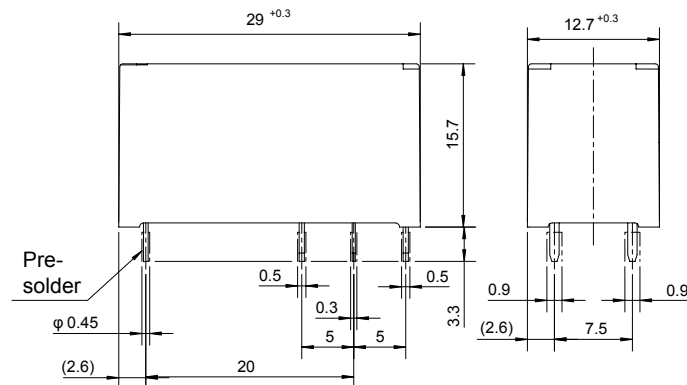

### ● Schematics (BOTTOM VIEW)

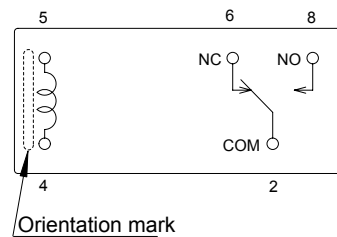

### ● PC board mounting hole layout (BOTTOM VIEW)

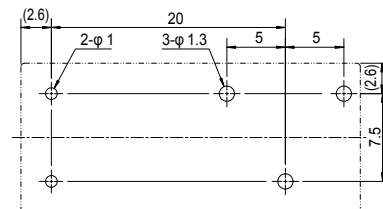

Unit: mm

## RoHS Compliance and Lead Free Relay Information

### 1. General Information

- Relays produced after the specific date code that is indicated on each data sheet are lead-free now. All of our signal and power relays are lead-free. Please refer to Lead-Free Status Info. (<http://www.fujitsu.com/us/downloads/MICRO/fcai/relays/lead-free-letter.pdf>)
- Lead free solder paste currently used in relays is Sn-3.0Ag-0.5Cu.
- All signal and power relays also comply with RoHS. Please refer to individual data sheets. Relays that are RoHS compliant do not contain the 5 hazardous materials that are restricted by RoHS directive (lead, mercury, chromium IV, PBB, PBDE, DecaBDE).
- It has been verified that using lead-free relays in leaded assembly process will not cause any problems (compatible).
- "LF" is marked on each outer and inner carton. (No marking on individual relays).

Note: Cadmium was exempted from RoHS on October 21, 2005. (Amendment to Directive 2002/95/EC)

### 2. Recommended Lead Free Solder Profile

- Recommended solder paste Sn-3.0Ag-0.5Cu.

#### Solder condition

**Flow Solder condition:**

Pre-heating: maximum 120°C  
Soldering: dip within 5 sec. at  
260°C solder bath

**Solder by Soldering Iron:**

Soldering Iron  
Temperature: maximum 360°C  
Duration: maximum 3 sec.

**We highly recommend that you confirm your actual solder conditions**

### 3. Moisture Sensitivity

- Moisture Sensitivity Level standard is not applicable to electromechanical relays.

### 4. Tin Whisker

- Dipped SnAgCu solder is known as low risk tin whisker. No considerable length whisker was found by our in house test.



## Fujitsu Components International Headquarter Offices

### Japan

Fujitsu Component Limited  
Gotanda-Chuo Building  
3-5, Higashigotanda 2-chome, Shinagawa-ku  
Tokyo 141, Japan  
Tel: (81-3) 5449-7010  
Fax: (81-3) 5449-2626  
Email: [promothq@ft.ed.fujitsu.com](mailto:promothq@ft.ed.fujitsu.com)  
Web: [www.fcl.fujitsu.com](http://www.fcl.fujitsu.com)

### North and South America

Fujitsu Components America, Inc.  
250 E. Caribbean Drive  
Sunnyvale, CA 94089 U.S.A.  
Tel: (1-408) 745-4900  
Fax: (1-408) 745-4970  
Email: [components@us.fujitsu.com](mailto:components@us.fujitsu.com)  
Web: <http://www.fujitsu.com/us/services/edevice/components/>

### Europe

Fujitsu Components Europe B.V.  
Diamantlaan 25  
2132 WV Hoofddorp  
Netherlands  
Tel: (31-23) 5560910  
Fax: (31-23) 5560950  
Email: [info@fceu.fujitsu.com](mailto:info@fceu.fujitsu.com)  
Web: [emea.fujitsu.com/components/](http://emea.fujitsu.com/components/)

### Asia Pacific

Fujitsu Components Asia Ltd.  
102E Pasir Panjang Road  
#01-01 Citilink Warehouse Complex  
Singapore 118529  
Tel: (65) 6375-8560  
Fax: (65) 6273-3021  
Email: [fcal@fcal.fujitsu.com](mailto:fcal@fcal.fujitsu.com)  
Web: <http://www.fujitsu.com/sg/services/micro/components/>

©2008 Fujitsu Components America, Inc. All rights reserved. All trademarks or registered trademarks are the property of their respective owners.

Fujitsu Components America or its affiliates do not warrant that the content of datasheet is error free. In a continuing effort to improve our products Fujitsu Components America, Inc. or its affiliates reserve the right to change specifications/datasheets without prior notice.  
Rev. July 21, 2008.