

ISOLATED AC-DC Converter

AC100 SERIES

APPLICATION NOTE

Rev C



Content

1. INTRODUCTION	3
2. AC100 CONVERTER FEATURES	3
3. GENERAL DESCRIPTION	3
ABSOLUTE MAXIMUM RATINGS	4
5. MAIN FEATURES AND FUNCTIONS	6
5.1 Operating Temperature Range	6
5.2 Output Voltage Adjustment	6
5.3 Over Current Protection	6
5.4 Over Voltage Protection	6
5.5 V-Sense	6
6. SAFETY	6
7. APPLICATIONS	6
7.1 Power De-Rating Curves	7
7.2 Efficiency vs. Load Curves	9
7.3 Test Set-Up	11
7.4 Output Ripple and Noise Measurement	11
7.5 Output Capacitance	11
7.6 EMI	11
8. MECHANICAL OUTLINE DIAGRAMS	12
8.1 AC100 Mechanical Outline Diagrams	12
9. INSTALLATION INSTRUCTION	12
10. PART NIMBER	14

1. Introduction

This application note describes the features and functions of Intronics power's AC100 series of open frame, Isolated AC-DC Converters. These are highly efficient, reliable and compact, high power density, single output AC/DC converters. Ultra-high efficiency operation is achieved through the use of synchronous rectification and drive control techniques. The modules are fully protected against short circuit and over-voltage conditions. Intronics power's world class automated manufacturing methods, together with an extensive testing and qualification program; ensure that all AC100 series converters are extremely reliable.

2. AC100 Converter Features

- 100W Isolated Output
- High Efficiency Up to 85%
- Fixed Switching Frequency
- Power factor correction Up to 0.9

- Universal Input Range
- Regulated Outputs
- Continuous Short Circuit Protection
- 3" X 5" size
- Open-Frame Type

3. General Description

A block diagram of the AC100 series converter is shown in Figure 1. Extremely high efficiency power conversion is achieved through the use of synchronous rectification and drive techniques. Essentially, the powerful AC100 series topology is based on an isolated synchronous forward converter. The control loop is optimized for unconditional stability, fast transient response and a very tight line and load regulation. The output voltage can be adjusted from +5% to -5%, using a variable resistor.

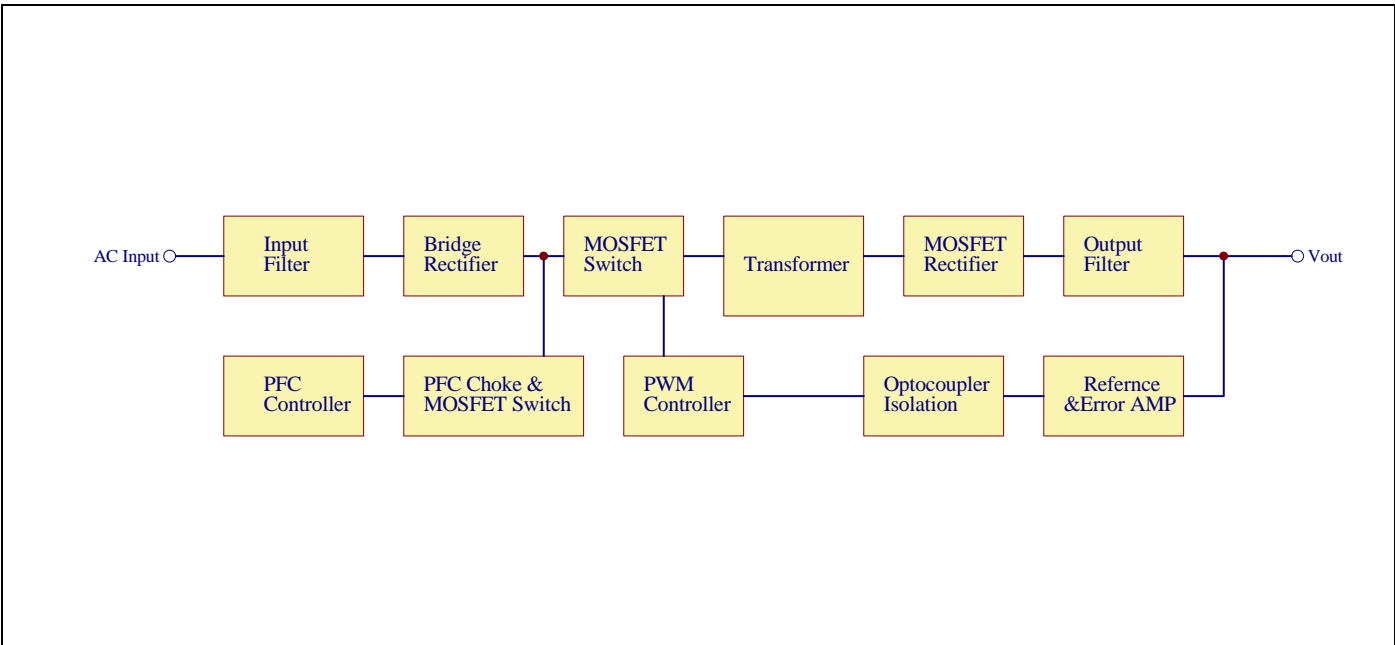

Figure 1. Electrical Block Diagram

4. Technical Specifications

(All specifications are typical at nominal input, full load at 25°C unless otherwise noted.)

PARAMETER	NOTES and CONDITIONS	Device	Min.	Typical	Max.	Units
ABSOLUTE MAXIMUM RATINGS						
Input Voltage						
Continuous			90		264	Vdc
Operating Temperature			0		+40	°C
Storage Temperature			-20		+85	°C
Input/Output Isolation Voltage	1 minute		4242			Vdc
INPUT CHARACTERISTICS						
Operating Voltage Range			100		240	Vac
Input Frequency Range			47		63	Hz
Maximum Input Current	100% Load, Vin=90Vac			1.5		A
Power factor correction	100% Load, Vin=Nominal Vin			0.9		
No-Load Input Power	Vin=264Vac	AC100S050 AC100S090 AC100S120 AC100S150 AC100S180 AC100S240 AC100S480		7.0 6.0 5.0 5.0 5.0 5.0 4.0		W
Leakage Current					3.5	mA
Inrush Current	Vin=240Vac, cold start at 25°C.				80	A
OUTPUT CHARACTERISTIC						
Output Voltage Set Point	Vin=Nominal Vin , Io=Io.max, Tc=25°C	AC100S050 AC100S090 AC100S120 AC100S150 AC100S180 AC100S240 AC100S480	4.95 8.91 11.88 14.85 17.82 23.76 47.52	5.0 9.0 12.0 15.0 18.0 24.0 48.0	5.05 9.09 12.12 15.15 18.18 24.24 48.48	Vdc
Operating Output Current Range		AC100S050 AC100S090 AC100S120 AC100S150 AC100S180 AC100S240 AC100S480		20.0 11.2 8.4 6.7 5.6 4.2 2.1		A
Holdup Time	Vin=115Vac			20		mS
Output Voltage Regulation						
Load Regulation	10% load to Full load				±1.0	%
Line Regulation	Vin=high line to low line				±0.5	%
Output Voltage Ripple and Noise	20MHz bandwidth					
Peak-to-Peak	Full load, 0.1uF ceramic and 220uF E.L capacitor	AC100S050 AC100S090 AC100S120			100 90 120	mV
	Full load, 0.1uF ceramic and 10uF E.L capacitor	AC100S150 AC100S180 AC100S240 AC100S480			150 180 240 480	mV

PARAMETER	NOTES and CONDITIONS	Device	Min.	Typical	Max.	Units
Output Current-Limit	Output Voltage =90% Nominal Output Voltage		110	130	150	%
Output Voltage-Limit			110	130	150	%
Turn-On Transient						
Start-Up Time, From Input	Vin=90Vac				5	s
Maximum Output Capacitance	Vin=Nominal Vin at Full load	AC100S050 AC100S090 AC100S120 AC100S150 AC100S180 AC100S240 AC100S480			20000 12000 8400 6700 5600 4200 2100	uF
EFFICIENCY						
100% Load		AC100S050 AC100S090 AC100S120 AC100S150 AC100S180 AC100S240 AC100S480		82 85 85 85 85 85		%
ISOLATION CHARACTERISTICS						
Input to Output	1 minute				4242	Vdc
Input to Earth	1 minute				2121	Vdc
Output to Earth	1 minute				707	Vdc
Isolation Resistance			100			MΩ
FEATURE CHARACTERISTICS						
Switching Frequency				67		KHz
Output Voltage Adjustment	Pout=max rated power		-5		+5	%
GENERAL SPECIFICATIONS						
MTBF	Io=100%of Io.max;Ta=25°C per MIL-HDBK-217F			TBD		M hours
Weight				0.385		Kg

5. Main Features and Functions

5.1 Operating Temperature Range

Intronics power's AC100 series converters highly efficient converter design has resulted in its ability to operate ambient temperature environment (0°C to 40°C). Due consideration must be given to the de-rating curves when ascertaining maximum power that can be drawn from the converter. The maximum power drawn is influenced by a number of factors, such as:

- Input voltage range.
- Output load current.
- These can be effective heat sinks for the converter.

5.2 Output Voltage Adjustment

The output voltage on all models is in the range from +5% to -5% but can't exceed the watt value of the products .

5.3 Over Current Protection

All different voltage models have a full continuous short-circuit protection. The unit will auto recover once the short circuit is removed. To provide protection in a fault condition, the unit is equipped with internal over-current protection. The unit operates normally once the fault condition is removed. The power module will supply up to 150% of rated current. In the event of an over current converter will go into a hiccup mode protection.

5.4 Over Voltage Protection

All different voltage models have a full continuous over voltage protection. The power module will supply up to 150% of rated voltage. In the event of an over voltage converter will go into a hiccup mode protection.

5.5 V-Sense

V-sense measures the use as outputting the voltage. The maximum length of the sense lines is 1200mm. The min gauge wire that can be used 26AWG.

If does not use and needn't need to join .

6. Safety

- CB Approval
- TUV Approval
- UL Approval

7. Applications

7.1 Power De-Rating Curves

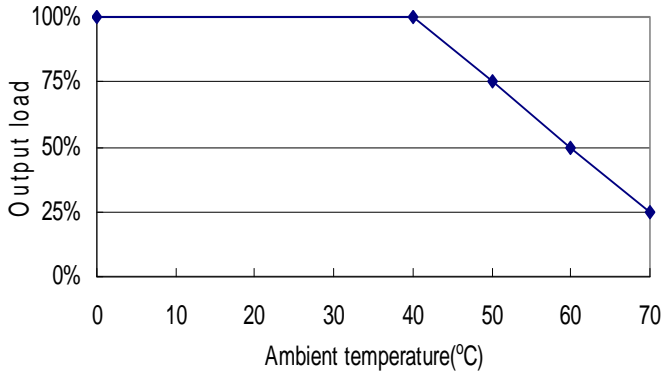

Figure 6a. Typical Power De-rating for AC100S050

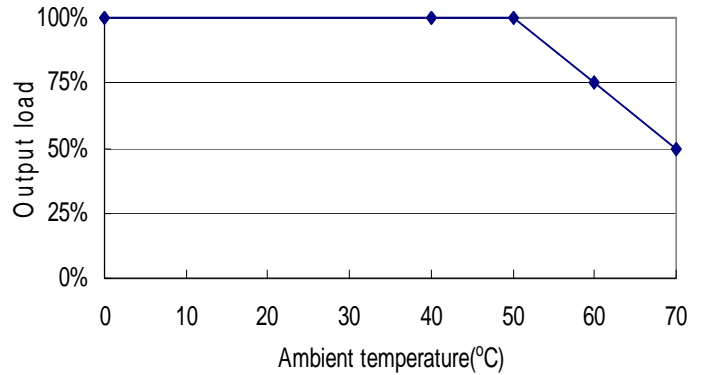

Figure 6b. Typical Power De-rating for AC100S090

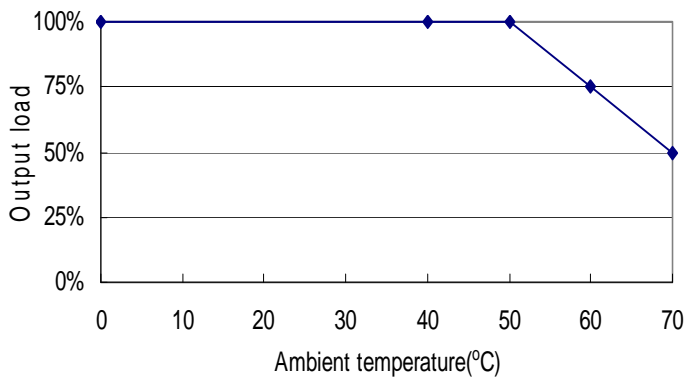

Figure 6c. Typical Power De-rating for AC100S120

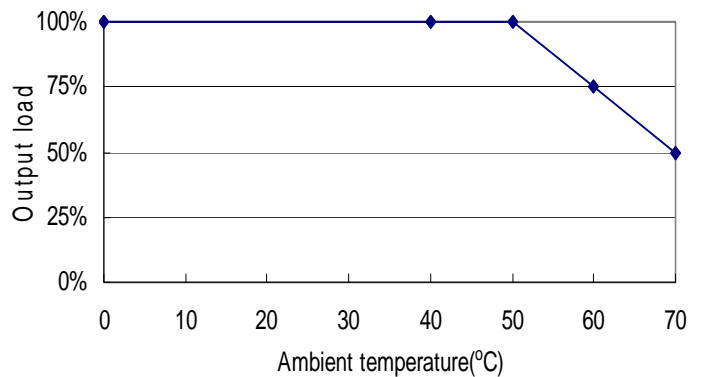

Figure 6d. Typical Power De-rating for AC100S150

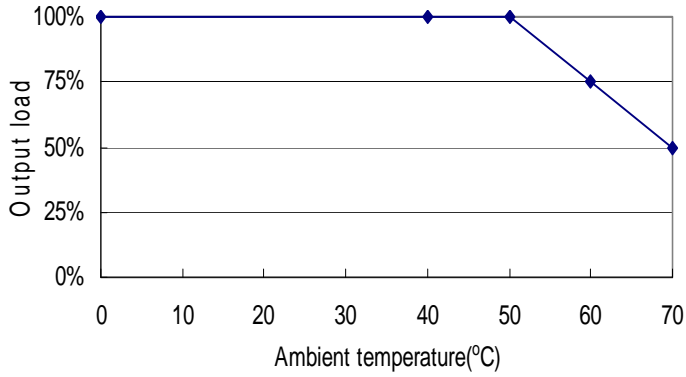

Figure 6g. Typical Power De-rating for AC100S180

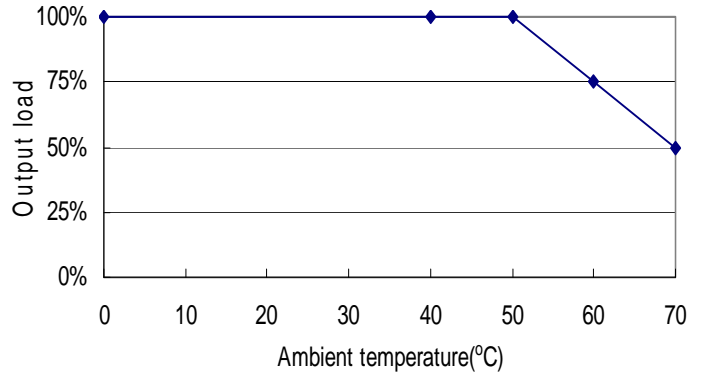

Figure 6h. Typical Power De-rating for AC100S240

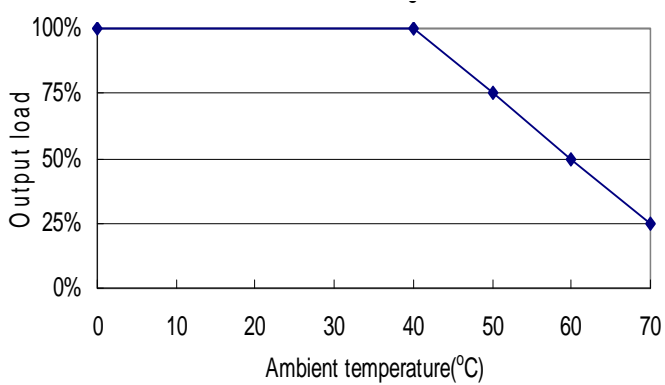

Figure 6i. Typical Power De-rating for AC100S480

7.2 Efficiency vs. Load Curves

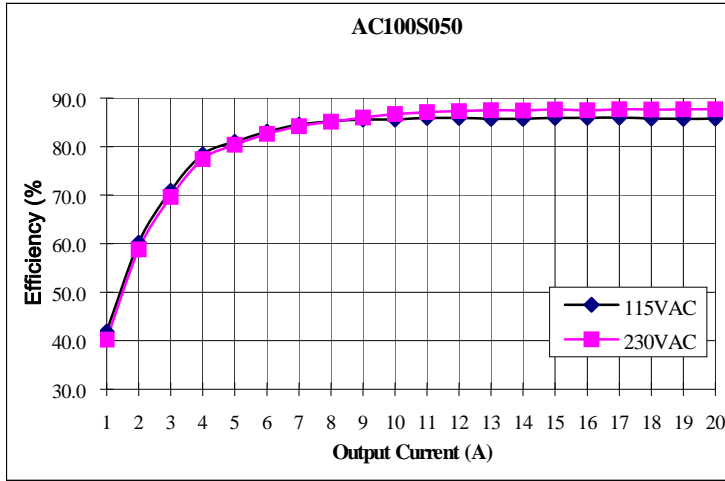

Figure 7a. AC100S050

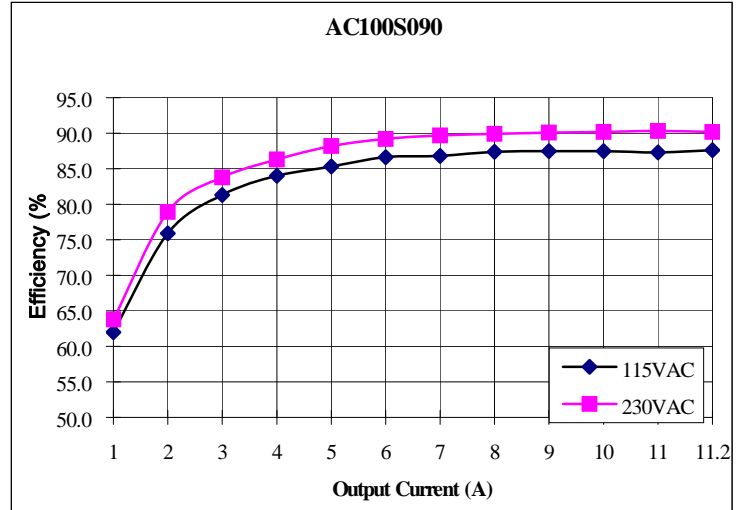

Figure 7b. AC100S090

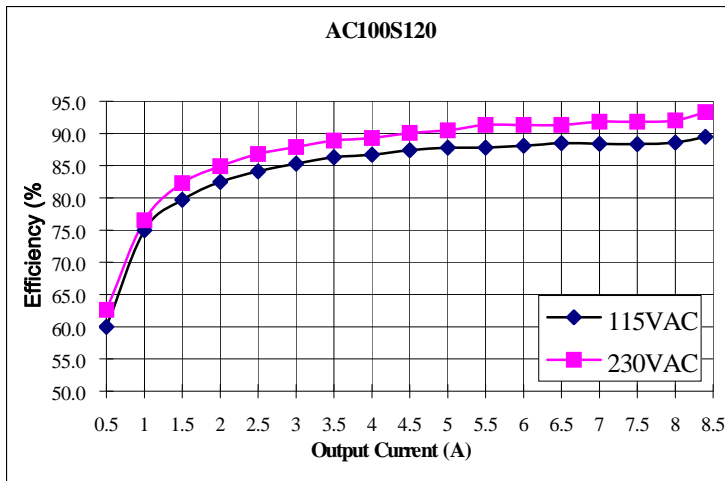

Figure 7c. AC100S120

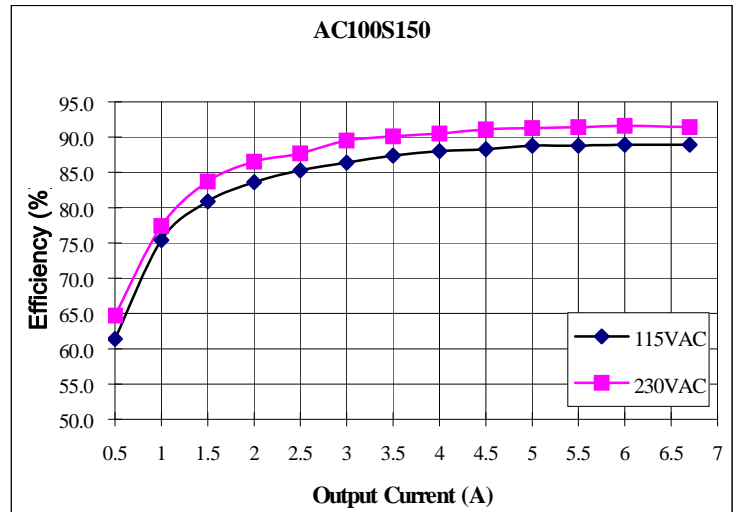

Figure 7d. AC100S150

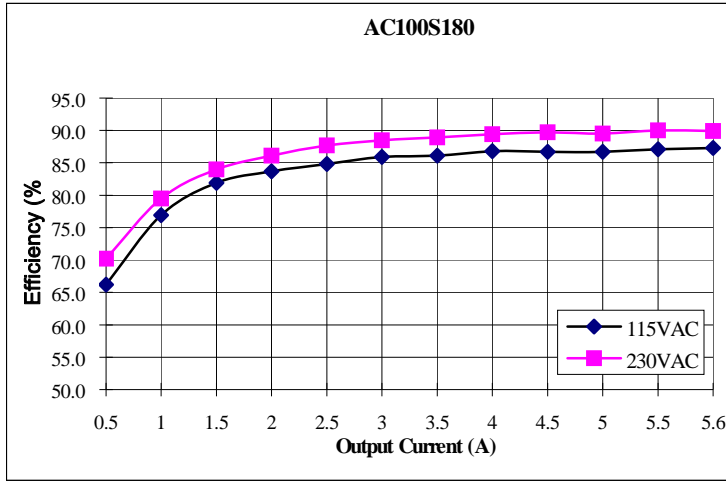

Figure 7g. AC100S180

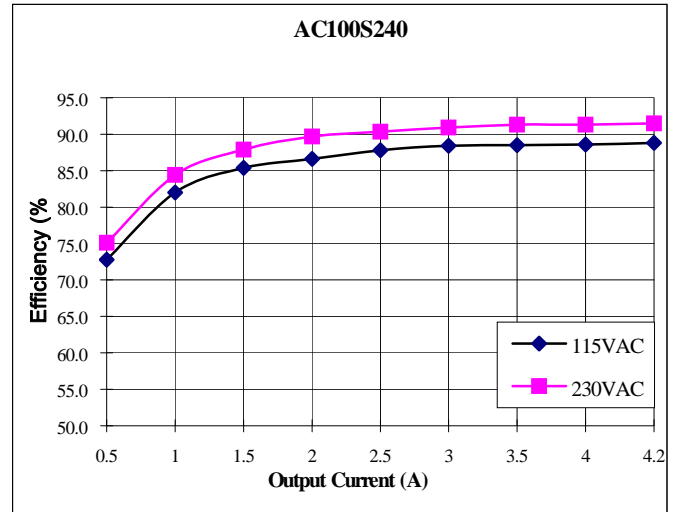

Figure 7h. AC100S240

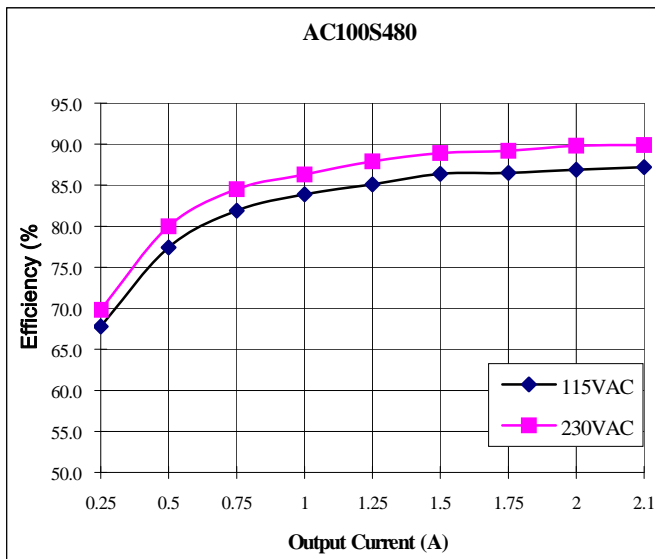

Figure 7i. AC100S480

7.3 Test Set-Up

The basic test set-up to measure parameters such as efficiency and load regulation is shown in Figure 8. When testing the Intronics power's AC100 series under any transient conditions please ensure that the transient response of the source is sufficient to power the equipment under test. We can calculate the

- Efficiency
- Load regulation and line regulation.

The value of efficiency is defined as:

$$\eta = \frac{V_o \times I_o}{P_{in}} \times 100\%$$

Where: V_o is output voltage,
 I_o is output current,
 P_{in} is input power,

The value of load regulation is defined as:

$$Load.reg = \frac{V_{FL} - V_{NL}}{V_{NL}} \times 100\%$$

Where: V_{FL} is the output voltage at full load
 V_{NL} is the output voltage at 10% load

The value of line regulation is defined as:

$$Line.reg = \frac{V_{HL} - V_{LL}}{V_{LL}} \times 100\%$$

Where: V_{HL} is the output voltage of maximum input voltage at full load.
 V_{LL} is the output voltage of minimum input voltage at full load.

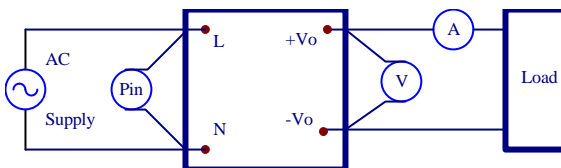

Figure 8. AC100 Series Test Setup

7.4 Output Ripple and Noise Measurement

The test set-up for noise and ripple measurements is shown in Figure 10. Measured method :

Add a terminal wire is 50mmMIN that the output end needs to connect the sub length of line of one end .

1. Add a 0.1 uF ceramic capacitor and a 220 uF electrolytic capacitor to output at 20 MHz Band Width for AC100S050 , AC100S090 and AC100S120.
2. Add a 0.1 uF ceramic capacitor and a 10 uF electrolytic capacitor to output at 20 MHz Band Width for AC100S150 , AC100S180 , AC100S240 and AC100S480.

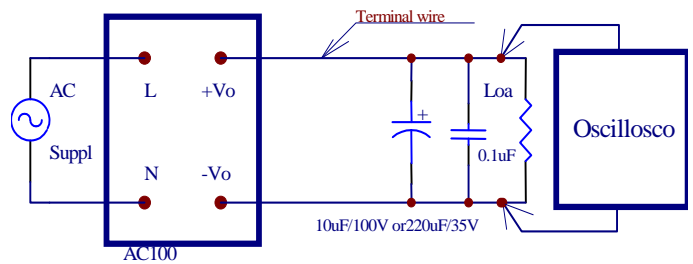

Figure 10. Output Voltage Ripple and Noise Measurement Set-Up

7.5 Output Capacitance

Intronics power' AC100 series converters provide unconditional stability with or without external capacitors. Intronics power' converters are designed to work with load capacitance up-to 1000uF per amp.

7.6 EMI

- **Conductive EMI meets CISPR/FCC Class B**

8. Mechanical Outline Diagrams

8.1 AC100 Mechanical Outline Diagrams

Dimensions are in millimeters

Tolerance: $x.x \pm 0.5\text{mm}$, unless otherwise noted

Annotations : All models height does not exceed 34mmMAX .

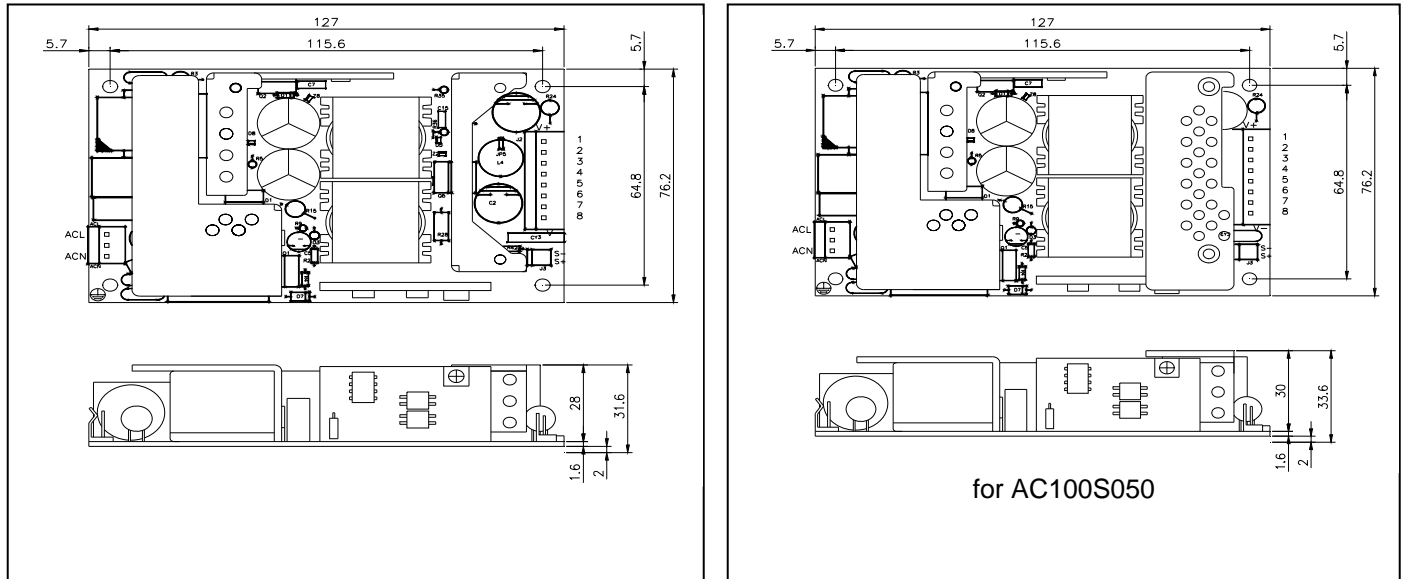
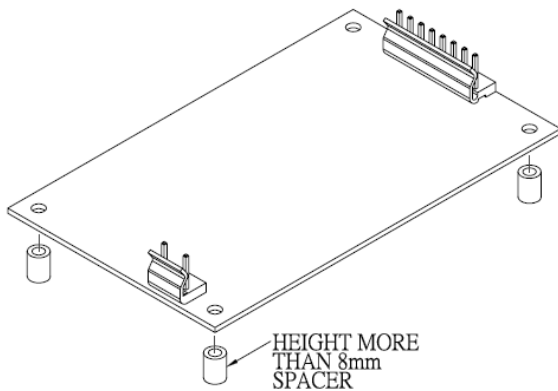

Figure 11. AC100 Mechanical Outline Diagram

9. Installation Instruction

Please use the mounting hold as: AC100S series : 4 holds of $\psi 3.17$

And insert the spacer (Max $\psi 6$) of height over 8mm to lift the unit .The vibration spec. is the value take when the unit is raised by 8mm spacers.



Please reserve 4mm space from the surfaces and the sides of PCB, especially from the solder surface, 8mm space is necessary. If the space is not enough, the specification of insulation and withstand will not be satisfied.

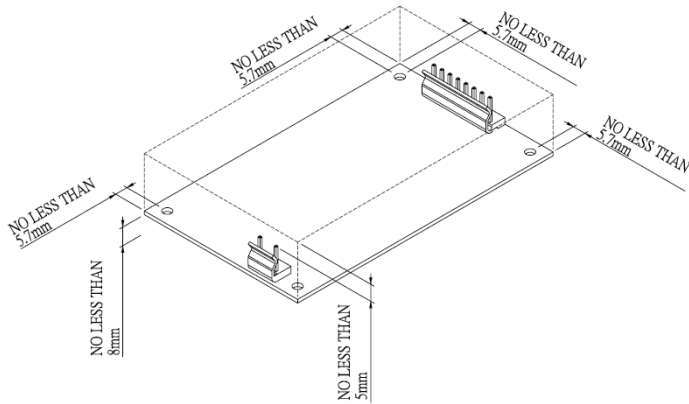

FG should be connected to the earth terminal of the apparatus. If not, the conducted noise and output noise will increase.

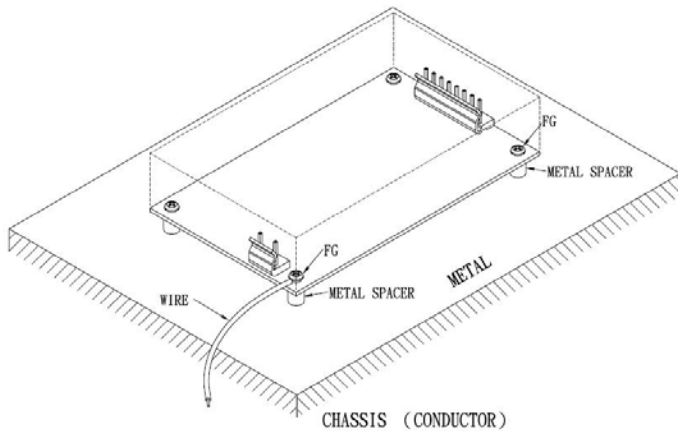

10. Part Number

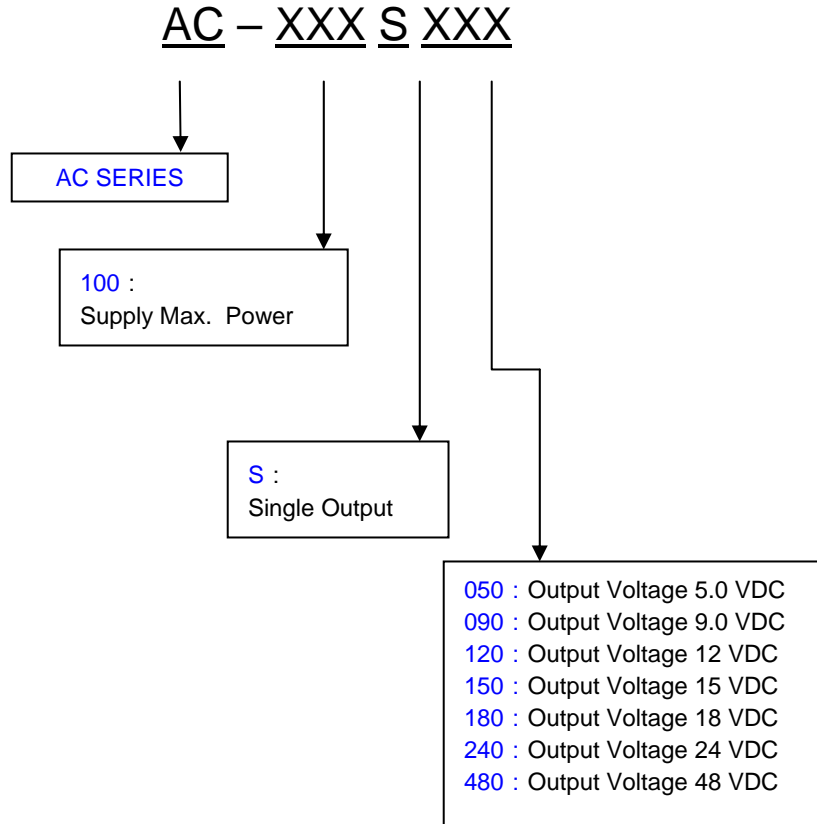

INTRONICS POWER INCORPORATED.