

### FEATURES

- 16-bit resolution with no missing codes
- Throughput: 100 kSPS
- INL:  $\pm 1$  LSB typ,  $\pm 3$  LSB max
- Pseudodifferential analog input range
- 0 V to  $V_{REF}$  with  $V_{REF}$  up to VDD
- Single-supply operation: 2.7 V to 5.5 V
- Serial interface SPI<sup>®</sup>/QSPI<sup>™</sup>/MICROWIRE<sup>™</sup>/DSP-compatible
- Power dissipation : 4 mW @ 5 V, 1.5 mW @ 2.7 V,  
150  $\mu$ W @ 2.7 V/10 kSPS
- Standby current: 1 nA
- 8-lead package: MSOP package and  
3 mm  $\times$  3 mm QFN<sup>1</sup> (LFCSP) (SOT-23 size)
- Improved 2<sup>nd</sup> source to ADS8320 and ADS8325

### APPLICATIONS

- Battery-powered equipment
- Data acquisition
- Instrumentation
- Medical instruments
- Process control

### APPLICATION DIAGRAM

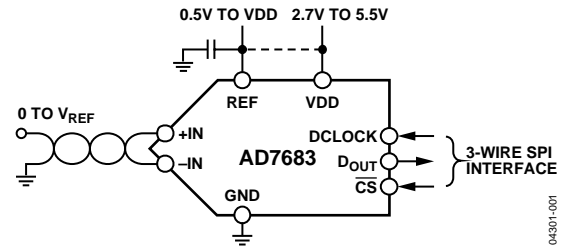

Figure 1.

Table 1. MSOP, QFN (LFCSP)/SOT-23, 16-Bit PuLSAR ADC

Type	100 kSPS	250 kSPS	500 kSPS
True Differential	AD7684	AD7687	AD7688
Pseudo Differential/Unipolar	AD7683	AD7685 AD7694	AD7686
Unipolar	AD7680		

### GENERAL DESCRIPTION

The AD7683 is a 16-bit, charge redistribution, successive approximation, PuLSAR<sup>™</sup> analog-to-digital converter (ADC) that operates from a single power supply, VDD, between 2.7 V to 5.5 V. It contains a low power, high speed, 16-bit sampling ADC with no missing codes (B grade), an internal conversion clock, and a serial, SPI-compatible interface port. The part also contains a low noise, wide bandwidth, short aperture delay, track-and-hold circuit. On the  $\overline{CS}$  falling edge, it samples an analog input, +IN, between 0 V to REF with respect to a ground sense, -IN. The reference voltage, REF, is applied externally and can be set up to the supply voltage. Its power scales linearly with throughput.

The AD7683 is housed in an 8-lead MSOP or an 8-lead QFN (LFCSP) package, with an operating temperature specified from  $-40^{\circ}\text{C}$  to  $+85^{\circ}\text{C}$ .

<sup>1</sup> QFN package in development. Contact factory for samples and availability.

### Rev. 0

Information furnished by Analog Devices is believed to be accurate and reliable. However, no responsibility is assumed by Analog Devices for its use, nor for any infringements of patents or other rights of third parties that may result from its use. Specifications subject to change without notice. No license is granted by implication or otherwise under any patent or patent rights of Analog Devices. Trademarks and registered trademarks are the property of their respective owners.

## TABLE OF CONTENTS

Specifications.....	3	Typical Connection Diagram .....	13
Timing Specifications.....	5	Analog Input .....	13
Absolute Maximum Ratings.....	6	Driver Amplifier Choice.....	13
ESD Caution.....	6	Voltage Reference Input .....	14
Pin Configuration and Functional Descriptions.....	7	Power Supply.....	14
Terminology .....	8	Digital Interface .....	14
Typical Performance Characteristics .....	9	Layout .....	14
Application Information.....	12	Evaluating the AD7683's Performance .....	14
Circuit Information.....	12	Outline Dimensions .....	15
Converter Operation.....	12	Ordering Guide .....	15
Transfer Functions.....	12		

## REVISION HISTORY

9/04—Initial Version: Revision 0

## SPECIFICATIONS

VDD = 2.7 V to 5.5 V; V<sub>REF</sub> = VDD; T<sub>A</sub> = -40°C to +85°C, unless otherwise noted.

Table 2.

Parameter	Conditions	AD7683 All Grades			Unit
		Min	Typ	Max	
RESOLUTION		16			Bits
ANALOG INPUT					
Voltage Range	+IN – (–IN)	0		V <sub>REF</sub>	V
Absolute Input Voltage	+IN	–0.1		VDD + 0.1	V
	–IN	–0.1		0.1	V
Analog Input CMRR	f <sub>IN</sub> = 100 kHz		65		dB
Leakage Current at 25°C	Acquisition phase		1		nA
Input Impedance		See the Analog Input section.			
THROUGHPUT SPEED					
Complete Cycle				10	μS
Throughput Rate		0		100	kSPS
DCLOCK Frequency		0		2.9	MHz
REFERENCE					
Voltage Range		0.5		VDD + 0.3	V
Load Current	100 kSPS, V <sub>+IN</sub> – V <sub>–IN</sub> = V <sub>REF</sub> /2 = 2.5 V		50		μA
DIGITAL INPUTS					
Logic Levels					
V <sub>IL</sub>		–0.3		0.3 × VDD	V
V <sub>IH</sub>		0.7 × VDD		VDD + 0.3	V
I <sub>IL</sub>		–1		+1	μA
I <sub>IH</sub>		–1		+1	μA
Input Capacitance			5		pF
DIGITAL OUTPUTS					
Data Format		Serial, 16 bits straight binary.			
V <sub>OH</sub>	I <sub>SOURCE</sub> = –500 μA	VDD – 0.3			V
V <sub>OL</sub>	I <sub>SINK</sub> = +500 μA			0.4	V
POWER SUPPLIES					
VDD	Specified performance	2.7		5.5	V
VDD Range <sup>1</sup>		2.0		5.5	V
Operating Current	100 kSPS throughput				
VDD	VDD = 5 V		800		μA
	VDD = 2.7 V		560		μA
Standby Current <sup>2,3</sup>	VDD = 5 V, 25°C		1	50	nA
Power Dissipation	VDD = 5 V		4	6	mW
	VDD = 2.7 V		1.5		mW
	VDD = 2.7 V, 10 kSPS throughput		150		μW
TEMPERATURE RANGE					
Specified Performance	T <sub>MIN</sub> to T <sub>MAX</sub>	–40		+85	°C

<sup>1</sup> See the Typical Performance Characteristics section for more information.

<sup>2</sup> With all digital inputs forced to VDD or GND, as required.

<sup>3</sup> During acquisition phase.

# AD7683

VDD = 5 V; V<sub>REF</sub> = VDD; T<sub>A</sub> = -40°C to +85°C, unless otherwise noted.

**Table 3.**

Parameter	Conditions	A Grade			B Grade			Unit
		Min	Typ	Max	Min	Typ	Max	
<b>ACCURACY</b>								
No Missing Codes		15			16			Bits
Integral Linearity Error		-6	±3	+6	-3	±1	+3	LSB
Transition Noise			0.5			0.5		LSB
Gain Error <sup>1</sup> , T <sub>MIN</sub> to T <sub>MAX</sub>			±2	±24		±2	±15	LSB
Gain Error Temperature Drift			±0.3			±0.3		ppm/°C
Offset Error, T <sub>MIN</sub> to T <sub>MAX</sub>			±0.7	±1.6		±0.4	±1.6	mV
Offset Temperature Drift			±0.3			±0.3		ppm/°C
Power Supply Sensitivity	VDD = 5 V ±5%		±0.05			±0.05		LSB
<b>AC ACCURACY</b>								
Signal-to-Noise	f <sub>IN</sub> = 1 kHz		90		88	91		dB <sup>2</sup>
Spurious-Free Dynamic Range	f <sub>IN</sub> = 1 kHz		-100			-108		dB
Total Harmonic Distortion	f <sub>IN</sub> = 1 kHz		-100			-106		dB
Signal-to-(Noise + Distortion)	f <sub>IN</sub> = 1 kHz		90		88	91		dB
Effective Number of Bits	f <sub>IN</sub> = 1 kHz		14.7			14.8		Bits

<sup>1</sup> See the Terminology section. These specifications include full temperature range variation, but do not include the error contribution from the external reference.

<sup>2</sup> All specifications in dB are referred to a full-scale input, FS. Tested with an input signal at 0.5 dB below full scale, unless otherwise specified.

VDD = 2.7 V; V<sub>REF</sub> = 2.5V; T<sub>A</sub> = -40°C to +85°C, unless otherwise noted.

**Table 4.**

Parameter	Conditions	A Grade			B Grade			Unit
		Min	Typ	Max	Min	Typ	Max	
<b>ACCURACY</b>								
No Missing Codes		15			16			Bits
Integral Linearity Error		-6	±3	+6	-3	±1	+3	LSB
Transition Noise			0.85			0.85		LSB
Gain Error <sup>1</sup> , T <sub>MIN</sub> to T <sub>MAX</sub>			±2	±30		±2	±15	LSB
Gain Error Temperature Drift			±0.3			±0.3		ppm/°C
Offset Error, T <sub>MIN</sub> to T <sub>MAX</sub>			±0.7	±3.5		±0.7	±3.5	mV
Offset Temperature Drift			±0.3			±0.3		ppm/°C
Power Supply Sensitivity	VDD = 2.7 V ±5%		±0.05			±0.05		LSB
<b>AC ACCURACY</b>								
Signal-to-Noise	f <sub>IN</sub> = 1 kHz		85			86		dB <sup>2</sup>
Spurious-Free Dynamic Range	f <sub>IN</sub> = 1 kHz		-96			-100		dB
Total Harmonic Distortion	f <sub>IN</sub> = 1 kHz		-94			-98		dB
Signal-to-(Noise + Distortion)	f <sub>IN</sub> = 1 kHz		85			86		dB
Effective Number of Bits	f <sub>IN</sub> = 1 kHz		13.8			14		Bits

<sup>1</sup> See the Terminology section. These specifications do include full temperature range variation, but do not include the error contribution from the external reference.

<sup>2</sup> All specifications in dB are referred to a full-scale input FS. Tested with an input signal at 0.5 dB below full scale, unless otherwise specified.

## TIMING SPECIFICATIONS

VDD = 2.7 V to 5.5 V; T<sub>A</sub> = -40°C to +85°C, unless otherwise noted.

Table 5.

Parameter	Symbol	Min	Typ	Max	Unit
Throughput Rate	t <sub>CYC</sub>			100	kHz
$\overline{\text{CS}}$ Falling to DCLOCK Low	t <sub>CSD</sub>			0	μs
$\overline{\text{CS}}$ Falling to DCLOCK Rising	t <sub>SUCS</sub>	20			ns
DCLOCK Falling to Data Remains Valid	t <sub>HDO</sub>	5	16		ns
$\overline{\text{CS}}$ Rising Edge to D <sub>OUT</sub> High Impedance	t <sub>DIS</sub>		14	100	ns
DCLOCK Falling to Data Valid	t <sub>EN</sub>		16	50	ns
Acquisition Time	t <sub>ACQ</sub>	400			ns
D <sub>OUT</sub> Fall Time	t <sub>F</sub>		11	25	ns
D <sub>OUT</sub> Rise Time	t <sub>R</sub>		11	25	ns

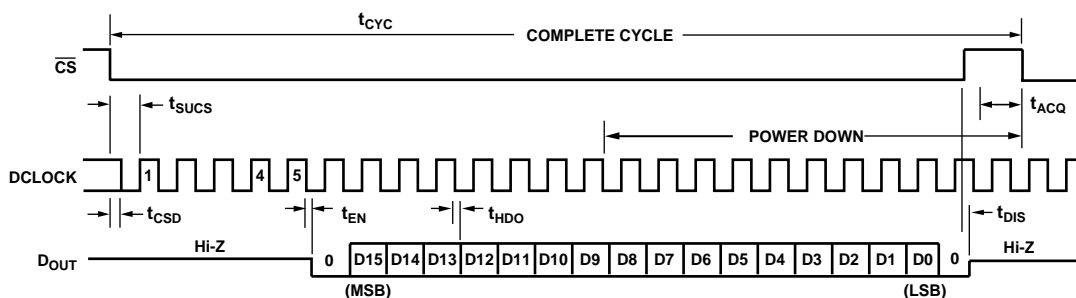

NOTE:  
A MINIMUM OF 22 CLOCK CYCLES ARE REQUIRED FOR 16-BIT CONVERSION. SHOWN ARE 24 CLOCK CYCLES.  
D<sub>OUT</sub> GOES LOW ON THE DCLOCK FALLING EDGE FOLLOWING THE LSB READING.

043301-002

Figure 2. Serial Interface Timing

## ABSOLUTE MAXIMUM RATINGS

Table 6.

Parameter	Rating
Analog Inputs +IN <sup>1</sup> , -IN <sup>1</sup>	GND – 0.3 V to VDD + 0.3 V or ±130 mA
REF	GND – 0.3 V to VDD + 0.3 V
Supply Voltages	
VDD to GND	–0.3 V to +6 V
Digital Inputs to GND	–0.3 V to VDD + 0.3 V
Digital Outputs to GND	–0.3 V to VDD + 0.3 V
Storage Temperature Range	–65°C to +150°C
Junction Temperature	150°C
θ <sub>JA</sub> Thermal Impedance	200°C/W (MSOP-8)
θ <sub>JC</sub> Thermal Impedance	44°C/W (MSOP-8)
Lead Temperature Range	
Vapor Phase (60 sec)	215°C
Infrared (15 sec)	220°C

Stresses above those listed under Absolute Maximum Ratings may cause permanent damage to the device. This is a stress rating only; functional operation of the device at these or any other conditions above those indicated in the operational section of this specification is not implied. Exposure to absolute maximum rating conditions for extended periods may affect device reliability.

<sup>1</sup> See the Analog Input section.

### ESD CAUTION

ESD (electrostatic discharge) sensitive device. Electrostatic charges as high as 4000 V readily accumulate on the human body and test equipment and can discharge without detection. Although this product features proprietary ESD protection circuitry, permanent damage may occur on devices subjected to high energy electrostatic discharges. Therefore, proper ESD precautions are recommended to avoid performance degradation or loss of functionality.

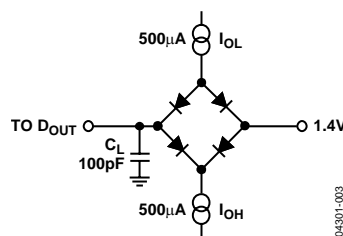

Figure 3. Load Circuit for Digital Interface Timing

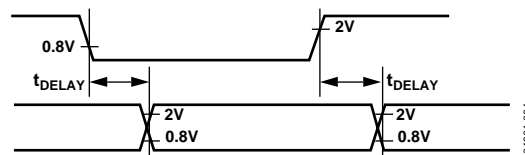

Figure 4. Voltage Reference Levels for Timing

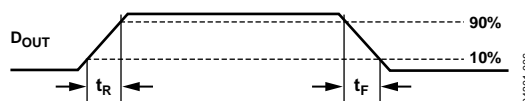

Figure 5. D<sub>OUT</sub> Rise and Fall Timing

## PIN CONFIGURATION AND FUNCTIONAL DESCRIPTIONS

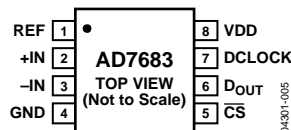

Figure 6. 8-Lead MSOP and QFN<sup>1</sup> (LFCSP) Pin Configuration

Table 7. Pin Function Descriptions

Pin No.	Mnemonic	Type <sup>2</sup>	Function
1	REF	AI	Reference Input Voltage. The REF range is from 0.5 V to VDD. It is referred to the GND pin. This pin should be decoupled closely to the pin with a ceramic capacitor of a few $\mu\text{F}$ .
2	+IN	AI	Analog Input. It is referred to in -IN. The voltage range, i.e., the difference between +IN and -IN, is 0 V to $V_{\text{REF}}$ .
3	-IN	AI	Analog Input Ground Sense. To be connected to the analog ground plane or to a remote sense ground.
4	GND	P	Power Supply Ground.
5	$\overline{\text{CS}}$	DI	Chip Select Input. On its falling edge, it initiates the conversions. The part returns in shutdown mode as soon as the conversion is done. It also enables $D_{\text{OUT}}$ . When high, $D_{\text{OUT}}$ is high impedance.
6	$D_{\text{OUT}}$	DO	Serial Data Output. The conversion result is output on this pin. It is synchronized to SCK.
7	DCLOCK	DI	Serial Data Clock Input.
8	VDD	P	Power Supply.

<sup>1</sup> QFN package in development. Contact factory for samples and availability.

<sup>2</sup> AI = Analog Input; DI = Digital Input; DO = Digital Output; and P = Power

## TERMINOLOGY

### Integral Nonlinearity Error (INL)

Linearity error refers to the deviation of each individual code from a line drawn from negative full scale through positive full scale. The point used as negative full scale occurs  $\frac{1}{2}$  LSB before the first code transition. Positive full scale is defined as a level  $1\frac{1}{2}$  LSB beyond the last code transition. The deviation is measured from the middle of each code to the true straight line (see Figure 21).

### Differential Nonlinearity Error (DNL)

In an ideal ADC, code transitions are 1 LSB apart. DNL is the maximum deviation from this ideal value. It is often specified in terms of resolution for which no missing codes are guaranteed.

### Offset Error

The first transition should occur at a level  $\frac{1}{2}$  LSB above analog ground (38.1  $\mu$ V for the 0 V to 5 V range). The offset error is the deviation of the actual transition from that point.

### Gain Error

The last transition (from 111...10 to 111...11) should occur for an analog voltage  $1\frac{1}{2}$  LSB below the nominal full scale (4.999886 V for the 0 V to 5 V range). The gain error is the deviation of the actual level of the last transition from the ideal level after the offset has been adjusted out.

### Spurious-Free Dynamic Range (SFDR)

The difference, in decibels (dB), between the rms amplitude of the input signal and the peak spurious signal.

### Effective Number of Bits (ENOB)

ENOB is a measurement of the resolution with a sine wave input. It is related to  $S/(N+D)$  by the following formula

$$ENOB = (S/[N + D]_{dB} - 1.76) / 6.02$$

and is expressed in bits.

### Total Harmonic Distortion (THD)

THD is the ratio of the rms sum of the first five harmonic components to the rms value of a full-scale input signal and is expressed in dB.

### Signal-to-Noise Ratio (SNR)

SNR is the ratio of the rms value of the actual input signal to the rms sum of all other spectral components below the Nyquist frequency, excluding harmonics and dc. The value for SNR is expressed in dB.

### Signal-to-(Noise + Distortion) Ratio (S/[N+D])

$S/(N+D)$  is the ratio of the rms value of the actual input signal to the rms sum of all other spectral components below the Nyquist frequency, including harmonics but excluding dc. The value for  $S/(N+D)$  is expressed in dB.

### Aperture Delay

Aperture delay is a measure of the acquisition performance and is the time between the falling edge of the  $\overline{CS}$  input and when the input signal is held for a conversion.

### Transient Response

The time required for the ADC to accurately acquire its input after a full-scale step function was applied.



# TYPICAL PERFORMANCE CHARACTERISTICS

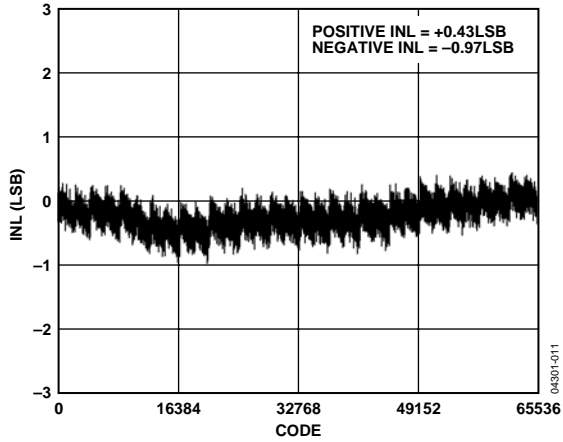

Figure 7. Integral Nonlinearity vs. Code

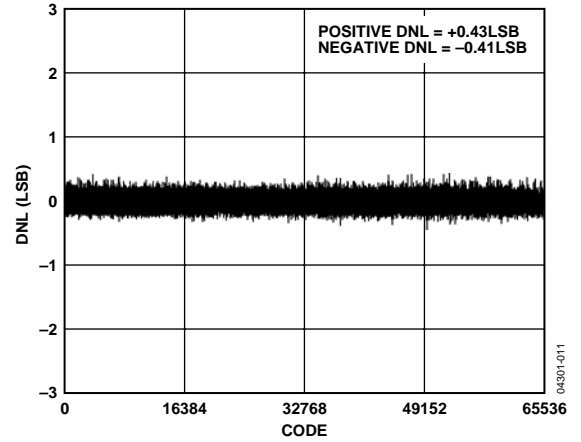

Figure 10. Differential Nonlinearity vs. Code

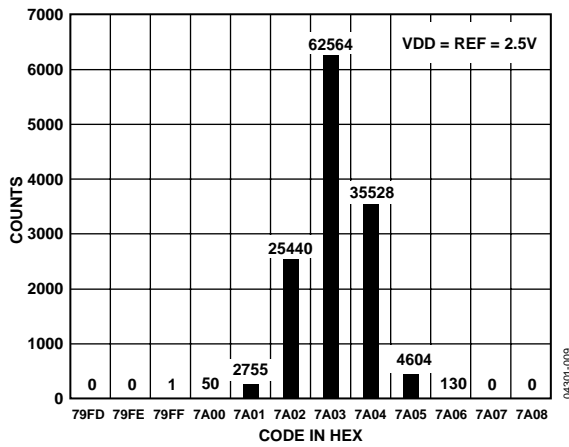

Figure 8. Histogram of a DC Input at the Code Center

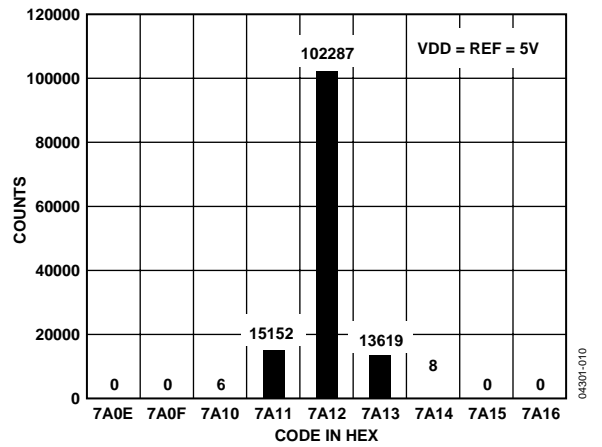

Figure 11. Histogram of a DC Input at the Code Center

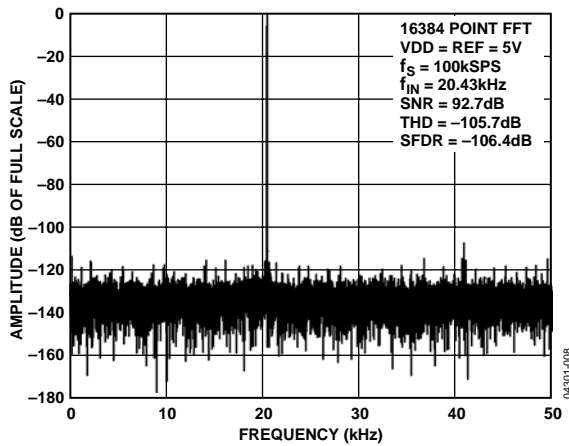

Figure 9. FFT Plot

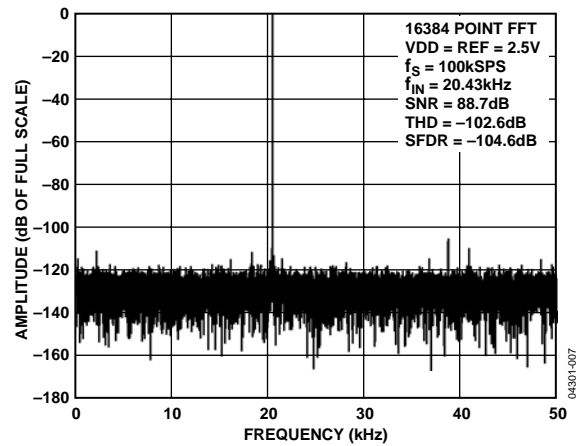

Figure 12. FFT Plot

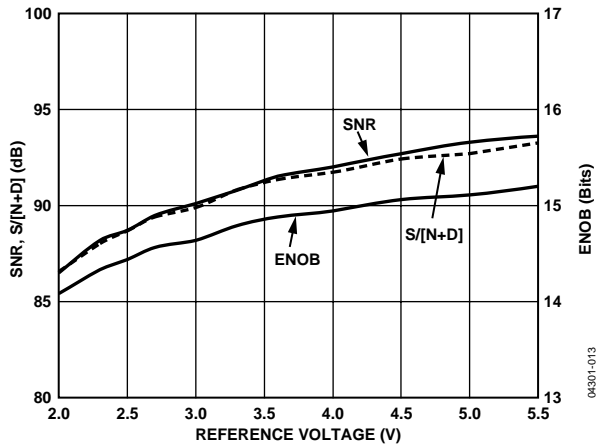

Figure 13. SNR,  $S/(N + D)$ , and ENOB vs. Reference Voltage

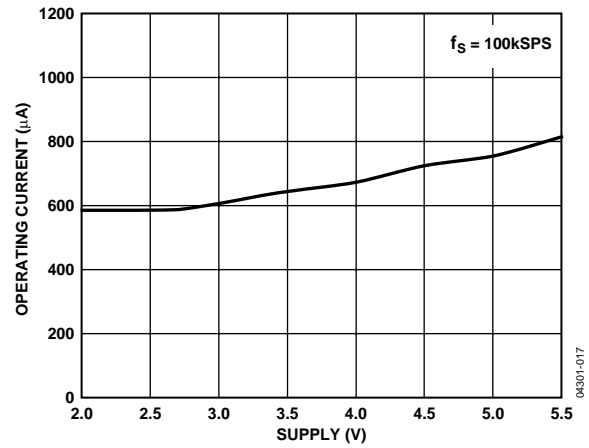

Figure 16. Operating Current vs. Supply

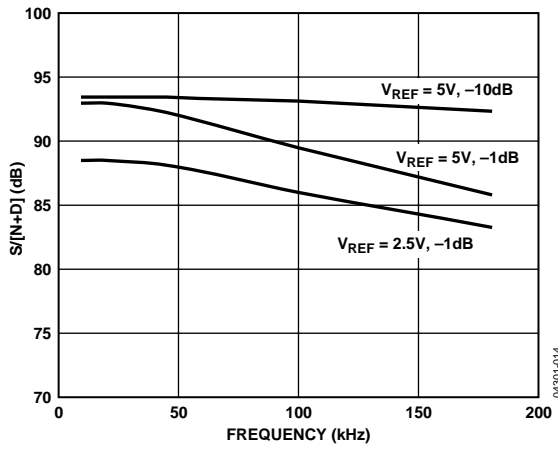

Figure 14.  $S/(N + D)$  vs. Frequency

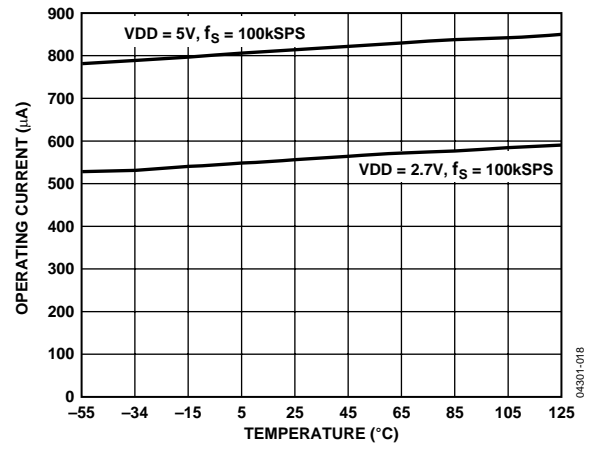

Figure 17. Operating Current vs. Temperature

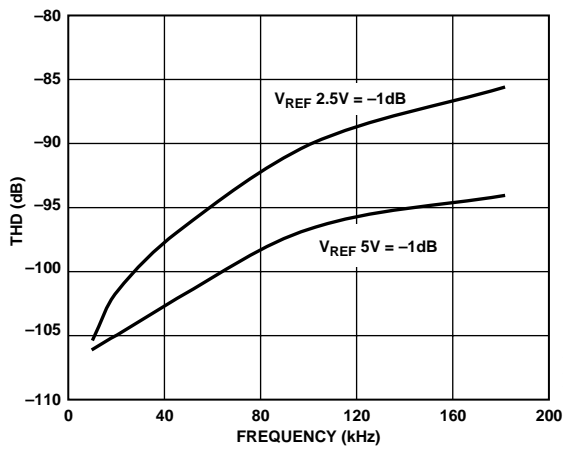

Figure 15. THD, ENOB vs. Frequency

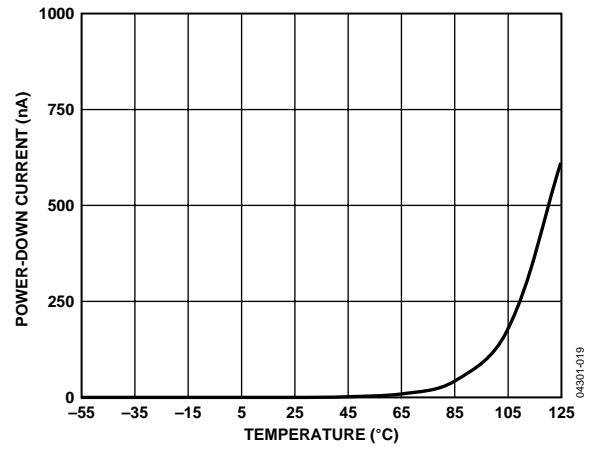

Figure 18. Power-Down Current vs. Temperature

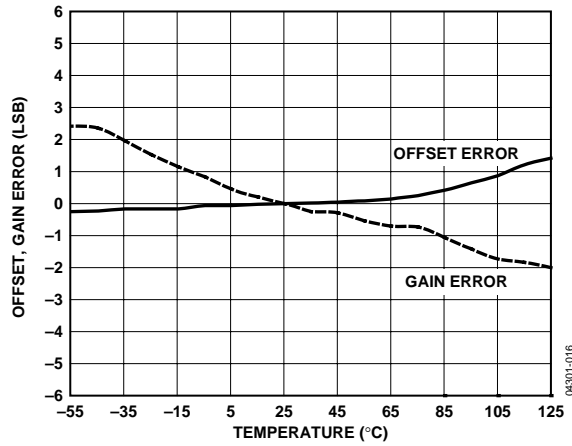

Figure 19. Offset and Gain Error vs. Temperature

## APPLICATION INFORMATION

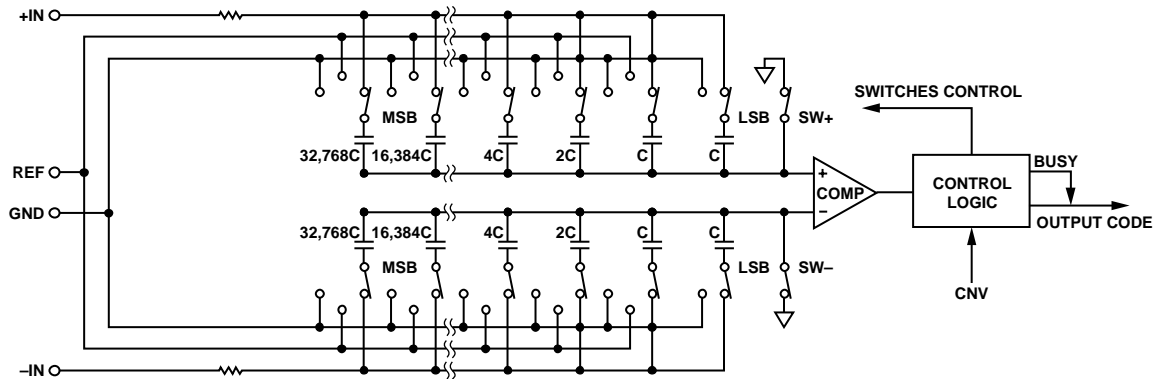

Figure 20. ADC Simplified Schematic

### CIRCUIT INFORMATION

The AD7683 is a low power, single-supply, 16-bit ADC using a successive approximation architecture.

The AD7683 is capable of converting 100,000 samples per second (100 kSPS) and powers down between conversions. When operating at 10 kSPS, for example, it consumes typically 150  $\mu$ W with a 2.7 V supply, ideal for battery-powered applications.

The AD7683 provides the user with an on-chip track-and-hold and does not exhibit any pipeline delay or latency, making it ideal for multiple, multiplexed channel applications.

The AD7683 is specified from 2.7 V to 5.5 V. It is housed in a 8-lead MSOP package or a tiny, 8-lead QFN (LFCSP) package.

The AD7683 is an improved second source to the ADS8320 and ADS8325. For even better performance, consider the [AD7685](#).

### CONVERTER OPERATION

The AD7683 is a successive approximation ADC based on a charge redistribution DAC. Figure 20 shows the simplified schematic of the ADC. The capacitive DAC consists of two identical arrays of 16 binary-weighted capacitors, which are connected to the two comparator inputs.

During the acquisition phase, terminals of the array tied to the comparator's input are connected to GND via SW+ and SW-. All independent switches are connected to the analog inputs. Thus, the capacitor arrays are used as sampling capacitors and acquire the analog signal on the +IN and -IN inputs. When the acquisition phase is complete and the  $\overline{CS}$  input goes low, a conversion phase is initiated. When the conversion phase begins, SW+ and SW- are opened first. The two capacitor arrays are then disconnected from the inputs and connected to the GND input. Therefore, the differential voltage between the inputs, +IN and -IN, captured at the end of the acquisition phase is applied to the comparator inputs, causing the comparator to become unbalanced. By switching each element of the capacitor

array between GND and REF, the comparator input varies by binary-weighted voltage steps ( $V_{REF}/2, V_{REF}/4, \dots, V_{REF}/65536$ ). The control logic toggles these switches, starting with the MSB, to bring the comparator back into a balanced condition. After the completion of this process, the part returns to the acquisition phase and the control logic generates the ADC output code.

### TRANSFER FUNCTIONS

The ideal transfer function for the AD7683 is shown in Figure 21 and Table 8.

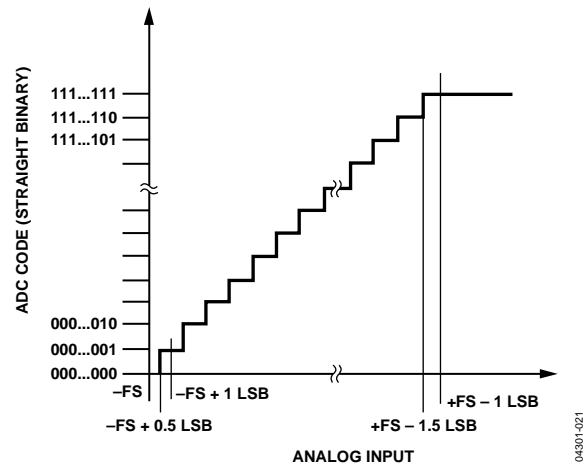

Figure 21. ADC Ideal Transfer Function

Table 8. Output Codes and Ideal Input Voltages

Description	Analog Input $V_{REF} = 5\text{ V}$	Digital Output Code Hexadecimal
FSR - 1 LSB	4.999924 V	FFFF <sup>1</sup>
Midscale + 1 LSB	2.500076 V	8001
Midscale	2.5 V	8000
Midscale - 1 LSB	2.499924 V	7FFF
-FSR + 1 LSB	76.3 $\mu$ V	0001
-FSR	0 V	0000 <sup>2</sup>

<sup>1</sup> This is also the code for an overranged analog input ( $V_{+IN} - V_{-IN}$  above  $V_{REF} - V_{GND}$ ).

<sup>2</sup> This is also the code for an underranged analog input ( $V_{+IN} - V_{-IN}$  below  $V_{GND}$ ).

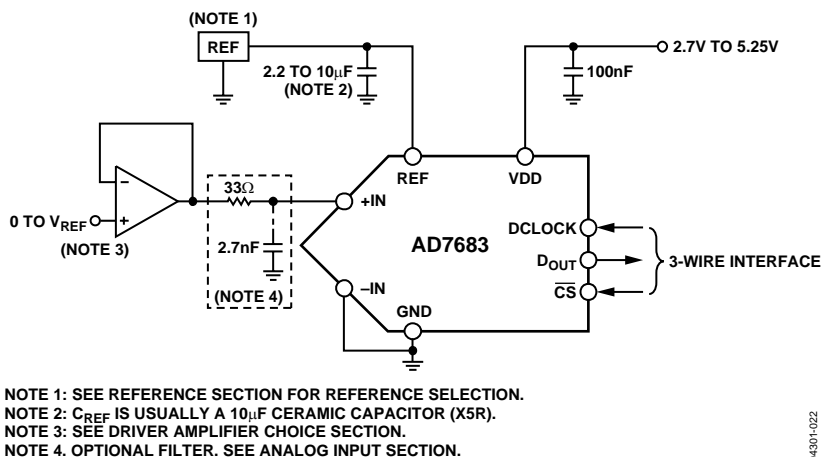

Figure 22. Typical Application Diagram

## TYPICAL CONNECTION DIAGRAM

Figure 22 shows an example of the recommended application diagram for the AD7683.

## ANALOG INPUT

Figure 23 shows an equivalent circuit of the input structure of the AD7683.

The two diodes, D1 and D2, provide ESD protection for the analog inputs, +IN and -IN. Care must be taken to ensure that the analog input signal never exceeds the supply rails by more than 0.3 V, because this will cause these diodes to become forward-biased and start conducting current. However, these diodes can handle a forward-biased current of 130 mA maximum. For instance, these conditions could eventually occur when the input buffer's (U1) supplies are different from VDD. In such a case, an input buffer with a short-circuit current limitation can be used to protect the part.

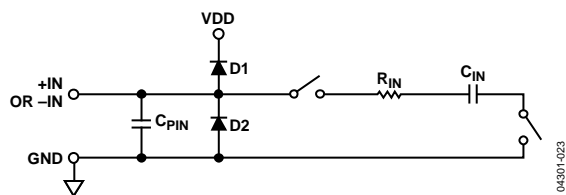

Figure 23. Equivalent Analog Input Circuit

This analog input structure allows the sampling of the differential signal between +IN and -IN. By using this differential input, small signals common to both inputs are rejected. For instance, by using -IN to sense a remote signal ground, ground potential differences between the sensor and the local ADC ground are eliminated. During the acquisition phase, the impedance of the analog input +IN can be modeled as a parallel combination of the capacitor  $C_{PIN}$  and the network formed by the series connection of  $R_{IN}$  and  $C_{IN}$ .  $C_{PIN}$  is primarily the pin capacitance.  $R_{IN}$  is typically 600  $\Omega$  and is a lumped component made up of some serial resistors and the on-resistance of the switches.  $C_{IN}$  is typically 30 pF and is mainly the ADC

sampling capacitor. During the conversion phase, where the switches are opened, the input impedance is limited to  $C_{PIN}$ .  $R_{IN}$  and  $C_{IN}$  make a 1-pole, low-pass filter that reduces undesirable aliasing effects and limits the noise.

When the source impedance of the driving circuit is low, the AD7683 can be driven directly. Large source impedances significantly affect the ac performance, especially THD. The dc performances are less sensitive to the input impedance.

## DRIVER AMPLIFIER CHOICE

Although the AD7683 is easy to drive, the driver amplifier needs to meet the following requirements:

- The noise generated by the driver amplifier needs to be kept as low as possible in order to preserve the SNR and transition noise performance of the AD7683. Note that the AD7683 has a noise much lower than most other 16-bit ADCs and, therefore, can be driven by a noisier op amp while preserving the same or better system performance. The noise coming from the driver is filtered by the AD7683 analog input circuit 1-pole, low-pass filter made by  $R_{IN}$  and  $C_{IN}$  or by the external filter, if one is used.
- For ac applications, the driver needs to have a THD performance suitable to that of the AD7683. Figure 15 shows the THD versus frequency that the driver should exceed.
- For multichannel multiplexed applications, the driver amplifier and the AD7683 analog input circuit must be able to settle for a full-scale step of the capacitor array at a 16-bit level (0.0015%). In the amplifier's data sheet, settling at 0.1% to 0.01% is more commonly specified. This could differ significantly from the settling time at a 16-bit level and should be verified prior to driver selection.

# AD7683

**Table 9. Recommended Driver Amplifiers**

Amplifier	Typical Application
AD8021	Very low noise and high frequency
AD8022	Low noise and high frequency
OP184	Low power, low noise, and low frequency
AD8605, AD8615	5 V single-supply, low power
AD8519	Small, low power, and low frequency
AD8031	High frequency and low power

## VOLTAGE REFERENCE INPUT

The AD7683 voltage reference input, REF, has a dynamic input impedance. It should therefore be driven by a low impedance source with efficient decoupling between the REF and GND pins, as explained in the Layout section.

When REF is driven by a very low impedance source (e.g., an unbuffered reference voltage like the low temperature drift [ADR43x](#) reference or a reference buffer using the [AD8031](#) or the [AD8605](#)), a 10  $\mu\text{F}$  (X5R, 0805 size) ceramic chip capacitor is appropriate for optimum performance.

If desired, smaller reference decoupling capacitor values down to 2.2  $\mu\text{F}$  can be used with a minimal impact on performance, especially DNL.

## POWER SUPPLY

The AD7683 powers down automatically at the end of each conversion phase and, therefore, the power scales linearly with the sampling rate, as shown in Figure 24. This makes the part ideal for low sampling rates (even of a few Hz) and low battery-powered applications.

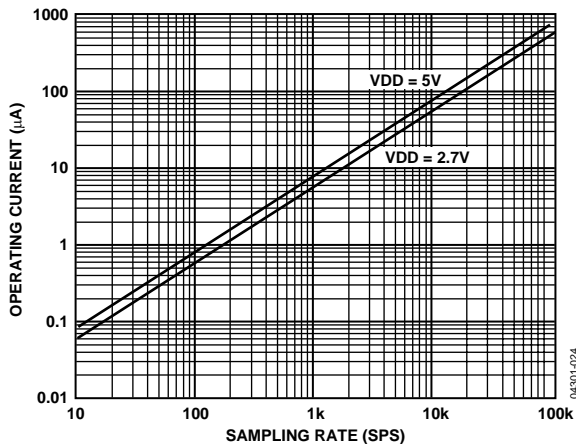

Figure 24. Operating Current vs. Sampling Rate

## DIGITAL INTERFACE

The AD7683 is compatible with SPI, QSPI, digital hosts, and DSPs (e.g., Blackfin® ADSP-BF53x or ADSP-219x). The connection diagram is shown in Figure 25 and the corresponding timing is given in Figure 2.

A falling edge on  $\overline{\text{CS}}$  initiates a conversion and the data transfer. After the fifth DCLOCK falling edge,  $\text{D}_{\text{OUT}}$  is enabled and forced low. The data bits are then clocked, MSB first, by subsequent DCLOCK falling edges. The data is valid on both SCK edges. Although the rising edge can be used to capture the data, a digital host also using the SCK falling edge allows a faster reading rate, provided it has an acceptable hold time.

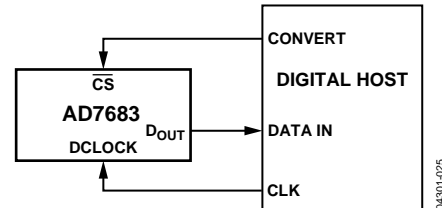

Figure 25. Connection Diagram

## LAYOUT

The printed circuit board housing the AD7683 should be designed so that the analog and digital sections are separated and confined to certain areas of the board. The pinout of the AD7683 with all its analog signals on the left side and all its digital signals on the right side eases this task.

Avoid running digital lines under the device because these couple noise onto the die, unless a ground plane under the AD7683 is used as a shield. Fast switching signals, such as  $\overline{\text{CS}}$  or clocks, should never run near analog signal paths. Crossover of digital and analog signals should be avoided.

At least one ground plane should be used. It could be common or split between the digital and analog section. In such a case, it should be joined underneath the AD7683.

The AD7683 voltage reference input REF has a dynamic input impedance and should be decoupled with minimal parasitic inductances. That is done by placing the reference decoupling ceramic capacitor close to, and ideally right up against, the REF and GND pins and by connecting these pins with wide, low impedance traces.

Finally, the power supply, VDD, of the AD7683 should be decoupled with a ceramic capacitor, typically 100 nF, and placed close to the AD7683. It should be connected using short and large traces to provide low impedance paths and reduce the effect of glitches on the power supply lines.

## EVALUATING THE AD7683'S PERFORMANCE

Other recommended layouts for the AD7683 are outlined in the evaluation board for the AD7683 ([EVAL-AD7683](#)). The evaluation board package includes a fully assembled and tested evaluation board, documentation, and software for controlling the board from a PC via the [EVAL-CONTROL BRD2](#).

## OUTLINE DIMENSIONS

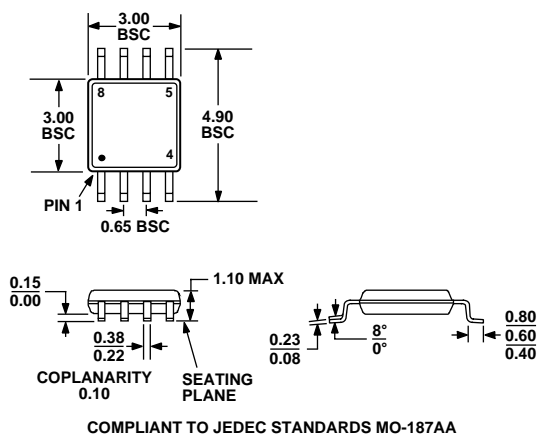

Figure 26. 8-Lead Micro Small Outline Package [MSOP]  
(RM-8)  
Dimensions Shown in Millimeters

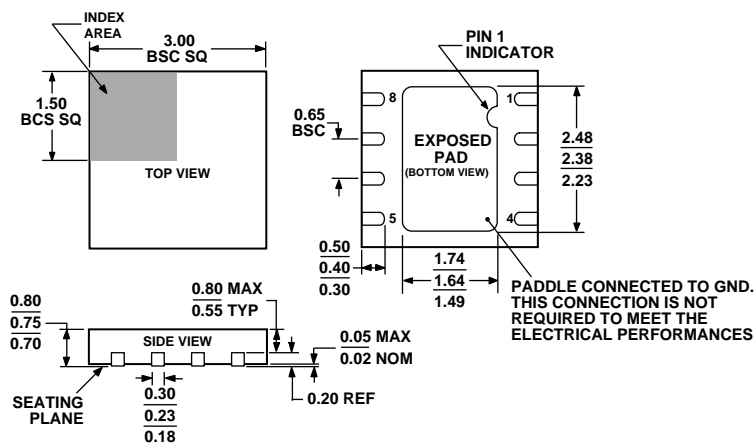

Figure 27. 8-Terminal Quad Flat No Lead Package [QFN<sup>1</sup> (LFCSP)]  
3 mm × 3 mm Body  
(CP-8-9)  
Dimensions Shown in Millimeters

## ORDERING GUIDE

Models	Integral Nonlinearity	Temperature Range	Package (Option)	Transport Media, Quantity	Branding
AD7683ARM	±6 LSB max	-40°C to +85°C	MSOP (RM-8)	Tube, 50	C1L
AD7683ARMRL7	±6 LSB max	-40°C to +85°C	MSOP (RM-8)	Reel, 1,000	C1L
AD7683BRM	±3 LSB max	-40°C to +85°C	MSOP (RM-8)	Tube, 50	C1C
AD7683BRMRL7	±3 LSB max	-40°C to +85°C	MSOP (RM-8)	Reel, 1,000	C1C
EVAL-AD7683CB <sup>2</sup>			Evaluation Board		
EVAL-CONTROL BRD2 <sup>3</sup>			Controller Board		
EVAL-CONTROL BRD3 <sup>3</sup>			Controller Board		

<sup>1</sup> QFN package in development. Contact factory for samples and availability.

<sup>2</sup> This board can be used as a standalone evaluation board or in conjunction with the EVAL-CONTROL BRDx for evaluation/demonstration purposes.

<sup>3</sup> These boards allow a PC to control and communicate with all Analog Devices' evaluation boards ending in the CB designators.

**AD7683**

**NOTES**