

Features

- Glass Passivated Die Construction
- Low Forward Voltage Drop, High Current Capability
- Surge Overload Rating to 50A Peak
- Designed for Printed Circuit Board Applications
- UL Listed Under Recognized Component Index, File Number E94661
- **Lead Free Finish, RoHS Compliant (Date Code 0532+)** (Note 3)

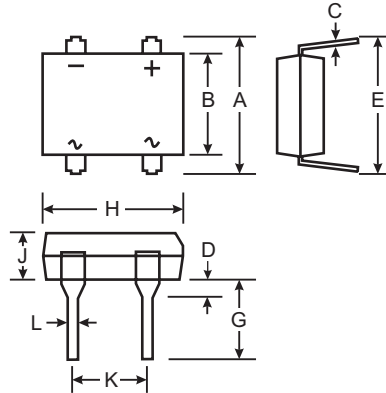

| DF-M | | |
|----------------------|------|------|
| Dim | Min | Max |
| A | 7.40 | 7.90 |
| B | 6.20 | 6.50 |
| C | 0.22 | 0.30 |
| D | 1.27 | 2.03 |
| E | 7.60 | 8.90 |
| G | 3.81 | 4.69 |
| H | 8.13 | 8.51 |
| J | 2.40 | 2.60 |
| K | 5.00 | 5.20 |
| L | 0.46 | 0.58 |
| M | 1.40 | 1.56 |
| N | 2.10 | 2.34 |
| All Dimensions in mm | | |

Mechanical Data

- Case: DF-M
- Case Material: Molded Plastic. UL Flammability Classification Rating 94V-0
- Moisture Sensitivity: Level 1 per J-STD-020C
- Terminals: Finish - Tin. Solder Plated Leads, Solderable per MIL-STD-202, Method 208 (e3)
- Polarity: As Marked on Case
- Marking: Type Number, See Page 3
- Weight: 0.38 grams (approximate)

Maximum Ratings and Electrical Characteristics @ T_A = 25°C unless otherwise specified

Single phase, 60Hz, resistive or inductive load.
For capacitive load, derate current by 20%.

| Characteristic | Symbol | DF 005M | DF 01M | DF 02M | DF 04M | DF 06M | DF 08M | DF 10M | Unit |
|--|--|-------------|--------|--------|--------|--------|--------|--------|------------------|
| Peak Repetitive Reverse Voltage Working Peak Reverse Voltage DC Blocking Voltage | V _{RMM} V _{RWM} V _R | 50 | 100 | 200 | 400 | 600 | 800 | 1000 | V |
| RMS Reverse Voltage | V _{RMS} | 35 | 70 | 140 | 280 | 420 | 580 | 700 | V |
| Average Rectified Output Current @ T _A = 40°C | I _O | 1.0 | | | | | | | A |
| Non-Repetitive Peak Forward Surge Current, 8.3 ms single half-sine-wave superimposed on rated load | I _{FSM} | 50 | | | | | | | A |
| Forward Voltage (per element) @ I _F = 1.0 A | V _{FM} | 1.1 | | | | | | | V |
| Peak Reverse Current @ T _A = 25°C at Rated DC Blocking Voltage (per element) @ T _A = 125°C | I _{RM} | 10 500 | | | | | | | μA |
| I ² t Rating for Fusing (t<8.3ms) | I ² t | 10.4 | | | | | | | A ² s |
| Typical Total Capacitance per element (Note 1) | C _T | 25 | | | | | | | pF |
| Typical Thermal Resistance, Junction to Ambient (Note 2) | R _{θJA} | 40 | | | | | | | °C/W |
| Operating and Storage Temperature Range | T _j , T _{STG} | -65 to +150 | | | | | | | °C |

- Notes: 1. Measured at 1.0MHz and Applied Reverse Voltage of 4.0V DC.
2. Thermal Resistance, junction to ambient, measured on PC board with 5.0²mm (0.03mm thick) land areas.
3. RoHS revision 13.2.2003. Glass and High Temperature Solder Exemptions Applied, see EU Directive Annex Notes 5 and 7.

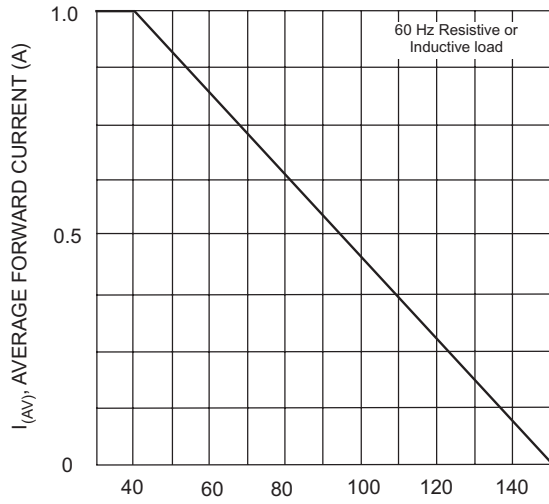

T_A , AMBIENT TEMPERATURE (°C)
Fig. 1 Output Current Derating Curve

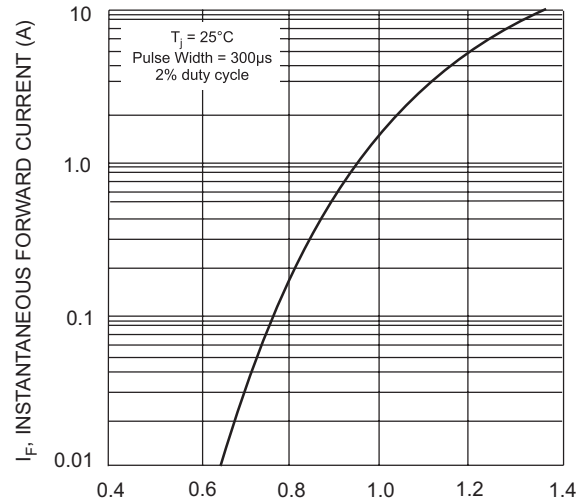

V_F , INSTANTANEOUS FORWARD VOLTAGE (V)
Fig. 2 Typ Forward Characteristics (per element)

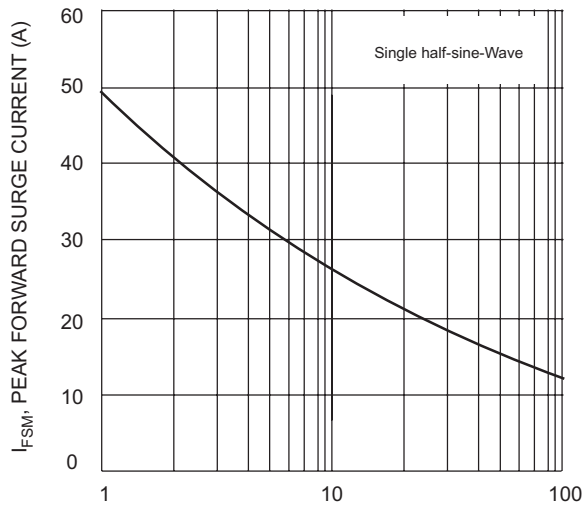

NUMBER OF CYCLES AT 60 Hz
Fig. 3 Max Non-Repetitive Peak Forward Surge Current

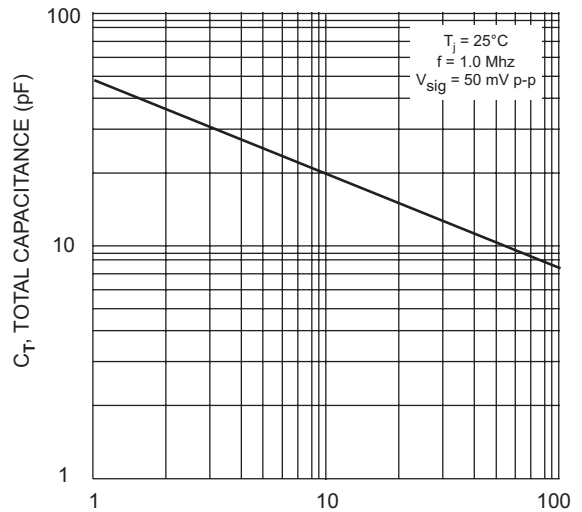

V_R , REVERSE VOLTAGE (V)
Fig. 4 Typical Total Capacitance (per element)

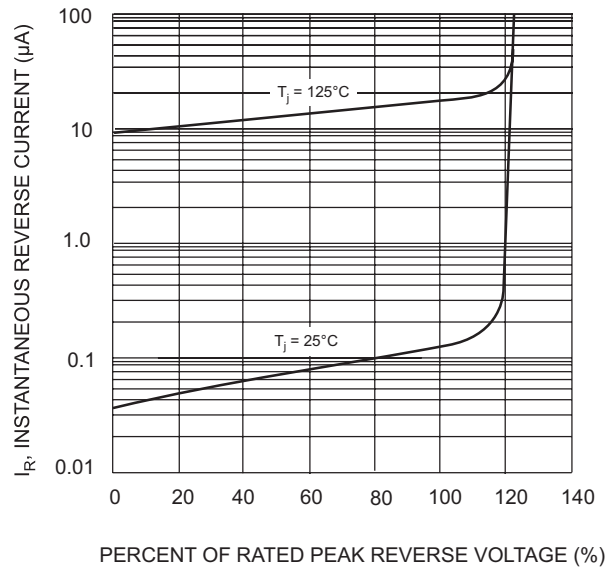

PERCENT OF RATED PEAK REVERSE VOLTAGE (%)
Fig. 5 Typ Reverse Characteristics (per element)

Ordering Information (Note 4)

| Device* | Packaging | Shipping |
|----------------|--------------|-----------------------------------|
| DFxM DFxM-T | DF-M DF-M | Tube 1500/Tape & Reel, 13-inch |

* x = Device type, e.g. DF005S or DF10S, etc.

Notes: 4. For Packaging Details, go to our website at <http://www.diodes.com/datasheets/ap02007.pdf>.

Marking Information

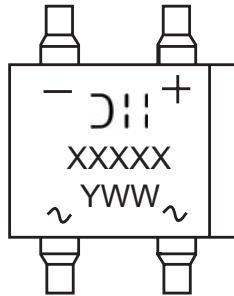

D||| = Manufacturers' code marking
 XXXXX = Product type marking code, ex: DF10M
 YWW = Date code marking
 Y = Last digit of year ex: 2 for 2002
 WW = Week code 01 to 52

IMPORTANT NOTICE

Diodes Incorporated and its subsidiaries reserve the right to make modifications, enhancements, improvements, corrections or other changes without further notice to any product herein. Diodes Incorporated does not assume any liability arising out of the application or use of any product described herein; neither does it convey any license under its patent rights, nor the rights of others. The user of products in such applications shall assume all risks of such use and will agree to hold Diodes Incorporated and all the companies whose products are represented on our website, harmless against all damages.

LIFE SUPPORT

Diodes Incorporated products are not authorized for use as critical components in life support devices or systems without the expressed written approval of the President of Diodes Incorporated.