



3.3V 1M x 18 Flowthrough Synchronous SRAM with NTD™

Features

- Organization: 1,048,576 words × 18 bits
- NTD™ architecture for efficient bus operation
- Fast clock to data access: 7.5/8.5/10 ns
- Fast \overline{OE} access time: 3.5/4.0 ns
- Fully synchronous operation
- Flow-through mode
- Asynchronous output enable control
- Available in 100-pin TQFP package
- Individual byte write and global write
- Clock enable for operation hold
- Multiple chip enables for easy expansion
- 3.3V core power supply
- 2.5V or 3.3V I/O operation with separate V_{DDQ}
- Self-timed write cycles
- Interleaved or linear burst modes
- Snooze mode for standby operation

Logic block diagram

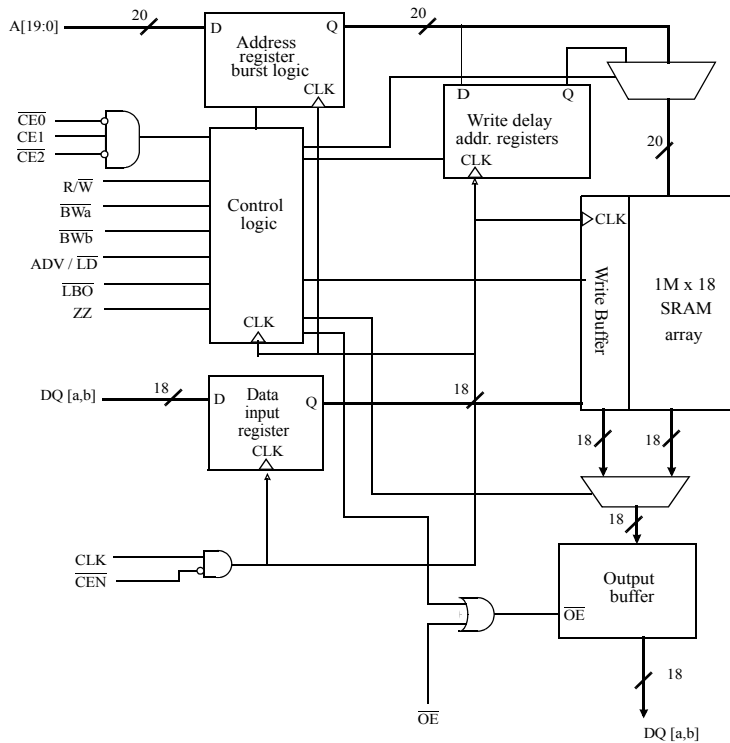

Selection guide

	-75	-85	-10	Units
Minimum cycle time	8.5	10	12	ns
Maximum clock access time	7.5	8.5	10	ns
Maximum operating current	275	250	230	mA
Maximum standby current	90	80	80	mA
Maximum CMOS standby current (DC)	60	60	60	mA



16 Mb Synchronous SRAM products list^{1,2}

Org	Part Number	Mode	Speed
1MX18	AS7C331MPFS18A	PL-SCD	166/133 MHz
512KX32	AS7C33512PFS32A	PL-SCD	166/133 MHz
512KX36	AS7C33512PFS36A	PL-SCD	166/133 MHz
1MX18	AS7C331MPFD18A	PL-DCD	166/133 MHz
512KX32	AS7C33512PFD32A	PL-DCD	166/133 MHz
512KX36	AS7C33512PFD36A	PL-DCD	166/133 MHz
1MX18	AS7C331MFT18A	FT	7.5/8.5/10 ns
512KX32	AS7C33512FT32A	FT	7.5/8.5/10 ns
512KX36	AS7C33512FT36A	FT	7.5/8.5/10 ns
1MX18	AS7C331MNTD18A	NTD-PL	166/133 MHz
512KX32	AS7C33512NTD32A	NTD-PL	166/133 MHz
512KX36	AS7C33512NTD36A	NTD-PL	166/133 MHz
1MX18	AS7C331MNTF18A	NTD-FT	7.5/8.5/10 ns
512KX32	AS7C33512NTF32A	NTD-FT	7.5/8.5/10 ns
512KX36	AS7C33512NTF36A	NTD-FT	7.5/8.5/10 ns

1 Core Power Supply: VDD = 3.3V ± 0.165V

2 I/O Supply Voltage: VDDQ = 3.3V ± 0.165V for 3.3V I/O

VDDQ = 2.5V ± 0.125V for 2.5V I/O

- PL-SCD : Pipelined Burst Synchronous SRAM - Single Cycle Deselect
 PL-DCD : Pipelined Burst Synchronous SRAM - Double Cycle Deselect
 FT : Flow-through Burst Synchronous SRAM
 NTD¹-PL : Pipelined Burst Synchronous SRAM with NTDTM
 NTD-FT : Flow-through Burst Synchronous SRAM with NTDTM

1. NTD: No Turnaround Delay. NTDTM is a trademark of Alliance Semiconductor Corporation. All trademarks mentioned in this document are the property of their respective owners.



100-pin TQFP - top view

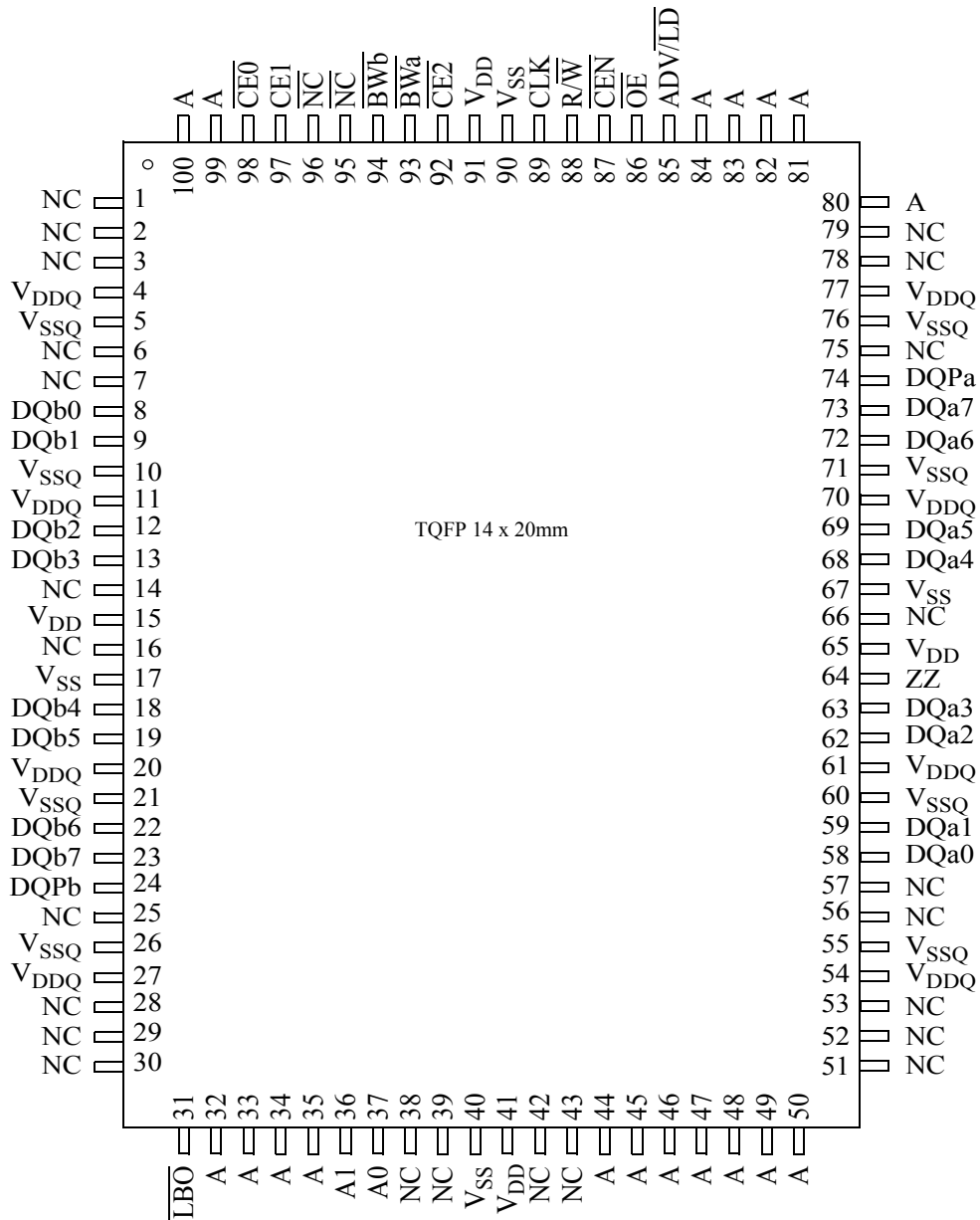



Functional Description

The AS7C331MNTF18A family is a high performance CMOS 16 Mbit synchronous Static Random Access Memory (SRAM) organized as 1,048,576 words \times 18 bits and incorporates a LATE Write.

This variation of the 16Mb+ synchronous SRAM uses the No Turnaround Delay (NTDTM) architecture, featuring an enhanced write operation that improves bandwidth over flowthrough burst devices. In a normal flowthrough burst device, the write data, command, and address are all applied to the device on the same clock edge. If a read command follows this write command, the system must wait for one 'dead' cycle for valid data to become available. This dead cycle can significantly reduce overall bandwidth for applications requiring random access or read-modify-write operations.

NTDTM devices use the memory bus more efficiently by introducing a write latency which matches the one-cycle flowthrough read latency. Write data is applied one cycle after the write command and address, allowing the read pipeline to clear. With NTDTM, write and read operations can be used in any order without producing dead bus cycle.

Assert $\overline{R/\overline{W}}$ low to perform write cycles. Byte write enable controls write access to specific bytes, or can be tied low for full 18 bit writes. Write enable signals, along with the write address, are registered on a rising edge of the clock. Write data is applied to the device one clock cycle later. Unlike some asynchronous SRAMs, output enable \overline{OE} does not need to be toggled for write operations; it can be tied low for normal operations. Outputs go to a high impedance state when the device is de-selected by any of the three chip enable inputs.

Use the ADV (burst advance) input to perform burst read, write and deselect operations. When ADV is high, external addresses, chip select, $\overline{R/\overline{W}}$ pins are ignored, and internal address counters increment in the count sequence specified by the \overline{LBO} control. Any device operations, including burst, can be stalled using the $\overline{CEN}=1$, the clock enable input.

The AS7C331MNTF18A operates with a $3.3V \pm 5\%$ power supply for the device core (V_{DD}). DQ circuits use a separate power supply (V_{DDQ}) that operates across 3.3V or 2.5V ranges. These devices are available in a 100-pin TQFP package.

TQFP capacitance

Parameter	Symbol	Test conditions	Min	Max	Unit
Input capacitance	C_{IN}^*	$V_{IN} = 0V$	-	5	pF
I/O capacitance	$C_{I/O}^*$	$V_{OUT} = 0V$	-	7	pF

* Guaranteed not tested

TQFP thermal resistance

Description	Conditions		Symbol	Typical	Units
Thermal resistance (junction to ambient) ¹	Test conditions follow standard test methods and procedures for measuring thermal impedance, per EIA/JESD51	1-layer	θ_{JA}	40	$^{\circ}C/W$
		4-layer	θ_{JA}	22	$^{\circ}C/W$
Thermal resistance (junction to top of case) ¹			θ_{JC}	8	$^{\circ}C/W$

¹ This parameter is sampled



Signal descriptions

Signal	I/O	Properties	Description
CLK	I	CLOCK	Clock. All inputs except \overline{OE} , \overline{LBO} , and ZZ are synchronous to this clock.
\overline{CEN}	I	SYNC	Clock enable. When de-asserted high, the clock input signal is masked.
A, A0, A1	I	SYNC	Address. Sampled when all chip enables are active and $\overline{ADV/LD}$ is asserted.
DQ[a,b]	I/O	SYNC	Data. Driven as output when the chip is enabled and \overline{OE} is active.
$\overline{CE0}$, CE1, CE2	I	SYNC	Synchronous chip enables. Sampled at the rising edge of CLK, when $\overline{ADV/LD}$ is asserted. Are ignored when $\overline{ADV/LD}$ is high.
$\overline{ADV/LD}$	I	SYNC	Advance or Load. When sampled high, the internal burst address counter will increment in the order defined by the \overline{LBO} input value. When low, a new address is loaded.
R/ \overline{W}	I	SYNC	A high during LOAD initiates a READ operation. A low during LOAD initiates a WRITE operation. Is ignored when $\overline{ADV/LD}$ is high.
$\overline{BW[a,b]}$	I	SYNC	Byte write enables. Used to control write on individual bytes. Sampled along with WRITE command and BURST WRITE.
\overline{OE}	I	ASYNC	Asynchronous output enable. I/O pins are not driven when \overline{OE} is inactive.
\overline{LBO}	I	STATIC	Selects Burst mode. When tied to V_{DD} or left floating, device follows interleaved Burst order. When driven Low, device follows linear Burst order. <i>This signal is internally pulled High.</i>
ZZ	I	ASYNC	Snooze. Places device in low power mode; data is retained. Connect to GND if unused.
NC	-	-	No connect

Snooze Mode

SNOOZE MODE is a low current, power-down mode in which the device is deselected and current is reduced to I_{SB2} . The duration of SNOOZE MODE is dictated by the length of time the ZZ is in a High state.

The ZZ pin is an asynchronous, active high input that causes the device to enter SNOOZE MODE.

When the ZZ pin becomes a logic High, I_{SB2} is guaranteed after the time t_{ZZI} is met. After entering SNOOZE MODE, all inputs except ZZ is disabled and all outputs go to High-Z. Any operation pending when entering SNOOZE MODE is not guaranteed to successfully complete. Therefore, SNOOZE MODE (READ or WRITE) must not be initiated until valid pending operations are completed. Similarly, when exiting SNOOZE MODE during t_{PUS} , only a DESELECT or READ cycle should be given while the SRAM is transitioning out of SNOOZE MODE.



Burst order

Interleaved burst order ($\overline{\text{LBO}} = 1$)					Linear burst order ($\overline{\text{LBO}} = 0$)				
	A1 A0	A1 A0	A1 A0	A1 A0		A1 A0	A1 A0	A1 A0	A1 A0
Starting address	0 0	0 1	1 0	1 1	Starting Address	0 0	0 1	1 0	1 1
First increment	0 1	0 0	1 1	1 0	First increment	0 1	1 0	1 1	0 0
Second increment	1 0	1 1	0 0	0 1	Second increment	1 0	1 1	0 0	0 1
Third increment	1 1	1 0	0 1	0 0	Third increment	1 1	0 0	0 1	1 0

Synchronous truth table^[5,6,7,8,9,11]

$\overline{\text{CE0}}$	CE1	$\overline{\text{CE2}}$	$\overline{\text{ADV/LD}}$	R/W	$\overline{\text{BWn}}$	$\overline{\text{OE}}$	$\overline{\text{CEN}}$	Address source	CLK	Operation	DQ	Notes
H	X	X	L	X	X	X	L	NA	L to H	DESELECT Cycle	High-Z	
X	X	H	L	X	X	X	L	NA	L to H	DESELECT Cycle	High-Z	
X	L	X	L	X	X	X	L	NA	L to H	DESELECT Cycle	High-Z	
X	X	X	H	X	X	X	L	NA	L to H	CONTINUE DESELECT Cycle	High-Z	1
L	H	L	L	H	X	L	L	External	L to H	READ Cycle (Begin Burst)	Q	
X	X	X	H	X	X	L	L	Next	L to H	READ Cycle (Continue Burst)	Q	1,10
L	H	L	L	H	X	H	L	External	L to H	NOP/DUMMY READ (Begin Burst)	High-Z	2
X	X	X	H	X	X	H	L	Next	L to H	DUMMY READ (Continue Burst)	High-Z	1,2,10
L	H	L	L	L	L	X	L	External	L to H	WRITE CYCLE (Begin Burst)	D	3
X	X	X	H	X	L	X	L	Next	L to H	WRITE CYCLE (Continue Burst)	D	1,3,10
L	H	L	L	L	H	X	L	External	L to H	NOP/WRITE ABORT (Begin Burst)	High-Z	2,3
X	X	X	H	X	H	X	L	Next	L to H	WRITE ABORT (Continue Burst)	High-Z	1,2,3,10
X	X	X	X	X	X	X	H	Current	L to H	INHIBIT CLOCK	-	4

Key: X = Don't Care, H = HIGH, L = LOW. $\overline{\text{BWn}} = \text{H}$ means all byte write signals ($\overline{\text{BWA}}$, $\overline{\text{BWB}}$) are HIGH. $\overline{\text{BWn}} = \text{L}$ means one or more byte write signals are LOW.

Notes:

- 1 CONTINUE BURST cycles, whether READ or WRITE, use the same control inputs. The type of cycle performed (READ or WRITE) is chosen in the initial BEGIN BURST cycle. A CONTINUE DESELECT cycle can only be entered if a DESELECT CYCLE is executed first.
- 2 DUMMY READ and WRITE ABORT cycles can be considered NOPs because the device performs no external operation. A WRITE ABORT means a WRITE command is given, but no operation is performed.
- 3 $\overline{\text{OE}}$ may be wired LOW to minimize the number of control signals to the SRAM. The device will automatically turn off the output drivers during a WRITE cycle. $\overline{\text{OE}}$ may be used when the bus turn-on and turn-off times do not meet an application's requirements.
- 4 If an INHIBIT CLOCK command occurs during a READ operation, the DQ bus will remain active (Low-Z). If it occurs during a WRITE cycle, the bus will remain in High-Z. No WRITE operations will be performed during the INHIBIT CLOCK cycle.
- 5 $\overline{\text{BWA}}$ enables WRITES to byte "a" (DQa pins); $\overline{\text{BWB}}$ enables WRITES to byte "b" (DQb pins).
- 6 All inputs except $\overline{\text{OE}}$ and ZZ must meet setup and hold times around the rising edge (LOW to HIGH) of CLK.
- 7 Wait states are inserted by setting $\overline{\text{CEN}}$ HIGH.
- 8 This device contains circuitry that will ensure that the outputs will be in High-Z during power-up.
- 9 The device incorporates a 2-bit burst counter. Address wraps to the initial address every fourth BURST CYCLE.
- 10 The address counter is incremented for all CONTINUE BURST cycles.
- 11 ZZ pin is always Low in this truth table.



Absolute maximum ratings

Parameter	Symbol	Min	Max	Unit
Power supply voltage relative to GND	V_{DD}, V_{DDQ}	-0.5	+4.6	V
Input voltage relative to GND (input pins)	V_{IN}	-0.5	$V_{DD} + 0.5$	V
Input voltage relative to GND (I/O pins)	V_{IN}	-0.5	$V_{DDQ} + 0.5$	V
Power dissipation	P_D	-	1.8	W
DC output current	I_{OUT}	-	20 mA	mA
Storage temperature	T_{stg}	-65	+150	°C
Temperature under bias	T_{bias}	-65	+135	°C

Note: Stresses greater than those listed in this table may cause permanent damage to the device. This is a stress rating only, and functional operation of the device at these or any other conditions outside those indicated in the operational sections of this specification is not implied. Exposure to absolute maximum rating conditions may affect reliability.

Recommended operating conditions at 3.3V I/O

Parameter	Symbol	Min	Nominal	Max	Unit
Supply voltage for inputs	V_{DD}	3.135	3.3	3.465	V
Supply voltage for I/O	V_{DDQ}	3.135	3.3	3.465	V
Ground supply	V_{SS}	0	0	0	V

Recommended operating conditions at 2.5V I/O

Parameter	Symbol	Min	Nominal	Max	Unit
Supply voltage for inputs	V_{DD}	3.135	3.3	3.465	V
Supply voltage for I/O	V_{DDQ}	2.375	2.5	2.625	V
Ground supply	V_{SS}	0	0	0	V



DC electrical characteristics for 3.3V I/O operation

Parameter	Sym	Conditions	Min	Max	Unit
Input leakage current [†]	$ I_{LI} $	$V_{DD} = \text{Max}, 0V \leq V_{IN} \leq V_{DD}$	-2	2	μA
Output leakage current	$ I_{LO} $	$OE \geq V_{IH}, V_{DD} = \text{Max}, 0V \leq V_{OUT} \leq V_{DDQ}$	-2	2	μA
Input high (logic 1) voltage	V_{IH}	Address and control pins	2*	$V_{DD}+0.3$	V
		I/O pins	2*	$V_{DDQ}+0.3$	
Input low (logic 0) voltage	V_{IL}	Address and control pins	-0.3**	0.8	V
		I/O pins	-0.5**	0.8	
Output high voltage	V_{OH}	$I_{OH} = -4 \text{ mA}, V_{DDQ} = 3.135\text{V}$	2.4	-	V
Output low voltage	V_{OL}	$I_{OL} = 8 \text{ mA}, V_{DDQ} = 3.465\text{V}$	-	0.4	V

DC electrical characteristics for 2.5V I/O operation

Parameter	Sym	Conditions	Min	Max	Unit
Input leakage current [†]	$ I_{LI} $	$V_{DD} = \text{Max}, 0V \leq V_{IN} \leq V_{DD}$	-2	2	μA
Output leakage current	$ I_{LO} $	$OE \geq V_{IH}, V_{DD} = \text{Max}, 0V \leq V_{OUT} \leq V_{DDQ}$	-2	2	μA
Input high (logic 1) voltage	V_{IH}	Address and control pins	1.7*	$V_{DD}+0.3$	V
		I/O pins	1.7*	$V_{DDQ}+0.3$	V
Input low (logic 0) voltage	V_{IL}	Address and control pins	-0.3**	0.7	V
		I/O pins	-0.3**	0.7	V
Output high voltage	V_{OH}	$I_{OH} = -4 \text{ mA}, V_{DDQ} = 2.375\text{V}$	1.7	-	V
Output low voltage	V_{OL}	$I_{OL} = 8 \text{ mA}, V_{DDQ} = 2.625\text{V}$	-	0.7	V

[†] LBO and ZZ pins have an internal pull-up or pull-down, and input leakage = $\pm 10 \mu\text{A}$.

* $V_{IH \text{ max}} < V_{DD} + 1.5\text{V}$ for pulse width less than $0.2 \times t_{CYC}$

** $V_{IL \text{ min}} = -1.5$ for pulse width less than $0.2 \times t_{CYC}$

I_{DD} operating conditions and maximum limits

Parameter	Sym	Conditions	-75	-85	-10	Unit
Operating power supply current ¹	I_{CC}	$\overline{CE0} \leq V_{IL}, CE1 \geq V_{IH}, \overline{CE2} \leq V_{IL}, f = f_{\text{Max}}, I_{OUT} = 0 \text{ mA}, ZZ \leq V_{IL}$	275	250	230	mA
Standby power supply current	I_{SB}	All $V_{IN} \leq 0.2\text{V}$ or $\geq V_{DD} - 0.2\text{V}$, Deselected, $f = f_{\text{Max}}, ZZ \leq V_{IL}$	90	80	80	
	I_{SB1}	Deselected, $f = 0, ZZ \leq 0.2\text{V}$, all $V_{IN} \leq 0.2\text{V}$ or $\geq V_{DD} - 0.2\text{V}$	60	60	60	
	I_{SB2}	Deselected, $f = f_{\text{Max}}, ZZ \geq V_{DD} - 0.2\text{V}$, all $V_{IN} \leq V_{IL}$ or $\geq V_{IH}$	50	50	50	

¹ I_{CC} given with no output loading. I_{CC} increases with faster cycle times and greater output loading.



Timing characteristics over operating range

Parameter	Sym	-75		-85		-10		Unit	Notes ¹
		Min	Max	Min	Max	Min	Max		
Cycle time	t _{CYC}	8.5	–	10	–	12	–	ns	
Clock access time	t _{CD}	–	7.5	–	8.5	–	10	ns	
Output enable low to data valid	t _{OE}	–	3.5	–	4.0	–	4.0	ns	
Clock high to output low Z	t _{LZC}	2.5	–	2.5	–	2.5	–	ns	2,3,4
Data Output invalid from clock high	t _{OH}	3.0	–	3.0	–	3.0	–	ns	2
Output enable low to output low Z	t _{LZOE}	0	–	0	–	0	–	ns	2,3,4
Output enable high to output high Z	t _{HZOE}	–	3.5	–	4.0	–	4.0	ns	2,3,4
Clock high to output high Z	t _{HZC}	–	3.5	–	4.0	–	4.0	ns	2,3,4
Output enable high to invalid output	t _{OHOE}	0	–	0	–	0	–	ns	
Clock high pulse width	t _{CH}	2.5	–	3.0	–	4.0	–	ns	5
Clock low pulse width	t _{CL}	2.5	–	3.0	–	4.0	–	ns	5
Address and Control setup to clock high	t _{AS}	2.0	–	2.0	–	2.0	–	ns	6
Data setup to clock high	t _{DS}	2.0	–	2.0	–	2.0	–	ns	6
Write setup to clock high	t _{WS}	2.0	–	2.0	–	2.0	–	ns	6, 7
Chip select setup to clock high	t _{CSS}	2.0	–	2.0	–	2.0	–	ns	6, 8
Address hold from clock high	t _{AH}	0.5	–	0.5	–	0.5	–	ns	6
Data hold from clock high	t _{DH}	0.5	–	0.5	–	0.5	–	ns	6
Write hold from clock high	t _{WH}	0.5	–	0.5	–	0.5	–	ns	6, 7
Chip select hold from clock high	t _{CSH}	0.5	–	0.5	–	0.5	–	ns	6, 8
Clock enable setup to clock high	t _{CENS}	2.0	–	2.0	–	2.0	–	ns	6
Clock enable hold from clock high	t _{CENH}	0.5	–	0.5	–	0.5	–	ns	6
$\overline{\text{ADV}}$ setup to clock high	t _{ADVS}	2.0	–	2.0	–	2.0	–	ns	6
$\overline{\text{ADV}}$ hold from clock high	t _{ADVH}	0.5	–	0.5	–	0.5	–	ns	6

¹ See “Notes:” on page 15.

Snooze Mode Electrical Characteristics

Description	Conditions	Symbol	Min	Max	Units
Current during Snooze Mode	ZZ ≥ V _{IH}	I _{SB2}		50	mA
ZZ active to input ignored		t _{PDS}	2		cycle
ZZ inactive to input sampled		t _{PUS}	2		cycle
ZZ active to SNOOZE current		t _{ZZI}		2	cycle
ZZ inactive to exit SNOOZE current		t _{RZZI}	0		cycle



Key to switching waveforms

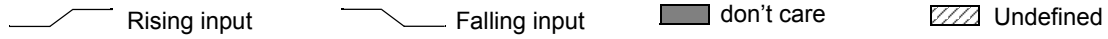

Timing waveform of read cycle

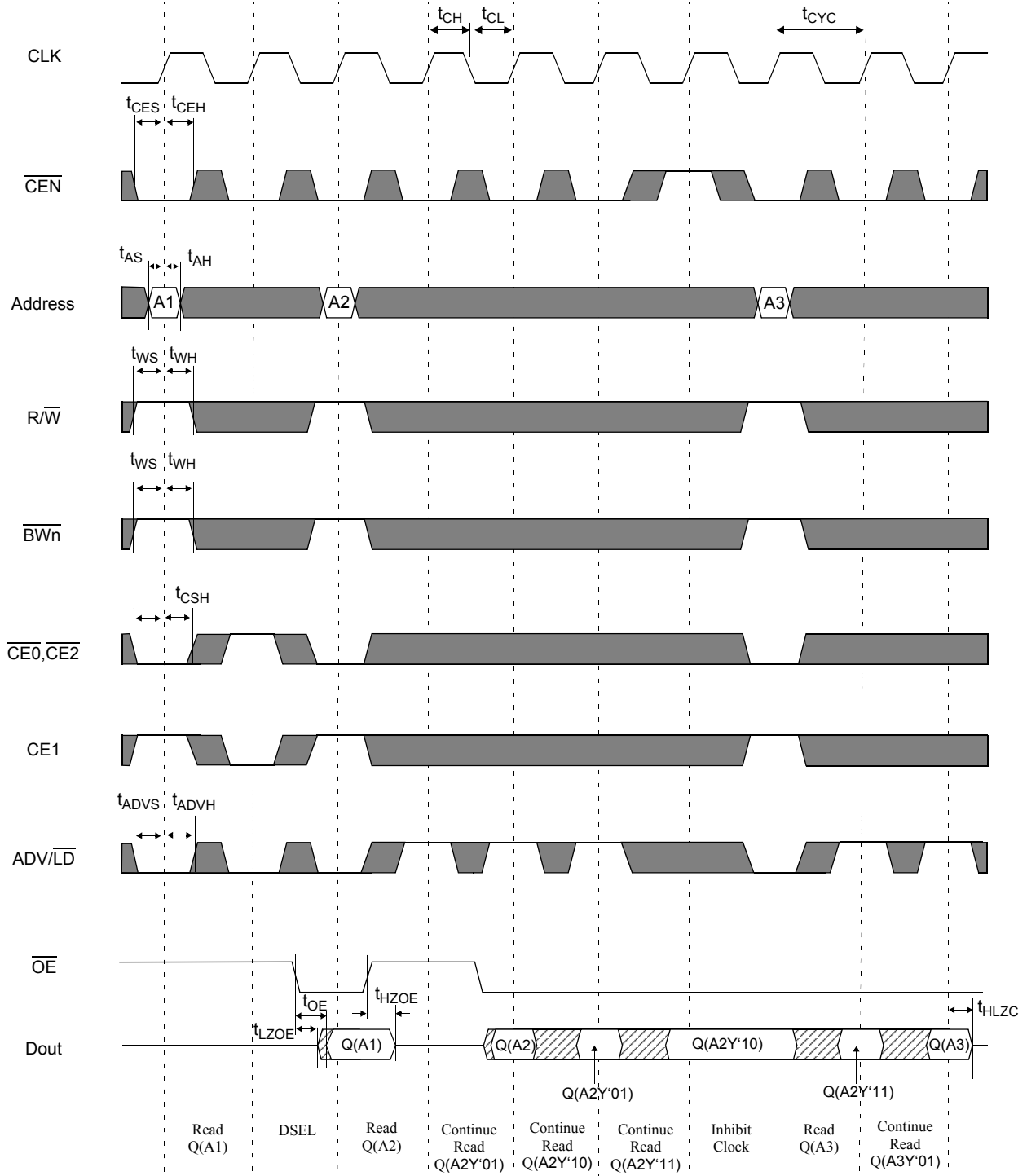



Timing waveform of write cycle

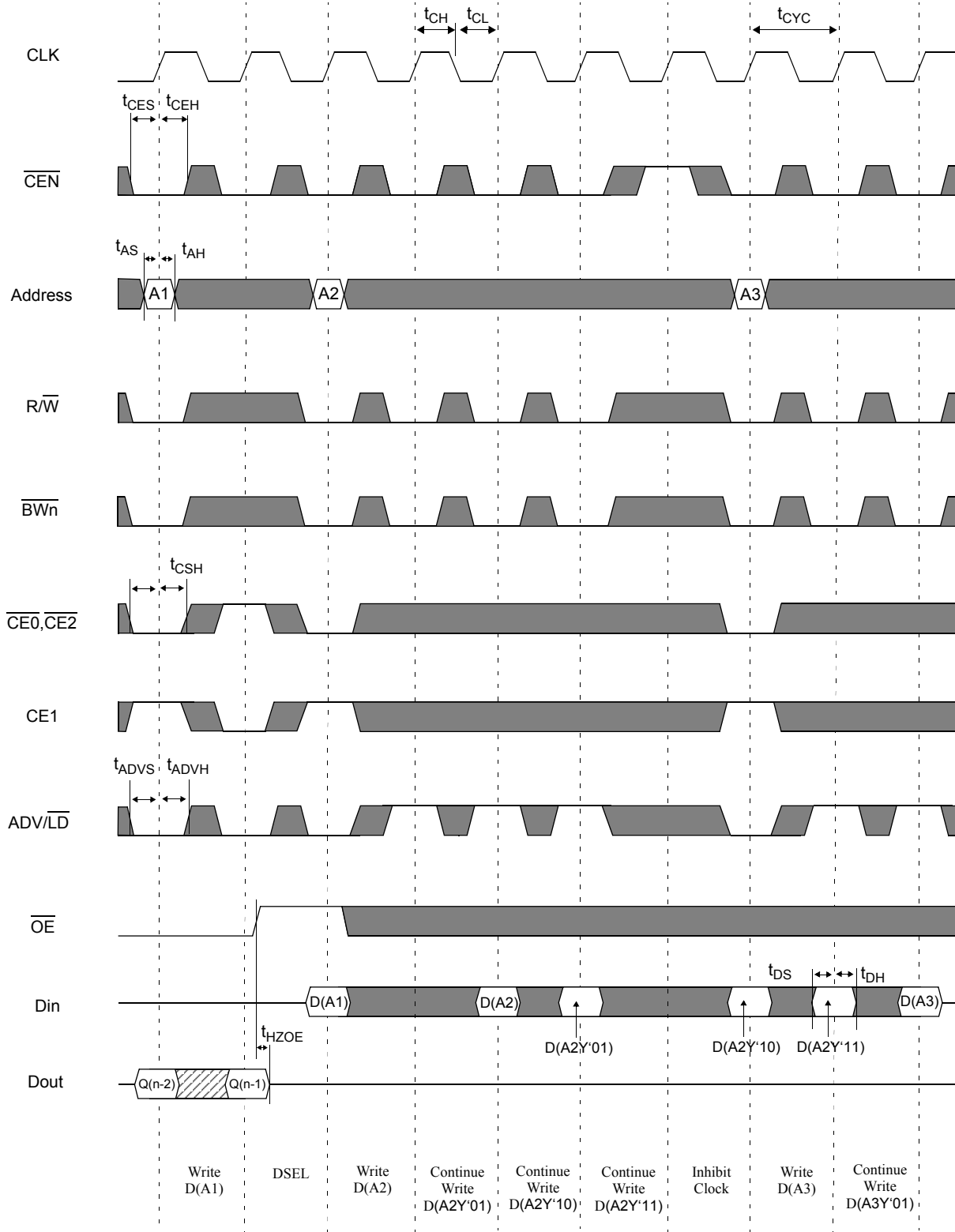



Timing waveform of read/write cycle

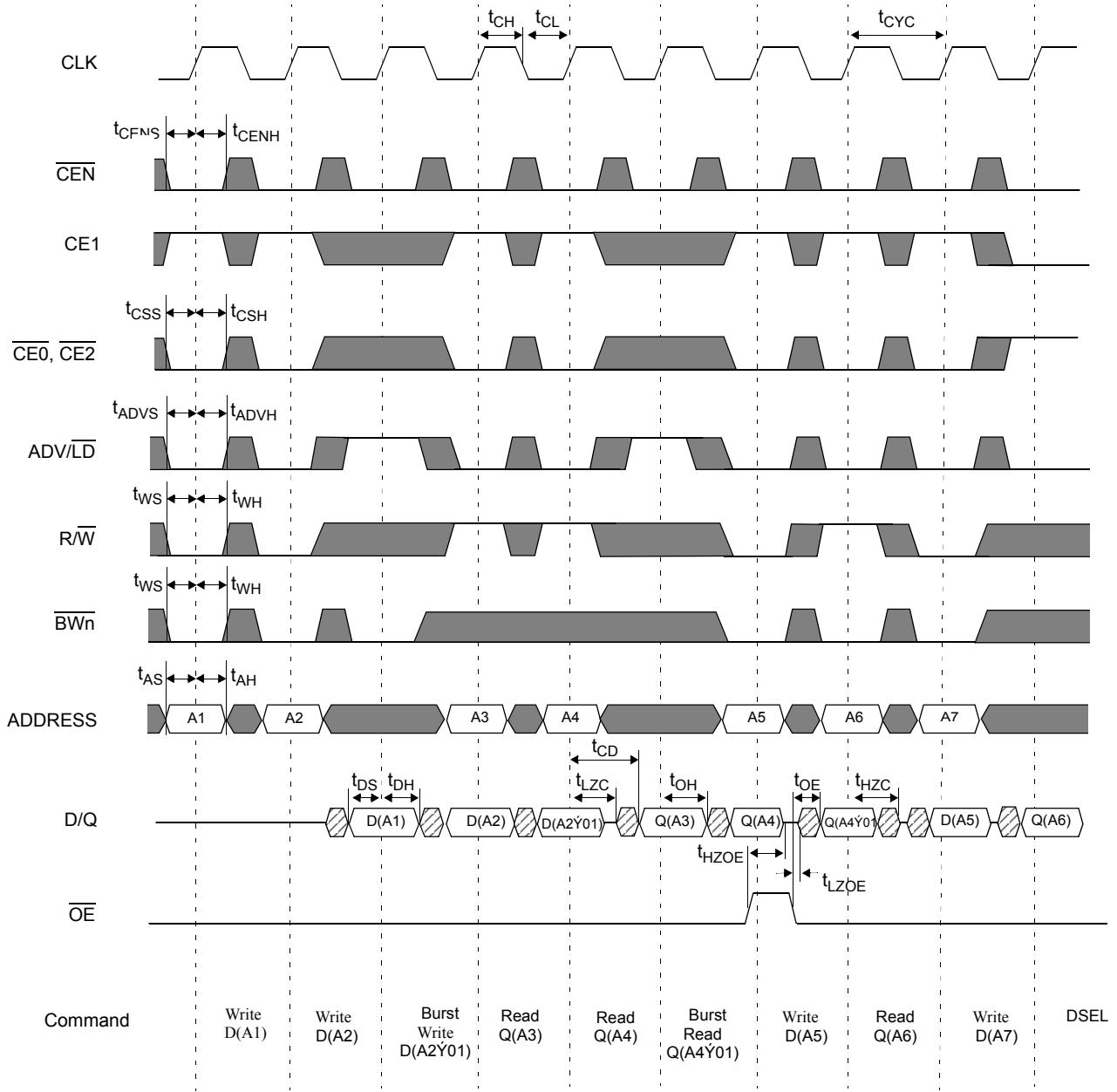

Note: $\dot{Y} = \text{XOR}$ when $\overline{\text{LBO}} = \text{high/no connect}$. $\dot{Y} = \text{ADD}$ when $\overline{\text{LBO}} = \text{low}$. $\overline{\text{BW}}[a:d]$ is don't care.



NOP, stall and deselect cycles

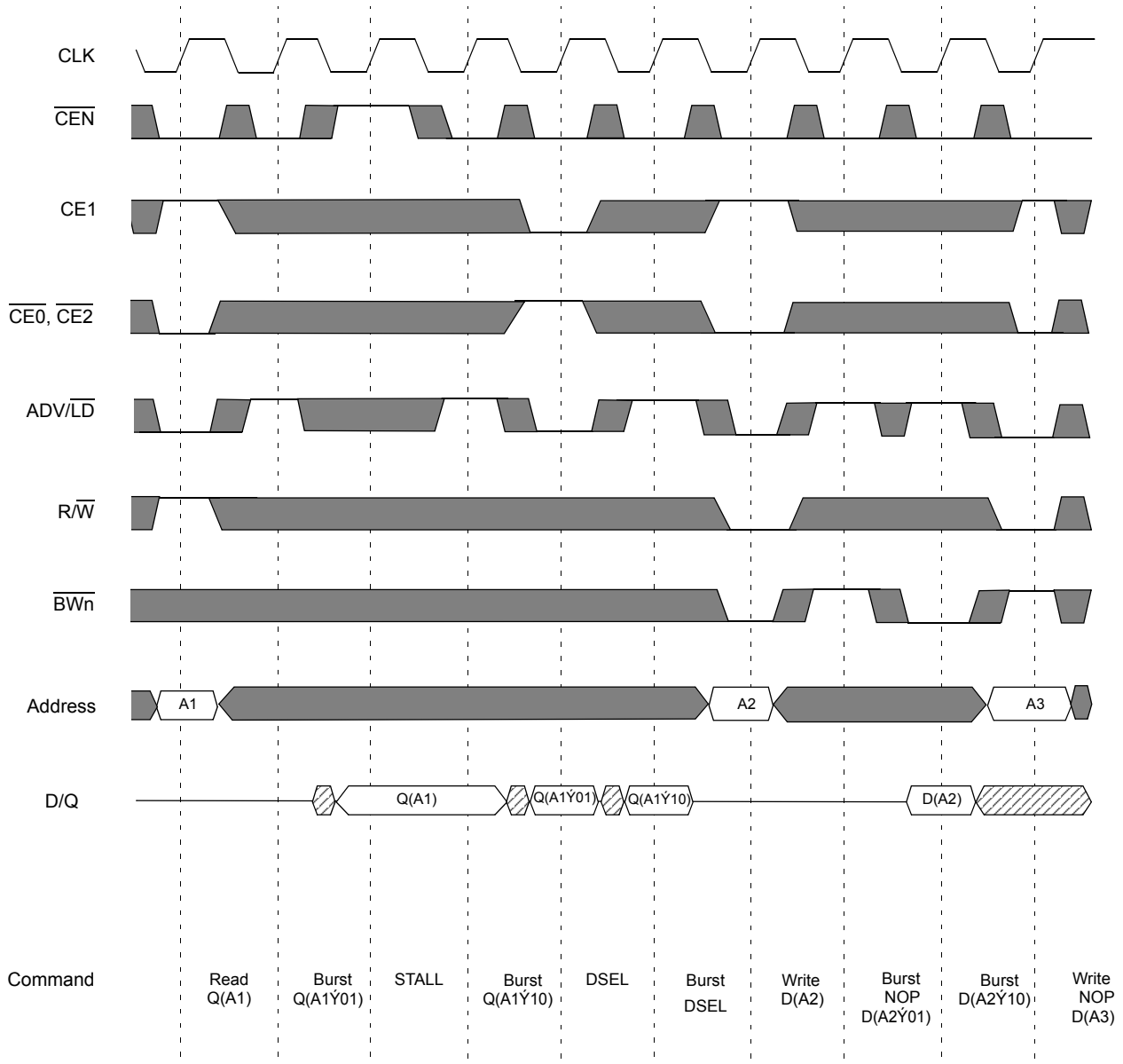

Note: \dot{Y} = XOR when \overline{LBO} = high/no connect; \dot{Y} = ADD when \overline{LBO} = low. \overline{OE} is low.



Timing waveform of snooze mode

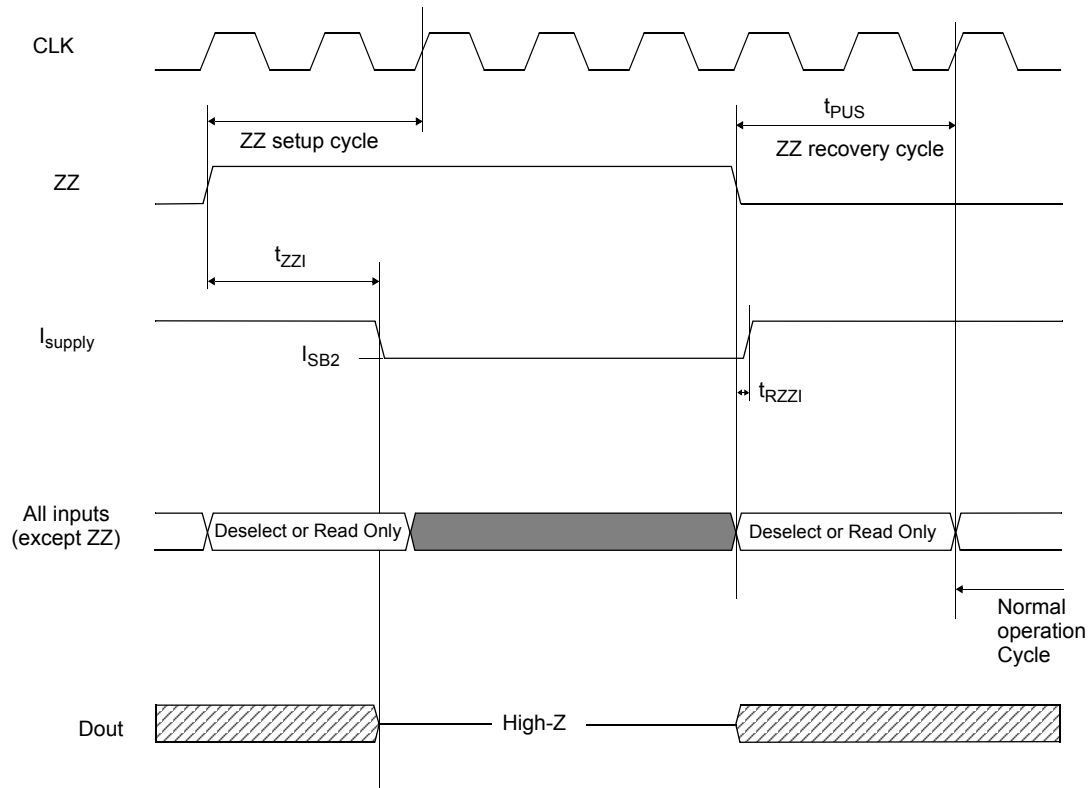



AC test conditions

- Output load: see Figure B, except for t_{LZC} , t_{LZOE} , t_{HZOE} , t_{HZC} , see Figure C.
- Input pulse level: GND to 3V. See Figure A.
- Input rise and fall time (measured at 0.3V and 2.7V): 2 ns. See Figure A.
- Input and output timing reference levels: 1.5V.

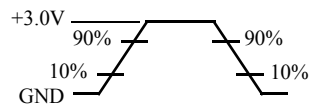

Figure A: Input waveform

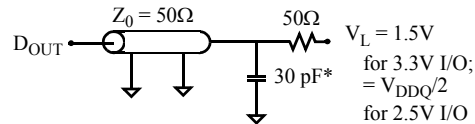

Figure B: Output load (A)

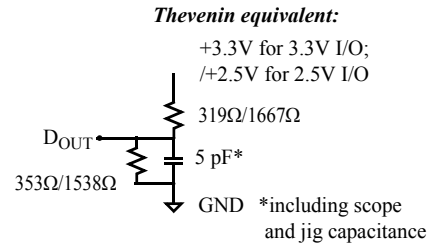

Figure C: Output load(B)

Notes:

- 1) For test conditions, see “AC test conditions”, Figures A, B, C
- 2) This parameter measured with output load condition in Figure C.
- 3) This parameter is sampled, but not 100% tested.
- 4) t_{HZOE} is less than t_{LZOE} and t_{HZC} is less than t_{LZC} at any given temperature and voltage.
- 5) t_{CH} measured high above V_{IH} and t_{CL} measured as low below V_{IL}
- 6) This is a synchronous device. All addresses must meet the specified setup and hold times for all rising edges of CLK. All other synchronous inputs must meet the setup and hold times with stable logic levels for all rising edges of CLK when chip is enabled.
- 7) Write refers to R/\overline{W} and $\overline{BW}[a,b]$.
- 8) Chip select refers to $\overline{CE0}$, CE1, and $\overline{CE2}$.



Package dimensions

100-pin quad flat pack (TQFP)

	TQFP	
	Min	Max
A1	0.05	0.15
A2	1.35	1.45
b	0.22	0.38
c	0.09	0.20
D	13.90	14.10
E	19.90	20.10
e	0.65 nominal	
Hd	15.85	16.15
He	21.80	22.20
L	0.45	0.75
L1	1.00 nominal	
α	0°	7°
Dimensions in millimeters		

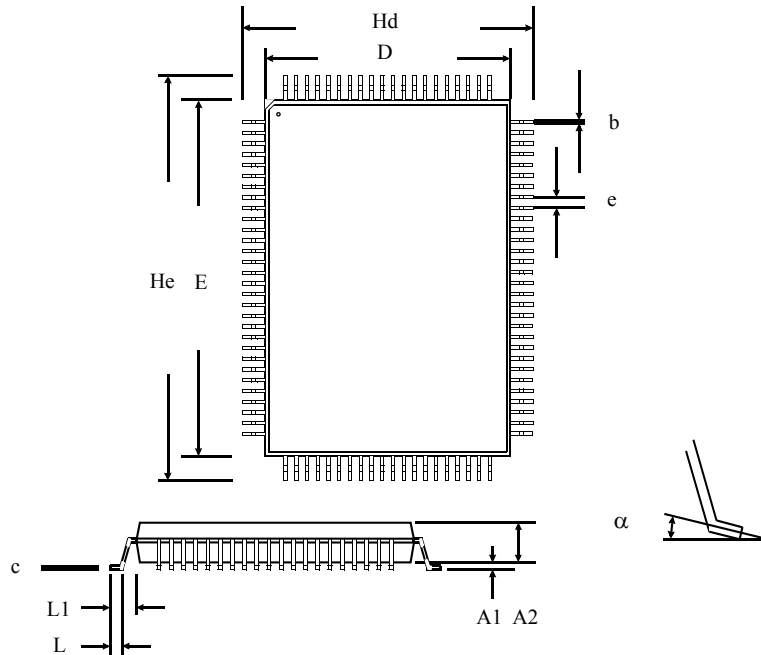



Ordering information

Package & Width	-75	-85	-10
TQFP x18	AS7C331MNTF18A-75TQC	AS7C331MNTF18A-85TQC	AS7C331MNTF18A-10TQC
	AS7C331MNTF18A-75TQI	AS7C331MNTF18A-85TQI	AS7C331MNTF18A-10TQI

Note: Add suffix 'N' to the above part numbers for Lead Free Parts (Ex. AS7C331MNTF18A-85TQCN)

Part numbering guide

AS7C	33	1M	NTF	18	A	-XX	TQ	C/I	X
1	2	3	4	5	6	7	8	9	10

- Alliance Semiconductor SRAM prefix
- Operating voltage: 33 = 3.3V
- Organization: 1M
- NTF = No Turn-Around Delay. Flow-through mode
- Organization: 18 = x 18
- Production version: A = first production version
- Clock access time: [-75 = 7.5 ns; -85 = 8.5 ns; -10 = 10.0 ns]
- Package type: TQ = TQFP
- Operating temperature: C = commercial (0° C to 70° C); I = industrial (-40° C to 85° C)
- N = Lead free part



Alliance Semiconductor Corporation
2575, Augustine Drive,
Santa Clara, CA 95054
Tel: 408 - 855 - 4900
Fax: 408 - 855 - 4999
www.alsc.com

Copyright © Alliance Semiconductor
All Rights Reserved
Part Number: AS7C331MNTF18A
Document Version: v 1.2

© Copyright 2003 Alliance Semiconductor Corporation. All rights reserved. Our three-point logo, our name and Intelliwatt are trademarks or registered trademarks of Alliance. All other brand and product names may be the trademarks of their respective companies. Alliance reserves the right to make changes to this document and its products at any time without notice. Alliance assumes no responsibility for any errors that may appear in this document. The data contained herein represents Alliance's best data and/or estimates at the time of issuance. Alliance reserves the right to change or correct this data at any time, without notice. If the product described herein is under development, significant changes to these specifications are possible. The information in this product data sheet is intended to be general descriptive information for potential customers and users, and is not intended to operate as, or provide, any guarantee or warrantee to any user or customer. Alliance does not assume any responsibility or liability arising out of the application or use of any product described herein, and disclaims any express or implied warranties related to the sale and/or use of Alliance products including liability or warranties related to fitness for a particular purpose, merchantability, or infringement of any intellectual property rights, except as express agreed to in Alliance's Terms and Conditions of Sale (which are available from Alliance). All sales of Alliance products are made exclusively according to Alliance's Terms and Conditions of Sale. The purchase of products from Alliance does not convey a license under any patent rights, copyrights; mask works rights, trademarks, or any other intellectual property rights of Alliance or third parties. Alliance does not authorize its products for use as critical components in life-supporting systems where a malfunction or failure may reasonably be expected to result in significant injury to the user, and the inclusion of Alliance products in such life-supporting systems implies that the manufacturer assumes all risk of such use and agrees to indemnify Alliance against all claims arising from such use.