

Power Integrated Module (PIM)

■ Features

- Included Rectifier and Brake Chopper
- Square RBSOA
- Low Saturation Voltage
- Overcurrent Limiting Function
(~ 3 Times Rated Current)

■ Equivalent Circuit

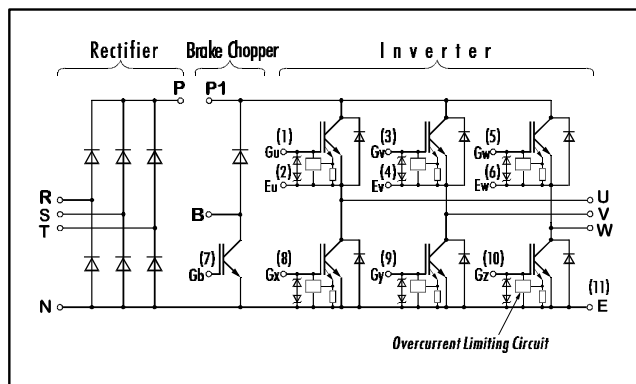

■ Outline Drawing

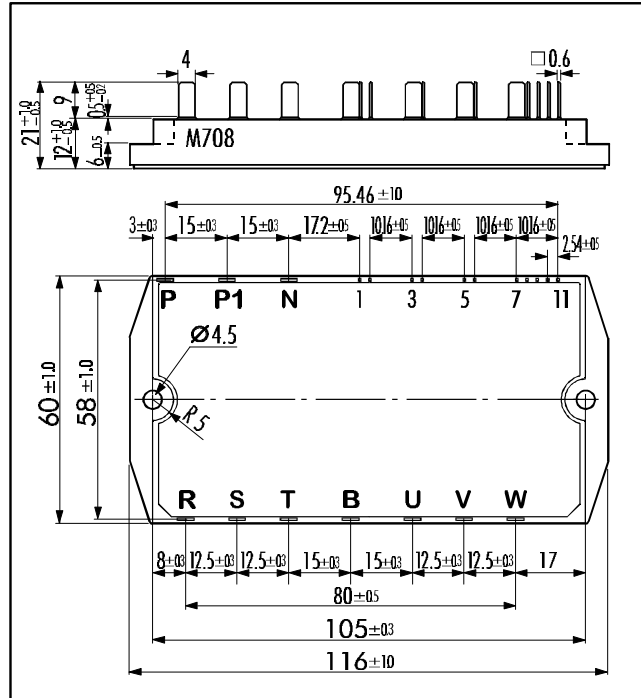

■ Absolute Maximum Ratings ($T_c=25^\circ\text{C}$)

	Items	Symbols	Test Conditions	Ratings	Units	
Inverter	Collector-Emitter Voltage	V_{CES}		600	V	
	Gate -Emitter Voltage	V_{GES}		± 20		
	Collector Current	I_C		Continuous	50	A
		$I_{C\ PULSE}$		1ms	100	
		$-I_{C\ PULSE}$		1ms	50	
Collector Power Dissipation	P_C		1 device	200	W	
Rectifier	Repetitive Peak Reverse Voltage	V_{RRM}		800	V	
	Non Repetitive Peak Reverse Voltage	V_{RSM}		900		
	Average Output Current	I_O	50Hz/60Hz sin. wave	50	A	
	Surge Current (Non Repetitive)	I_{FSM}	$T_j=150^\circ\text{C}$, 10ms	350		
	I^2t (Non Repetitive)		$T_j=150^\circ\text{C}$, 10ms	648		A^2s
Brake Chopper IGBT FWD	Collector-Emitter Voltage	V_{CES}		600	V	
	Gate -Emitter Voltage	V_{GES}		± 20		
	Collector Current	I_C		Continuous	50	A
		$I_{C\ PULSE}$		1ms	100	
	Collector Power Dissipation	P_C		1 device	200	W
	Repetitive Peak Reverse Voltage	V_{RRM}		600	V	
	Average Forward Current	$I_{F(AV)}$		1	A	
	Surge Current	I_{FSM}	10ms	50		
	Operating Junction Temperature	T_j		+150	$^\circ\text{C}$	
	Storage Temperature	T_{Stg}		-40 ~ +125		
Isolation Voltage	V_{ISO}		A.C. 1min.	2500	V	
Mounting Screw Torque *1				1.7	Nm	

Note: *1:Recommendable Value; 1.3 ~ 1.7 Nm (M4)

■ Electrical Characteristics (T_j=25°C)

	Items	Symbols	Test Conditions	Min.	Max.	Units	
Inverter	IGBT	Zero Gate Voltage Collector Current	I _{CES}	V _{GE} =0V V _{CE} =600V		1.0	mA
		Gate-Emitter Leakage Current	I _{GES}	V _{CE} =0V V _{GE} =±20V		20	μA
		Gate-Emitter Threshold Voltage	V _{GE(th)}	V _{GE} =20V I _C =50mA	4.5	7.5	V
		Collector-Emitter Saturation Voltage	V _{CE(sat)}	V _{GE} =15V I _C =50A		2.9	
		Input capacitance	C _{ies}	f=1MHz, V _{GE} =0V, V _{CE} =10V	3300 (typ.)		pF
	FWD	Turn-on Time	t _{on}	V _{CC} = 300V I _C = 50A V _{GE} = ±15V R _G = 51Ω		1.2	μs
			t _r			0.6	
		Turn-off Time	t _{off}			1.0	
			t _f			0.35	
	Rectif.	Diode Forward On-Voltage	V _F	I _F =50A V _{GE} =0V		3.1	V
Reverse Recovery Time		t _{rr}	I _F =50A		350	ns	
Brake Chopper	IGBT	Zero Gate Voltage Collector Current	I _{CES}	V _{GE} =0V V _{CE} =600V		1.0	mA
		Gate-Emitter Leakage Current	I _{GES}	V _{CE} =0V V _{GE} =±20V		100	nA
		Collector-Emitter Saturation Voltage	V _{CE(sat)}	V _{GE} =15V I _C =50A		2.8	V
	FWD	Turn-on Time	t _{on}	V _{CC} = 300V I _C = 50A V _{GE} = ±15V R _G = 51Ω		0.8	μs
			t _r			0.6	
		Turn-off Time	t _{off}			1.0	
			t _f			0.35	
FWD	Reverse Current	I _R	V _R =600V		1.0	mA	
	Reverse Recovery Time	t _{rr}			600	ns	

■ Thermal Characteristics

Items	Symbols	Test Conditions	Min.	Max.	Units
Thermal Resistance (1 device)	R _{th(j-c)}	Inverter IGBT		0.63	°C/W
		Inverter FRD		1.60	
		Brake IGBT		0.63	
		Converter Diode		2.10	
Contact Thermal Resistance	R _{th(c-f)}	With Thermal Compound	0.05 (typ.)		

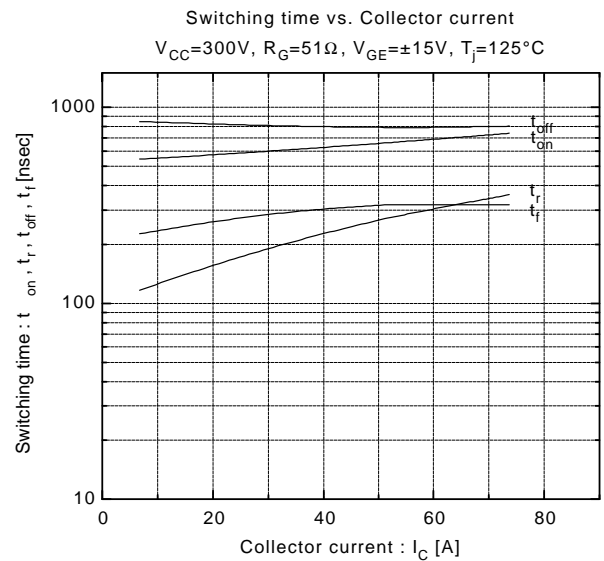
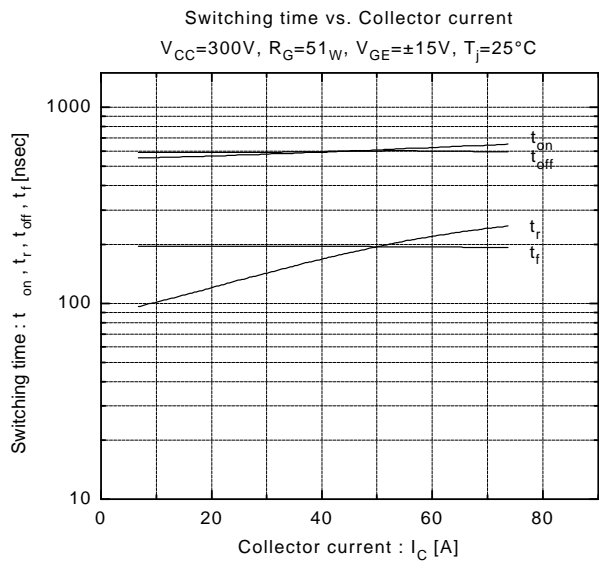
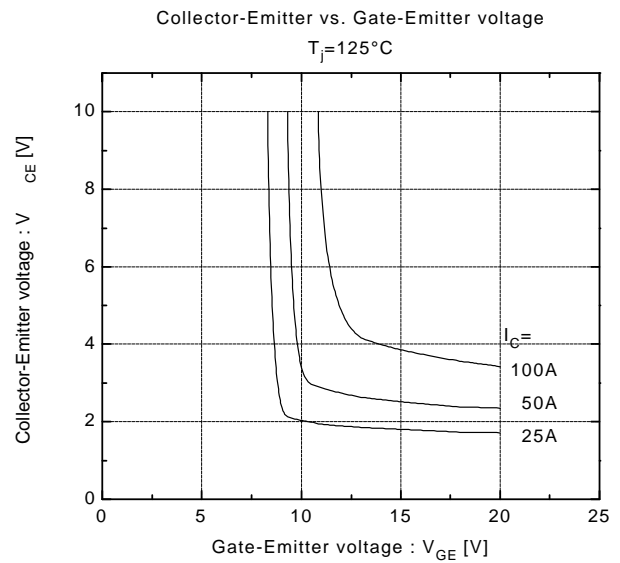
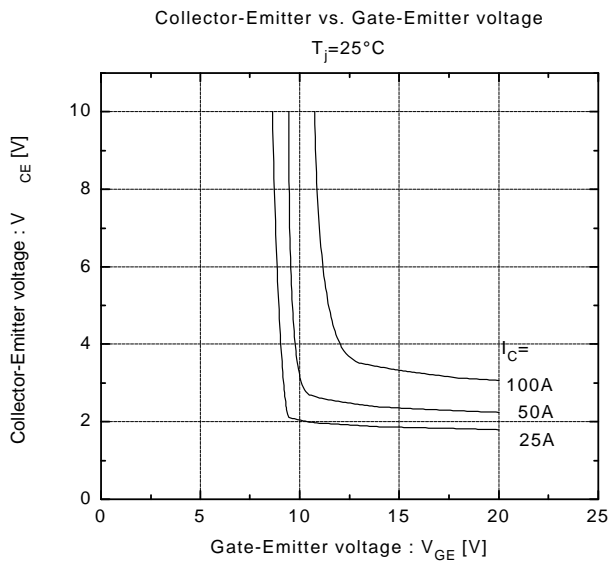
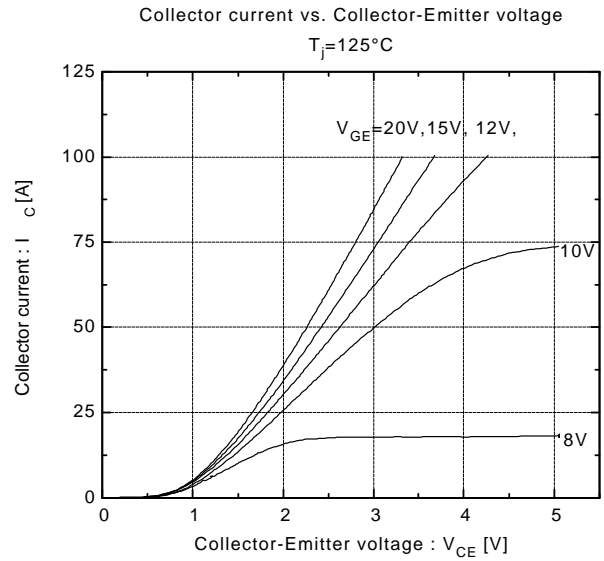
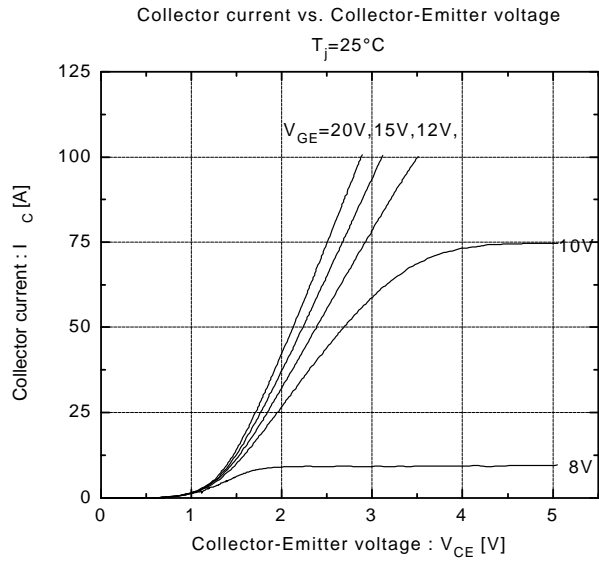

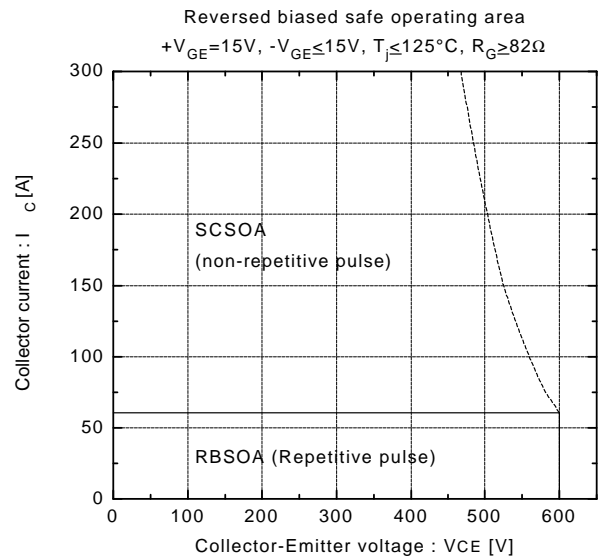
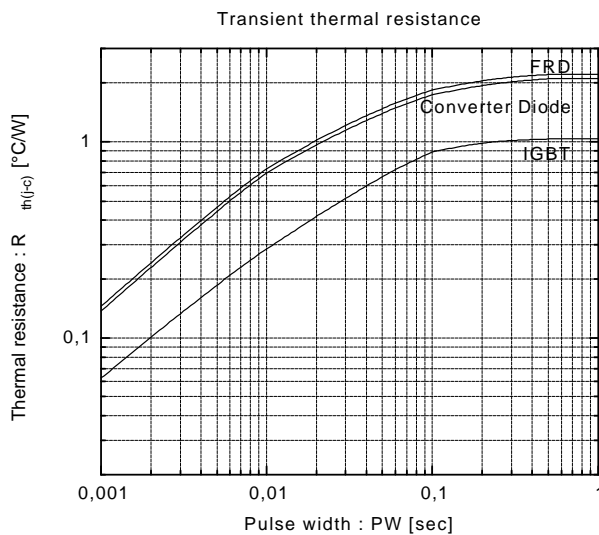
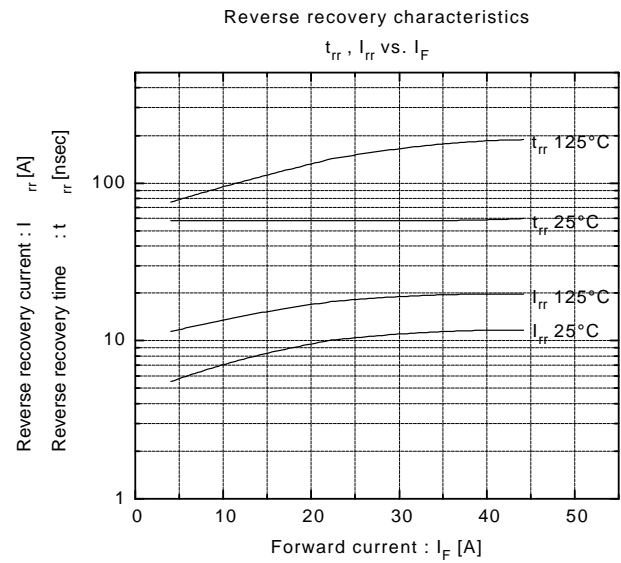
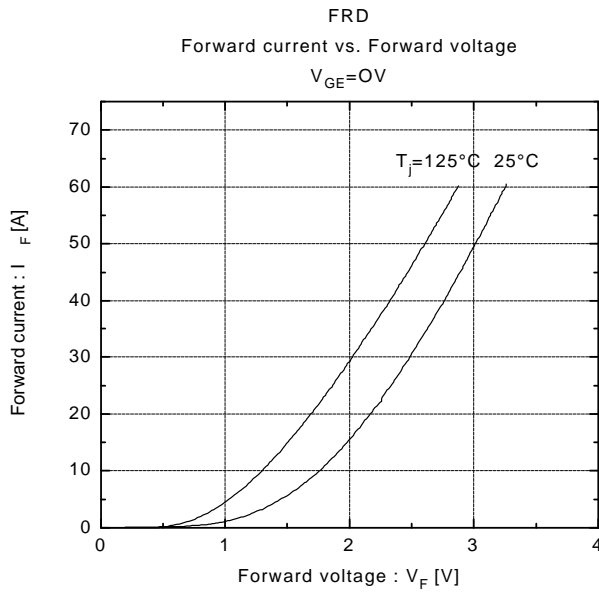
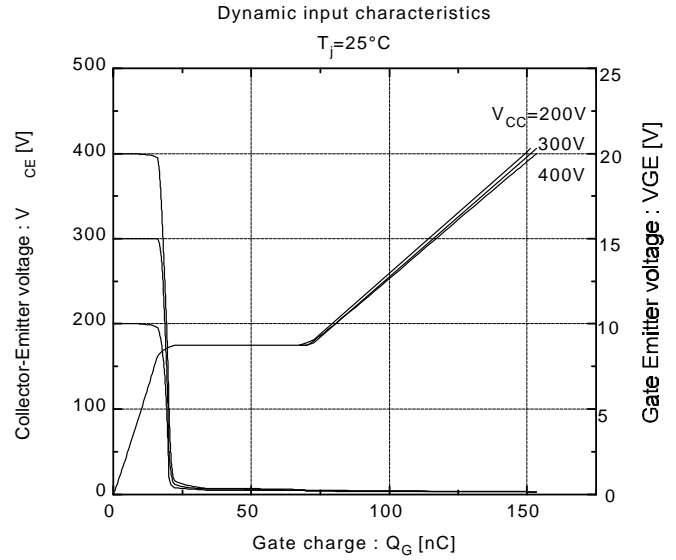
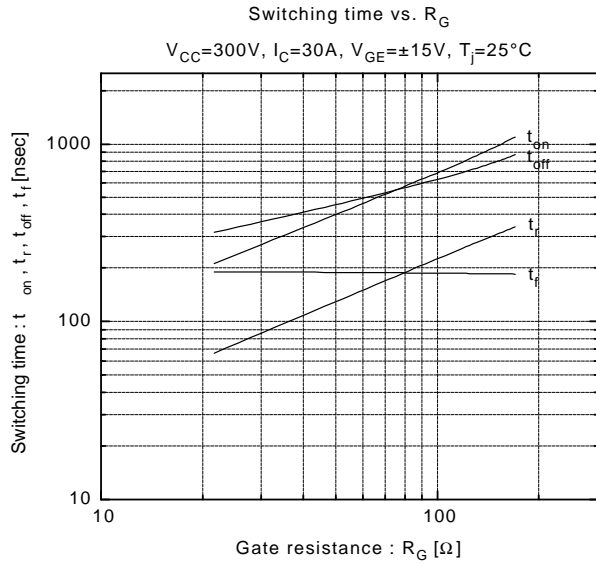

Switching loss vs. Collector current

$V_{CC}=300V, R_G=51\Omega, V_{GE}=\pm 15V$

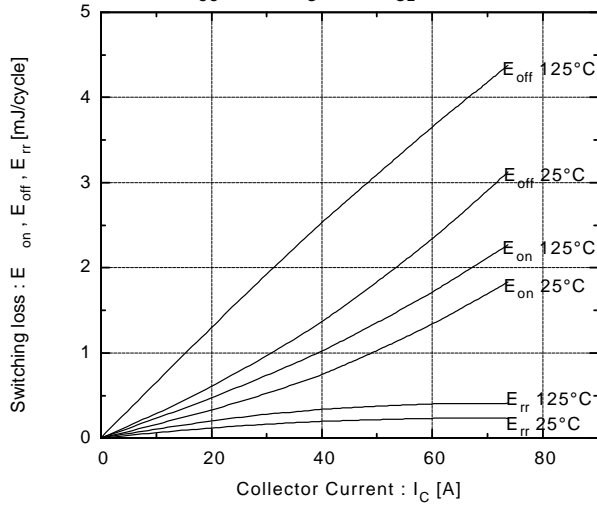

Capacitance vs. Collector-Emitter voltage

$T_J=25^\circ C$

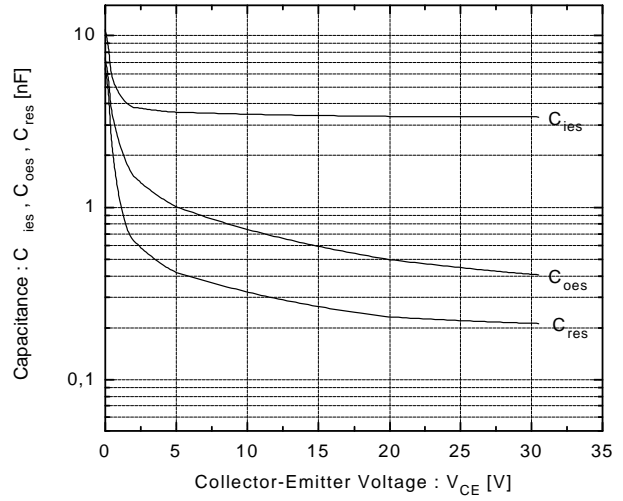

Converter Diode

Forward current vs. Forward voltage

$V_{GE}=0V$

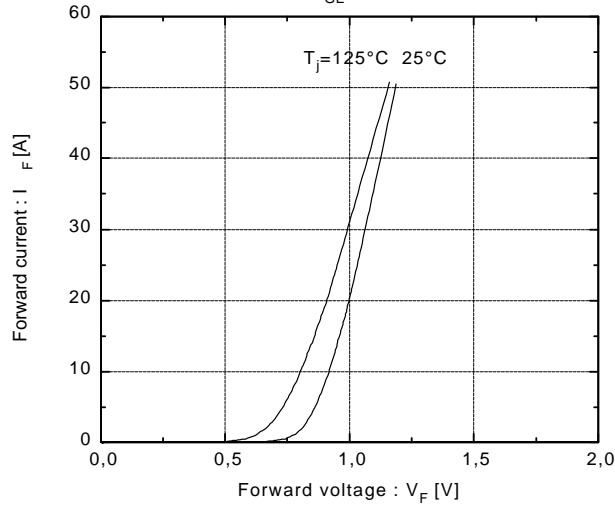

Brake Chopper IGBT

Collector current vs. Collector-Emmitter voltage

$T_J=25^\circ\text{C}$

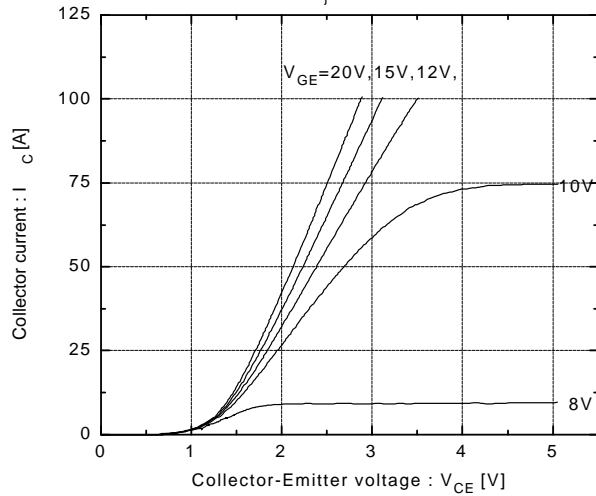

Collector current vs. Collector-Emmitter voltage

$T_J=125^\circ\text{C}$

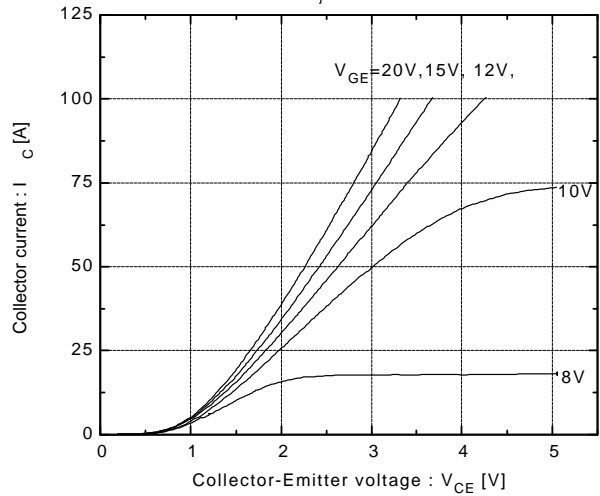

Collector-Emmitter vs. Gate-Emmitter voltage

$T_J=25^\circ\text{C}$

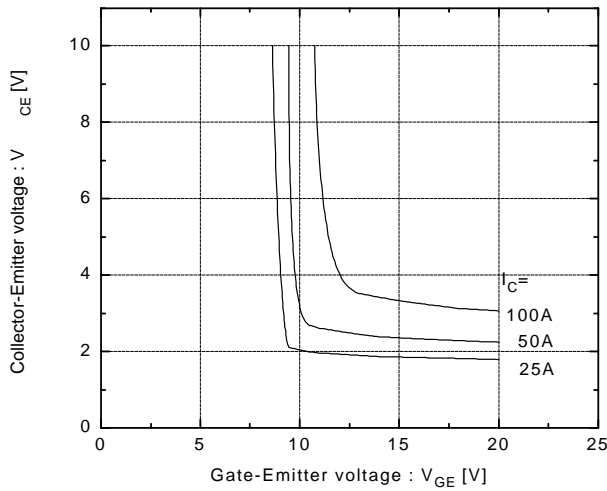

Collector-Emmitter vs. Gate-Emmitter voltage

$T_J=125^\circ\text{C}$

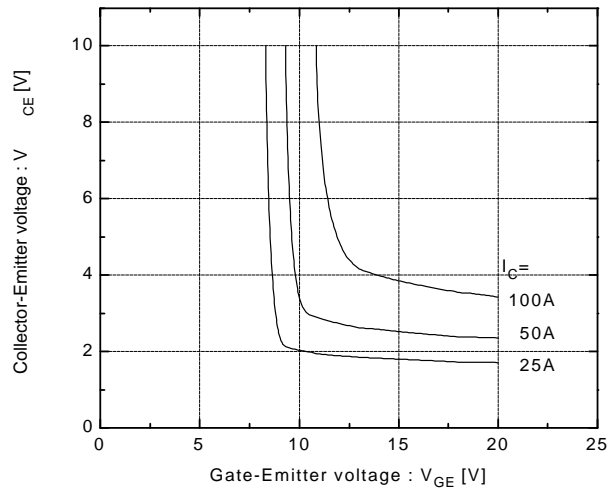

Switching time vs. Collector current

$V_{CC}=300\text{V}, R_G=51\Omega, V_{GE}=\pm 15\text{V}, T_J=25^\circ\text{C}$

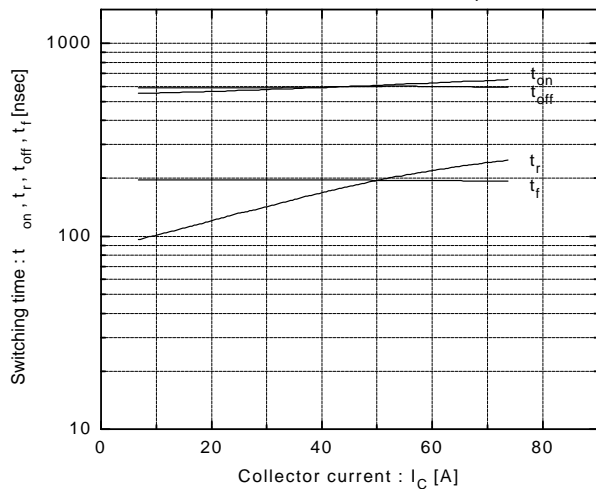

Switching time vs. Collector current

$V_{CC}=300\text{V}, R_G=51\Omega, V_{GE}=\pm 15\text{V}, T_J=125^\circ\text{C}$

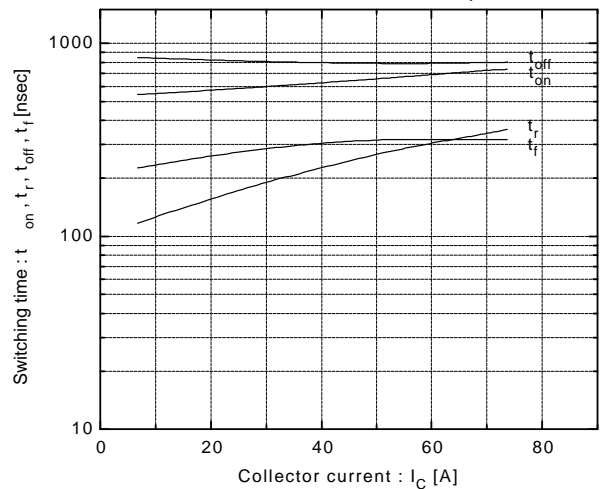

Brake Chopper IGBT

