

MWA210
MWA220
MWA230

The RF Line

WIDEBAND HYBRID AMPLIFIERS

... single stage amplifiers designed for broadband linear applications up to 600 MHz.

- Low-Cost TO-39 Type Package
- Gain 10 dB Typ
- 50 Ω Input and Output Impedance
- Fully Cascadable for Any Gain
- Thin Film Construction
- Hermetic Package
- Guaranteed Performance from -25°C to +100°C

**DC-600 MHz WIDEBAND
GENERAL-PURPOSE
HYBRID AMPLIFIERS**



MAXIMUM RATINGS

Rating	Symbol	Value			Unit
		MWA210	MWA220	MWA230	
RF Input Power	P _{in}	← 100 →			mW
DC Supply Current	I _D	25	55	100	mA
Maximum Case Temperature	T _C	← 125 →			°C
Storage Temperature Range	T _{stg}	← -65 to +200 →			°C

OPERATING CONDITIONS

Device Voltage	V _D	1.75	3.2	4.4	V _{dc}
Device Current	I _D	10	25	60	mA _{dc}
Decoupling Impedance	Z _D	620	620	240	Ω

THERMAL CHARACTERISTICS

Characteristic	Symbol	Max	Unit
Thermal Resistance, Junction to Case	R _{θJC}	110	°C/W

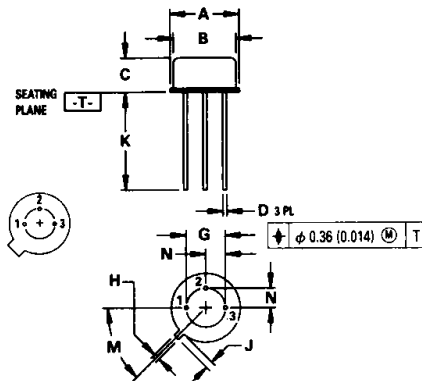

STYLE 2:
PIN 1. INPUT
PIN 2. OUTPUT
PIN 3. GROUND

NOTES:
1. DIMENSIONING AND TOLERANCING PER ANSI Y14.5M, 1982.
2. CONTROLLING DIMENSION: INCH.

DIM	MILLIMETERS		INCHES	
	MIN	MAX	MIN	MAX
A	8.51	9.39	0.335	0.370
B	7.75	8.50	0.305	0.335
C	3.81	4.57	0.165	0.185
D	0.41	0.48	0.016	0.019
G	5.08 BSC		0.200 BSC	
H	0.72	0.86	0.028	0.034
J	0.74	1.14	0.029	0.045
K	12.70	—	0.500	—
M	45° BSC		45° BSC	
N	2.54 BSC		0.100 BSC	

CASE 31A-03

MWA210, MWA220, MWA230

ELECTRICAL CHARACTERISTICS (T_C = -25 to +100°C, 50 Ω system and specified operating conditions)

Characteristic	Symbol	Min	Typ	Max	Unit
Frequency Range	BW	0.1	—	600	MHz
Power Gain (f = 100 MHz)	G _p	9.0	10	—	dB
Response Flatness	F	—	0	±1.0	dB
Input VSWR	MWA210/220 MWA230	— —	— —	2.5:1 3:1	—
Output VSWR	MWA210/220/230	—	—	2.5:1	—
Output @ 1 dB Gain Compression	MWA210 MWA220 MWA230	— — —	+1.5 +10.5 +18.5	— — —	dBm
Noise Figure	MWA210 MWA220 MWA230	— — —	6.0 6.5 7.5	— — —	dB
Reverse Isolation	MWA210 MWA220 MWA230	— — —	13.5 14.5 12.9	— — —	dB
Harmonic Output	MWA210 (P _{out} = -9.0 dBm) MWA220 (P _{out} = 0 dBm) MWA230 (P _{out} = +10 dBm)	— — —	-29 -36 -36	— — —	dB

FIGURE 1 – DEVICE VOLTAGE versus DEVICE CURRENT

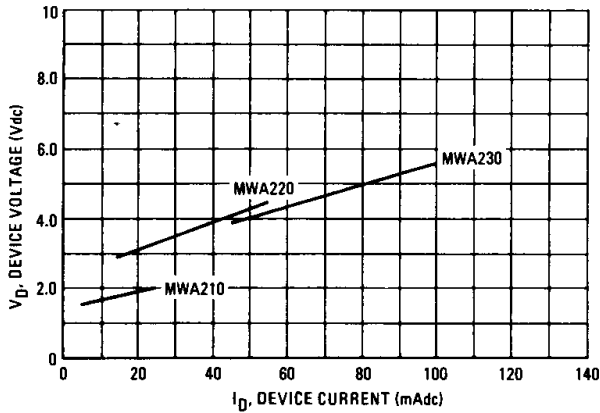

FIGURE 2 – DEVICE CURRENT versus CASE TEMPERATURE

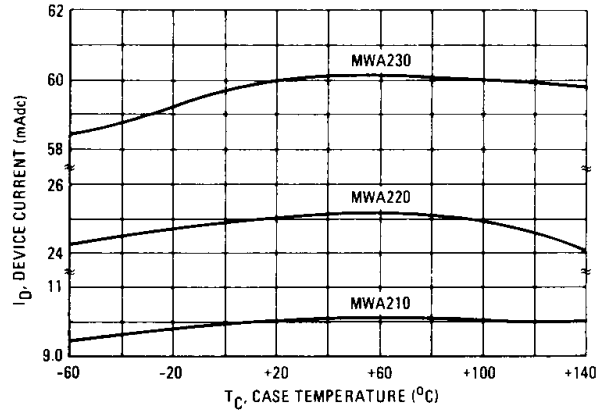

FIGURE 3 – POWER GAIN versus FREQUENCY

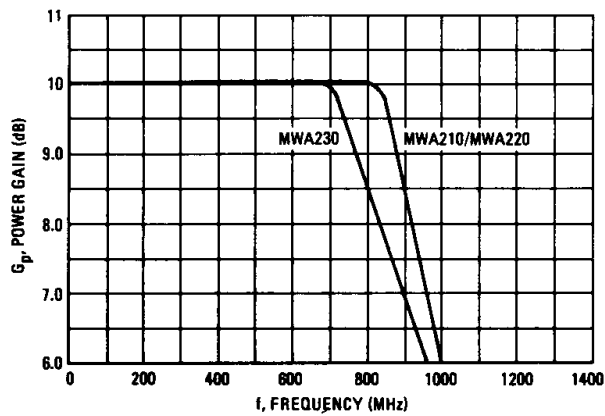
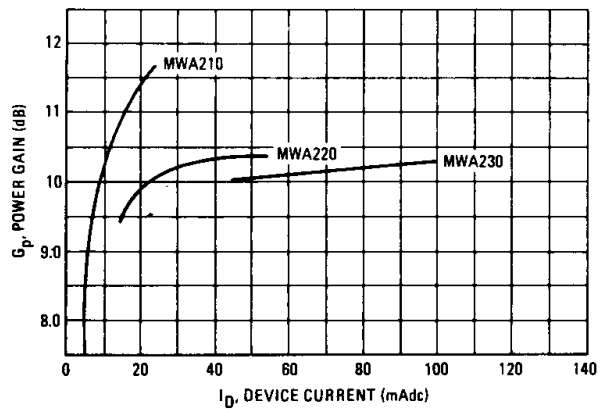

FIGURE 4 – POWER GAIN versus DEVICE CURRENT
f = 600 MHz



MWA210, MWA220, MWA230

FIGURE 5 – POWER GAIN versus CASE TEMPERATURE
f = 100 MHz

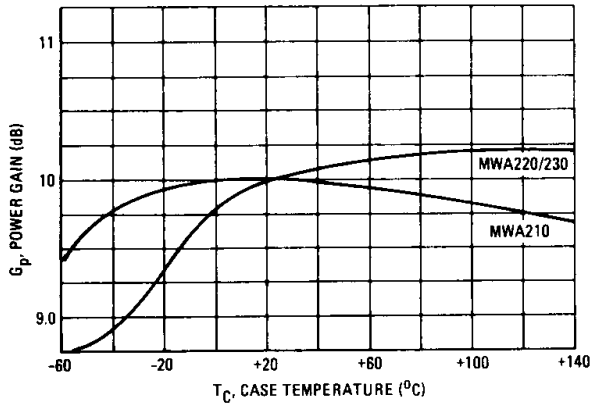

FIGURE 6 – POWER GAIN versus CASE TEMPERATURE
f = 600 MHz

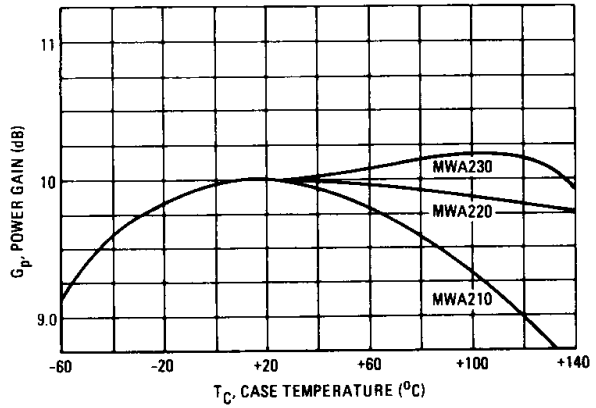

FIGURE 7 – VSWR versus FREQUENCY
MWA210

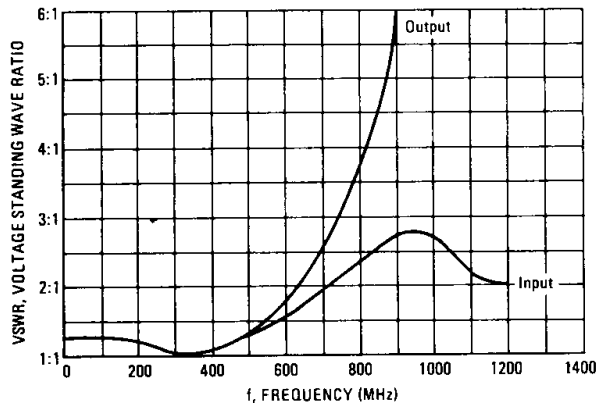

FIGURE 8 – VSWR versus FREQUENCY
MWA220

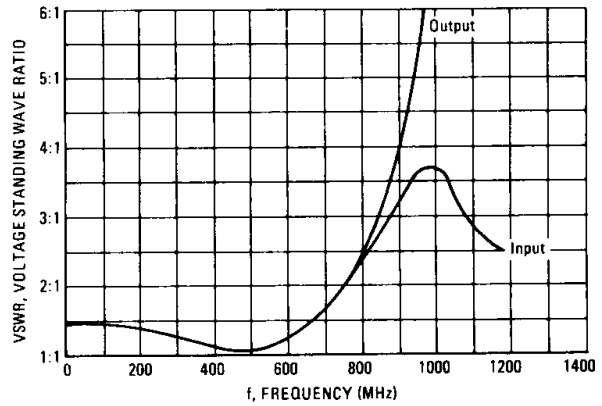
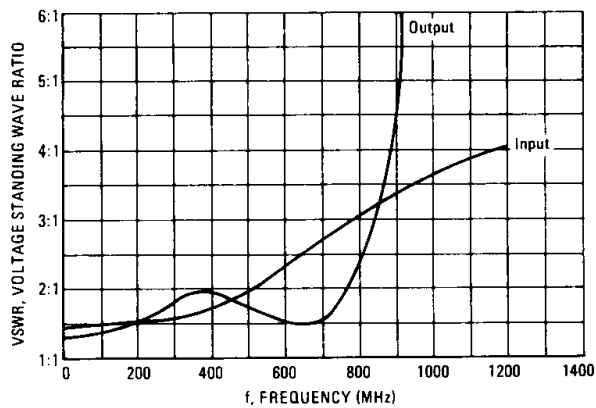

FIGURE 9 – VSWR versus FREQUENCY
MWA230



MWA210, MWA220, MWA230

FIGURE 10 – INPUT AND OUTPUT IMPEDANCE versus FREQUENCY MWA210

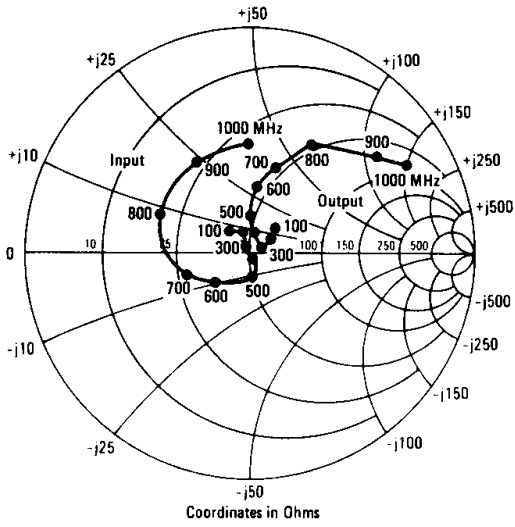

FIGURE 11 – INPUT AND OUTPUT IMPEDANCE versus FREQUENCY MWA220

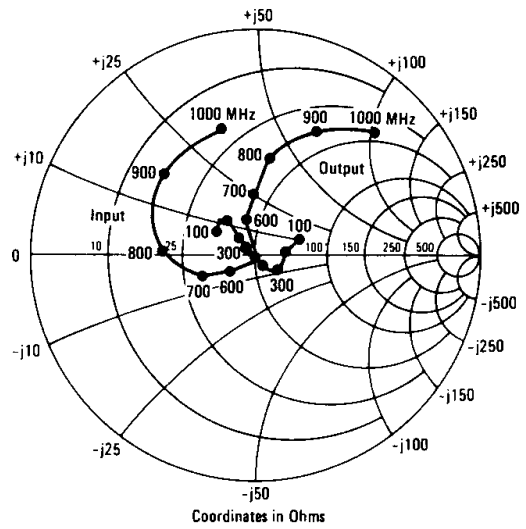

FIGURE 12 – INPUT AND OUTPUT IMPEDANCE versus FREQUENCY MWA230

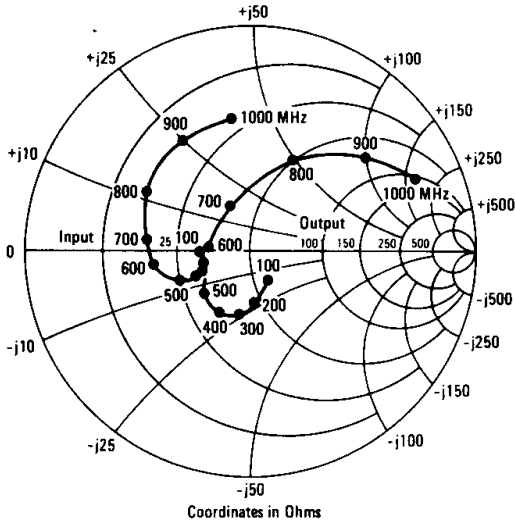
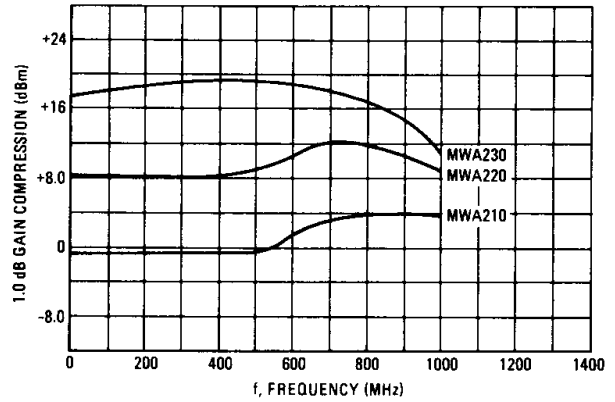

FIGURE 13 – 1.0 dB GAIN COMPRESSION versus FREQUENCY



5

MWA210, MWA220, MWA230

FIGURE 14 – 1.0 dB GAIN COMPRESSION versus DEVICE CURRENT $f = 600$ MHz

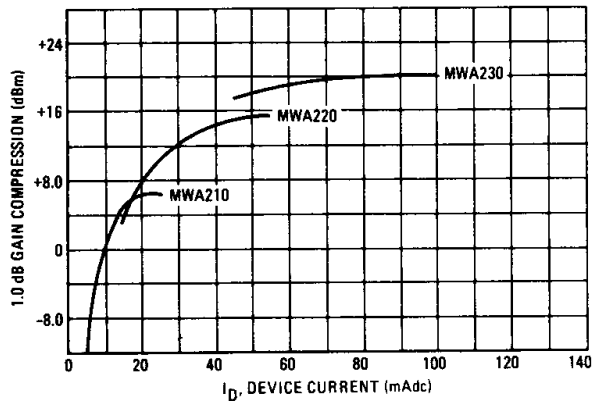

FIGURE 15 – 1.0 dB GAIN COMPRESSION versus CASE TEMPERATURE $f = 600$ MHz

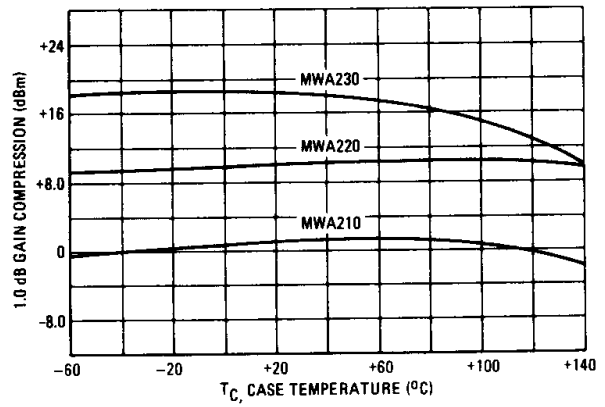

FIGURE 16 – NOISE FIGURE versus FREQUENCY

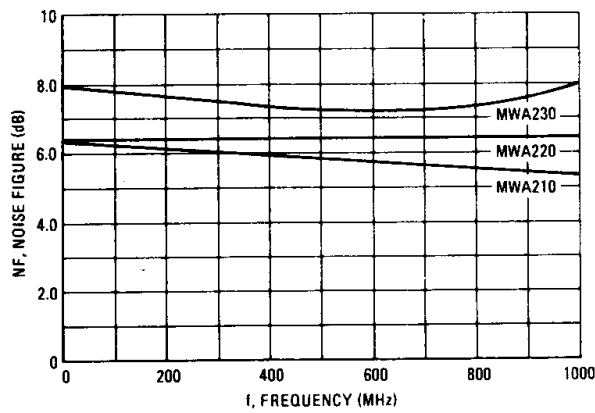

FIGURE 17 – REVERSE ISOLATION versus FREQUENCY

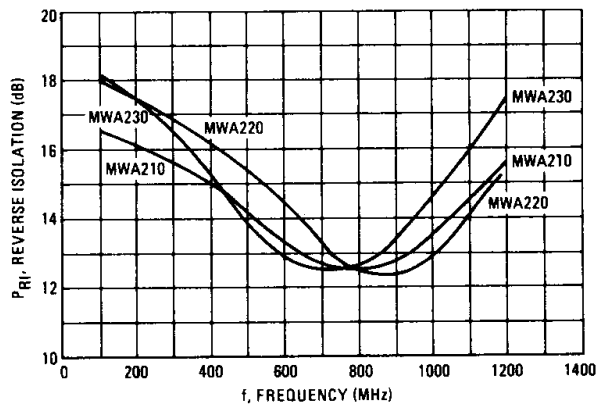

FIGURE 18 – SECOND HARMONIC OUTPUT versus FREQUENCY

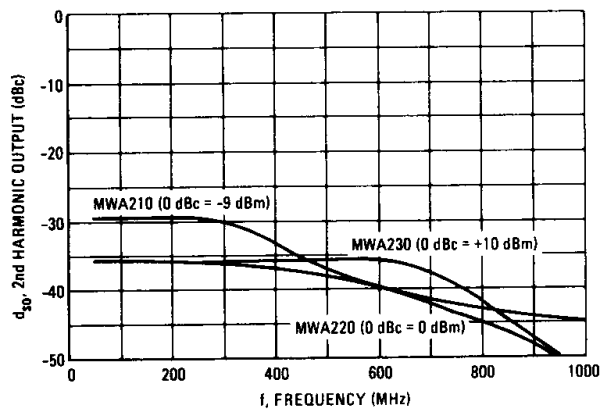
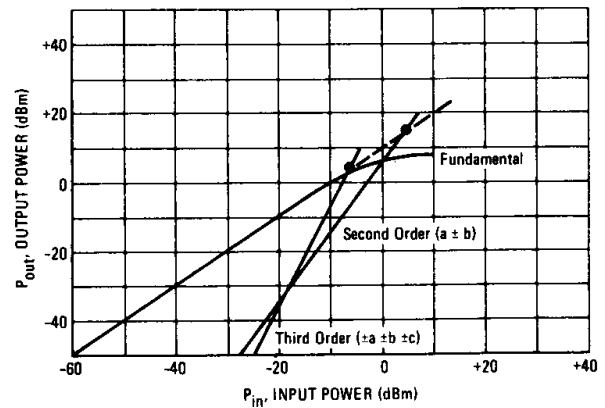
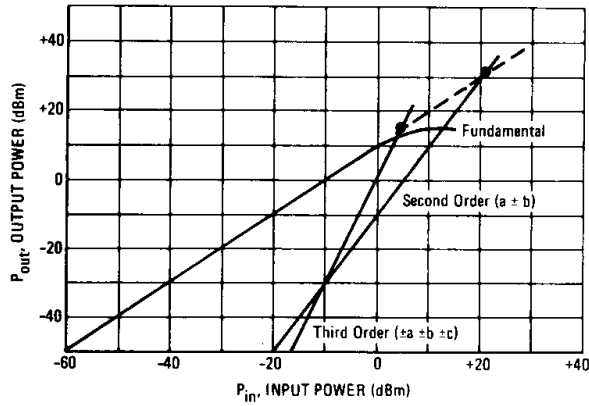

FIGURE 19 – SECOND AND THIRD ORDER INTERCEPT MWA210



MWA210, MWA220, MWA230

**FIGURE 20 – SECOND AND THIRD ORDER INTERCEPT
MWA220**



**FIGURE 21 – SECOND AND THIRD ORDER INTERCEPT
MWA230**

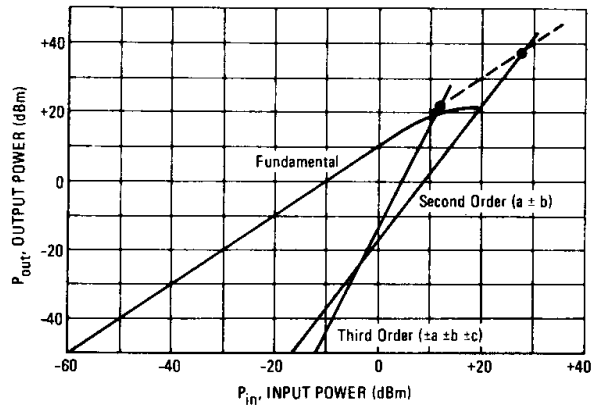

**FIGURE 22 – INTERMODULATION DISTORTION versus
POWER OUTPUT MWA210**

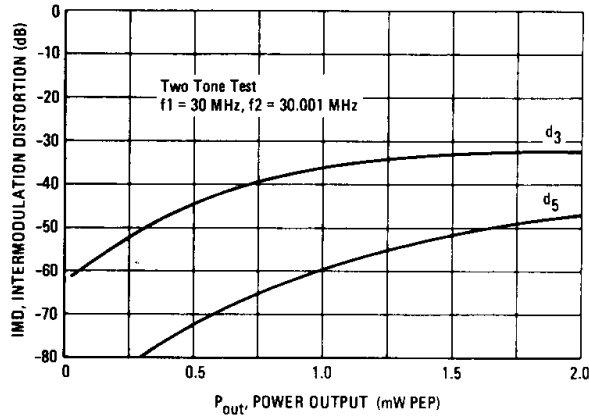

**FIGURE 23 – INTERMODULATION DISTORTION versus
POWER OUTPUT MWA220**

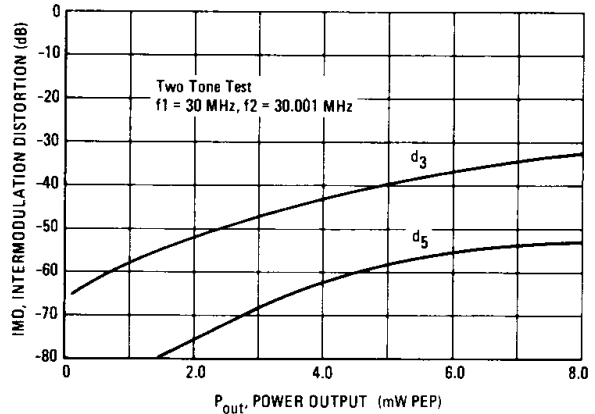

**FIGURE 24 – INTERMODULATION DISTORTION versus
POWER OUTPUT MWA230**

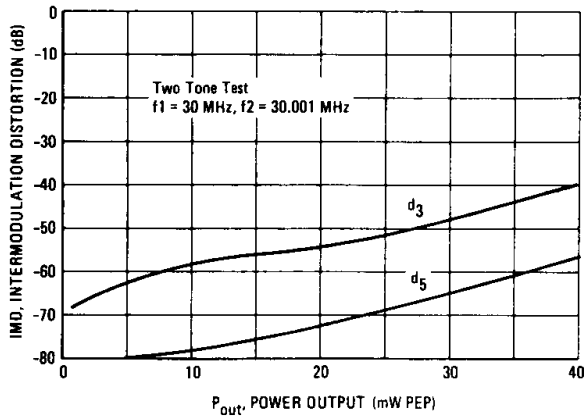
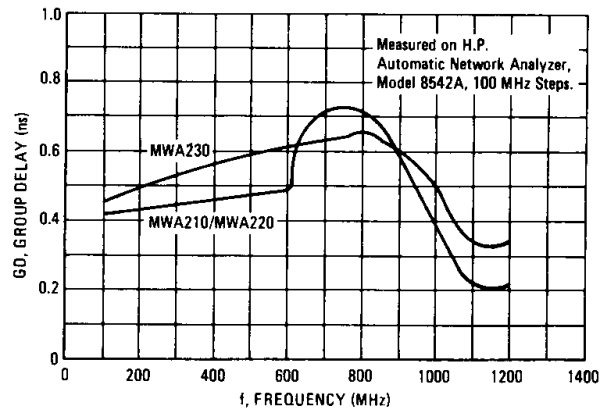

FIGURE 25 – GROUP DELAY versus FREQUENCY



5

MWA SERIES HYBRID AMPLIFIER APPLICATIONS INFORMATION

The MWA series hybrid amplifiers are designed for wideband general purpose applications in 50 Ω systems. Fully cascadable for any gain combination, operable at voltages as low as 3 Vdc, and external control of the low frequency corner make the MWA amplifiers extremely versatile gain blocks.

Basic Circuit Configuration

Figure 26 shows the basic internal circuit. It is important to note that the specified operating conditions of voltage, current, and external decoupling impedance must be applied to the units in order to achieve the published electrical characteristics.

FIGURE 26 – INTERNAL CIRCUIT

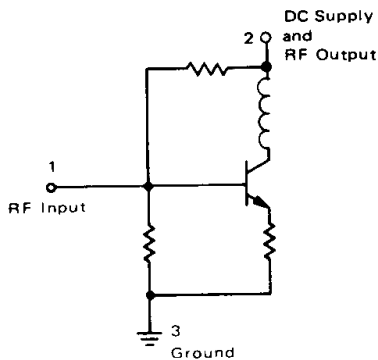

Amplifier Application

The circuit schematic for a simple amplifier design is shown in Figure 27. External to the MWA hybrid amplifier the only components required are:

- Decoupling elements – Bypass Capacitor
- Decoupling Impedance (resistor/inductor)

DC Blocking Capacitors at the RF input and output.

External Decoupling Impedance

In all cases the external bias (decoupling elements) must present an impedance which is large compared to the 50 Ω load impedance to minimize RF gain reduction. The loss in gain due to the decoupling impedance is given by the equation:

$$\text{Loss} = 20 \text{ Log } \frac{Z_D}{Z_D + 25} \text{ dB}$$

where Z_D = decoupling impedance in ohms. For example, if $Z_D = 1 \text{ k}\Omega$, Loss = 0.214 dB.

FIGURE 27 – AMPLIFIER SCHEMATIC DIAGRAM

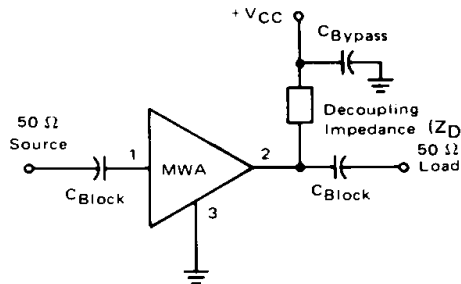

Supply Voltage

The value of the external decoupling resistive impedance (R_D) determines the supply voltage ($+V_{CC}$) and is determined by the following equation:

$$V_{CC} = R_D \times I_D + V_D$$

where I_D and V_D are the device current and voltage stated in the data sheet. For example, for MWA110,

$$I_D = 10 \text{ mA}$$

$$V_D = 2.9 \text{ V}$$

and, if $R_D = 330 \Omega$, then

$$V_{CC} = 6.2 \text{ V}$$

More commonly V_{CC} is predetermined and R_D may be calculated from:

$$R_D = \frac{V_{CC} - V_D}{I_D}$$

An RF choke is not recommended for use as a decoupling impedance without also using a resistor having an appropriate value.

Low Frequency Response

The value of the blocking capacitors determines the low frequency response of the amplifier. The following expression is used to determine the blocking capacitor value to yield a desired 3 dB low frequency corner (f_{LFC}).

$$C_{\text{Block}}(\text{Farads}) = \frac{1}{100 \pi f_{LFC}(\text{Hz})}$$

Bypass Capacitor

The reactive impedance of the bypass capacitor should be small compared to the impedance of the decoupling element at the lowest frequency of operation.

MWA210, MWA220, MWA230

FIGURE 28 — TEST FIXTURE

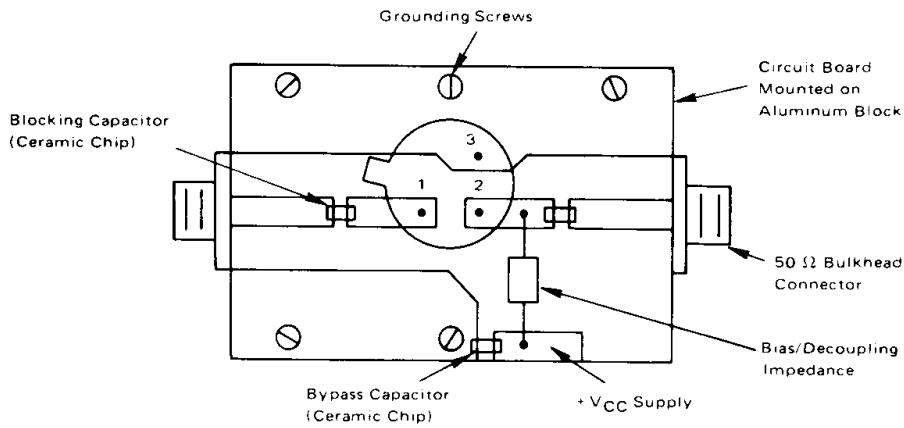

Note: The circuitry indicated is on the underside of the printed circuit board with sockets for the amplifier pins. The case of the amplifier should contact the printed circuit board top surface to ensure effective RF grounding.

Text Fixture

The 50 Ω input/output impedance levels of the MWA hybrids are most easily preserved on a circuit board by using 50 Ω microstrip transmission lines. Figure 28 is an example of a circuit board layout which utilizes microstrip transmission lines in conjunction with other sound RF construction techniques.

The characteristic impedance and corresponding line width of the microstrip are a function of the circuit board dielectric constant and thickness. The table lists appropriate line widths for 50 Ω microstrip lines on commonly used circuit board materials.

MATERIAL TYPE	DIELECTRIC CONSTANT	DIELECTRIC THICKNESS INCHES	LINE WIDTH INCHES
Teflon-Fiberglass	2.5	0.03125	0.090
		0.0625	0.180

As in all good RF circuit designs, care should be taken to minimize parasitic lead inductances and to provide adequate grounding.

FIGURE 29 — TYPICAL CASCADE

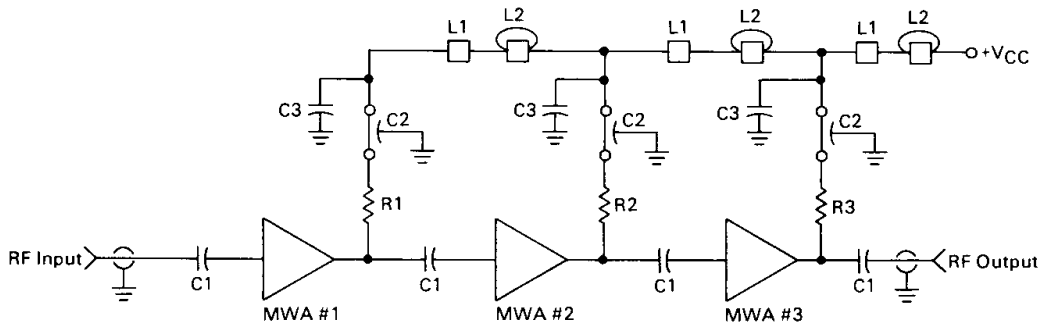

The dc isolation components shown are critical in maintaining good stability in multi-stage designs. Keep Pin #3 (Ground) as short as possible preferably soldering the case to the ground plane for best gain flatness to 1000 MHz.

- C1 — For operation to 400 MHz, 1000 pF, 50 mil Chip Capacitor — ATC 50 mil Case (5.0 MHz L.F.)
- C1 — For operation to 1000 MHz, 0.018 mF, Chip Capacitor for 0.25 MHz L.F. Cut-Off
- C2 — Feedthru Capacitor Centralab SFT-102, 1000 pF or Metuchen 54-794002-681M, 680 pF
- C3 — 0.1 μF Sprague 3CZ5U104X0050C5 — 50 Volt
- L1 — Ferroxcube Shielding Bead 56-590-65/4A — Single Wire
- L2 — Ferroxcube Shielding Bead 56-590-65/4A — 2 Turns #26 AWG

Cascading

The inherent stability of the MWA hybrid modules makes possible the cascading of two or more units with no oscillatory problems. Figure 29 shows a typical 3 hybrid cascade with measured data for 400 MHz and 1000 MHz hybrids.

	Cascade 1	Cascade 2
Frequency Range	0.25 to 400 MHz	5.0 to 1000 MHz
Gain	43.5 dB	20.5 dB
Gain Flatness	± 1.0 dB	± 0.75 dB
Input VSWR	2.0:1	2.4:1
Output VSWR	1.2:1	2.1:1
VCC Supply	12 Vdc	33 Vdc
I Supply	44 mAdc	150 mAdc
MWA #1	MWA110	MWA320
MWA #2	MWA110	MWA330
MWA #3	MWA120	MWA330
R1	1000 Ω	1000 Ω
R2	1000 Ω	500 Ω
R3	300 Ω	500 Ω