

TENTATIVE TOSHIBA BIPOLAR LINEAR INTEGRATED CIRCUIT SILICON MONOLITHIC

**TA7326P, TA7326F, TA7327P****CR TIMER****FEATURES**

- I<sup>2</sup>L IC with 12-stage binary counter.
- Built-in initialize circuit.
- Built-in Voltage regulator.
- Operates in both timer and oscillator modes.
- Excellent temperature stability.
- TA7327P has initial adjustment terminals of timing.

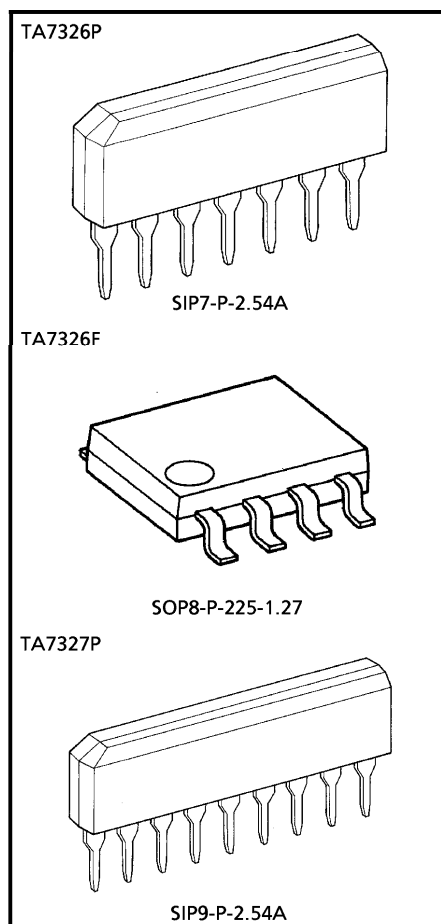

Weight	
SIP7-P-2.54A	: 0.7g (Typ.)
SOP8-P-225-1.27	: 0.1g (Typ.)
SIP9-P-2.54A	: 0.9g (Typ.)

980910EBA2

- TOSHIBA is continually working to improve the quality and the reliability of its products. Nevertheless, semiconductor devices in general can malfunction or fail due to their inherent electrical sensitivity and vulnerability to physical stress. It is the responsibility of the buyer, when utilizing TOSHIBA products, to observe standards of safety, and to avoid situations in which a malfunction or failure of a TOSHIBA product could cause loss of human life, bodily injury or damage to property. In developing your designs, please ensure that TOSHIBA products are used within specified operating ranges as set forth in the most recent products specifications. Also, please keep in mind the precautions and conditions set forth in the TOSHIBA Semiconductor Reliability Handbook.
- The products described in this document are subject to the foreign exchange and foreign trade laws.
- The information contained herein is presented only as a guide for the applications of our products. No responsibility is assumed by TOSHIBA CORPORATION for any infringements of intellectual property or other rights of the third parties which may result from its use. No license is granted by implication or otherwise under any intellectual property or other rights of TOSHIBA CORPORATION or others.
- The information contained herein is subject to change without notice.

BLOCK DIAGRAM

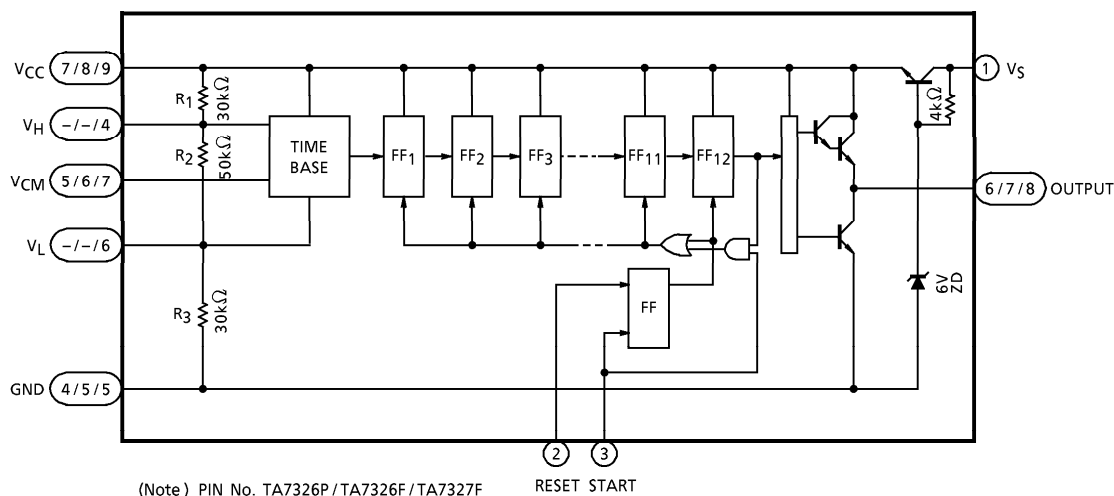

PIN CONNECTION

PIN No.	CONNECTION		
	TA7326P	TA7326F	TA7327F
1	V <sub>S</sub>	V <sub>S</sub>	V <sub>S</sub>
2	RESET	RESET	RESET
3	START	START	START
4	GND	N.C.	V <sub>H</sub>
5	V <sub>CM</sub>	GND	GND
6	OUTPUT	V <sub>CM</sub>	V <sub>L</sub>
7	V <sub>CC</sub>	OUTPUT	V <sub>CM</sub>
8	—	V <sub>CC</sub>	OUTPUT
9	—	—	V <sub>CC</sub>

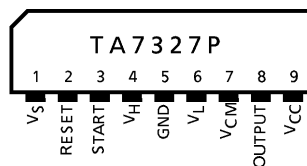
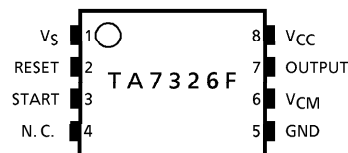
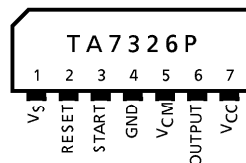

TRUTH TABLE

MODE	INPUTS		OUTPUT
	RESET	START	
1	H	(*)	L
2	L	H	COUNT, OSCILLATOR MODE
3	L	H	HOLD "H", TIMER MODE
4	L	L	HOLD LAST STATE

(\*) H or L  
Output equal "L" when power on.

TIMING CHART

- Timer mode

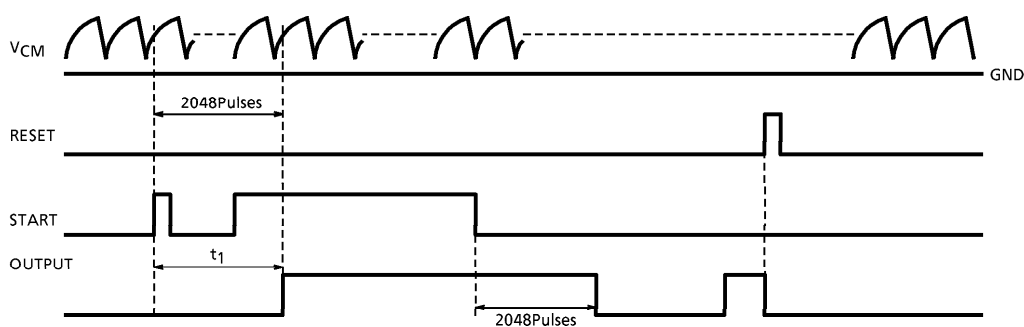

- Oscillator mode

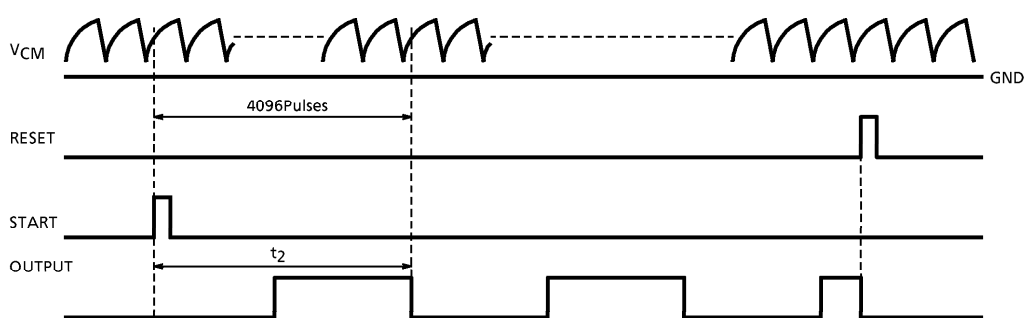

## MAXIMUM RATINGS (Ta = 25°C)

CHARACTERISTIC		SYMBOL	RATING	UNIT
Supply Voltage		V <sub>S</sub>	12	V
Supply Voltage		V <sub>CC</sub>	7	V
Input Voltage		V <sub>IH</sub>	20	V
Output Current		I <sub>OH</sub>	-30	mA
		I <sub>OL</sub>	2	
Power Dissipation (Note)	TA7326P, TA7326F	P <sub>D</sub>	400	mW
	TA7327P		600	
Operating Temperature		T <sub>opr</sub>	-20 ~ 75	°C
Storage Temperature		T <sub>stg</sub>	-55 ~ 125	°C

(Note) Derated above Ta = 25°C in the proportion of 4mW/°C for TA7326P and 6mW/°C for TA7327P.

## ELECTRICAL CHARACTERISTICS (Ta = 25°C)

CHARACTERISTIC		SYMBOL	TEST CIRCUIT	TEST CONDITION	MIN.	TYP.	MAX.	UNIT
Supply Voltage		V <sub>S</sub>	—	Ta = -20 ~ 75°C	7	—	12	V
Supply Voltage		V <sub>CC</sub>	1	V <sub>S</sub> = 7 ~ 12V, I <sub>CC</sub> = 6mA	5.0	—	6.3	V
Supply Current		I <sub>S</sub>	2	V <sub>S</sub> = 12V	—	2	5	mA
Input Bias Current		I <sub>I</sub>	3	V <sub>CC</sub> = 5.7V	—	—	0.35	μA
Input Voltage	"H" Level	V <sub>IH</sub>	4	V <sub>CC</sub> = 5.7V	2.5	—	—	V
	"L" Level	V <sub>IL</sub>	4	V <sub>CC</sub> = 5.7V	—	—	1.5	V
Input Current	"H" Level	I <sub>IH</sub>	4	V <sub>CC</sub> = 5.7V, V <sub>IH</sub> = 2.5V	—	—	0.25	mA
	"L" Level	I <sub>IL</sub>	4	V <sub>CC</sub> = 5.7V, V <sub>IL</sub> = 0V	—	—	-1	μA
Output Voltage	"H" Level	V <sub>OH</sub>	5	V <sub>CC</sub> = 5.7V, I <sub>OH</sub> = -30mA	3.5	—	—	V
	"L" Level	V <sub>OL</sub>	6	V <sub>CC</sub> = 5.7V, I <sub>OH</sub> = 1mA	—	—	0.3	V
Temperature Coefficient of V <sub>CC</sub>		ΔV <sub>CC</sub> / ΔTa	—	V <sub>S</sub> = 10V, Ta = -20 ~ 75°C	—	5	—	mV / °C
Temperature Coefficient of Timing		Δt / ΔTa	—	V <sub>CC</sub> = 5.7V, Ta = -20 ~ 75°C, C <sub>t</sub> = 100 μF, R <sub>t</sub> = 10kΩ	—	200	—	ppm / °C
Timing Drift with Supply Voltage Ratio		Δt / ΔV <sub>CC</sub>	—	V <sub>CC</sub> = 5.0 ~ 6.3V, C <sub>t</sub> = 100 μF, R <sub>t</sub> = 10kΩ	—	0.5	—	% / V
Timing Resistance		R <sub>t</sub>	—	—	1	—	1000	kΩ

TEST CIRCUIT

1.  $V_{CC}$

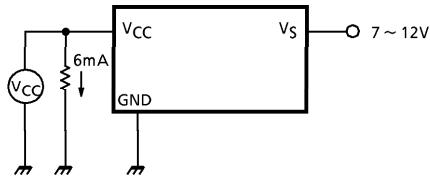

4.  $V_{IH}$ ,  $V_{IL}$ ,  $I_{IH}$ ,  $I_{IL}$

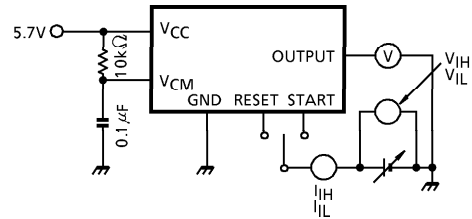

2.  $I_S$

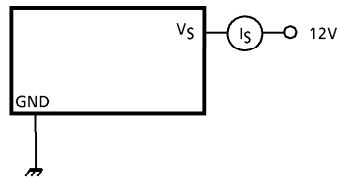

5.  $V_{OH}$

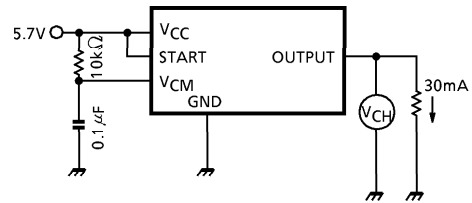

3.  $I_I$

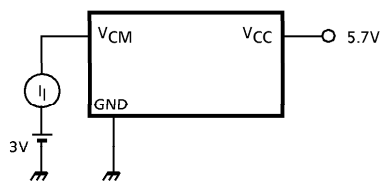

6.  $V_{OL}$

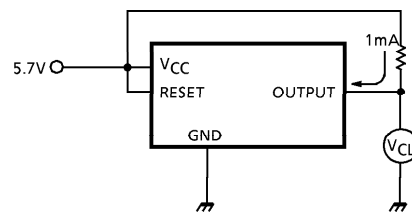

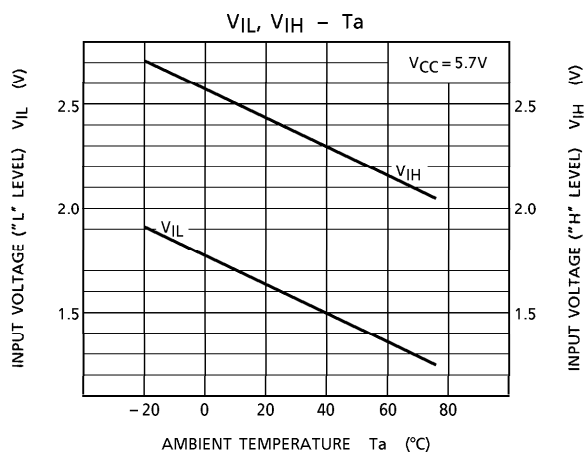
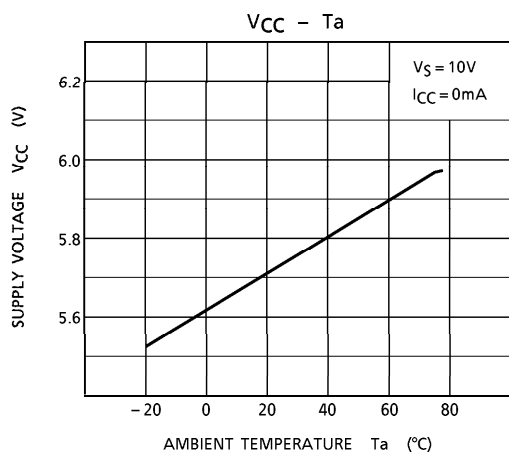
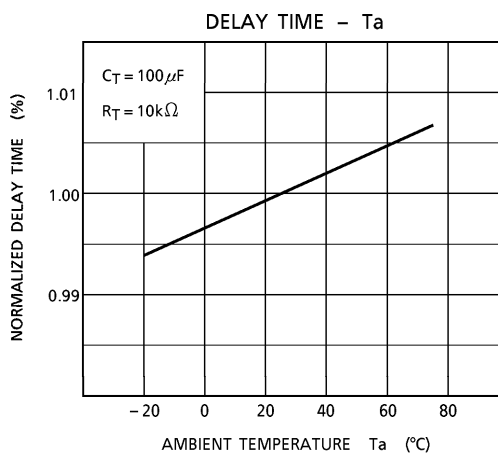
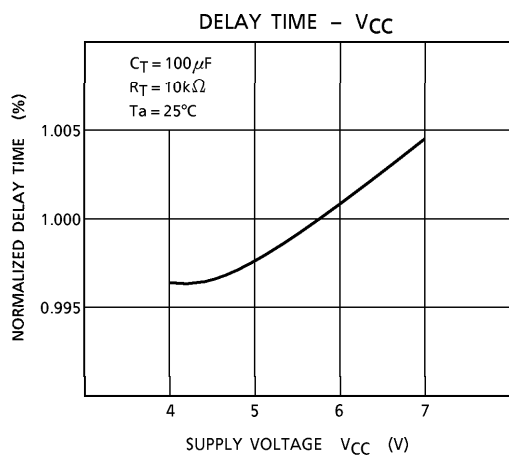
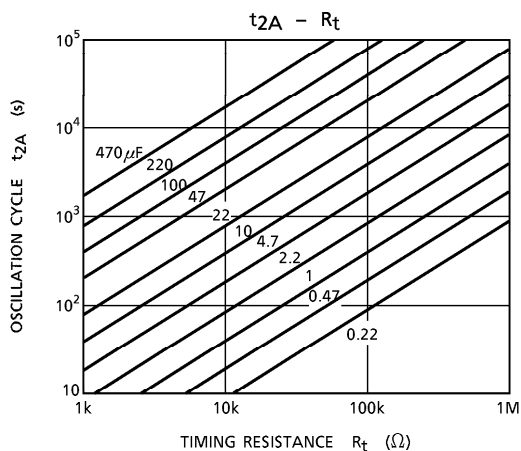
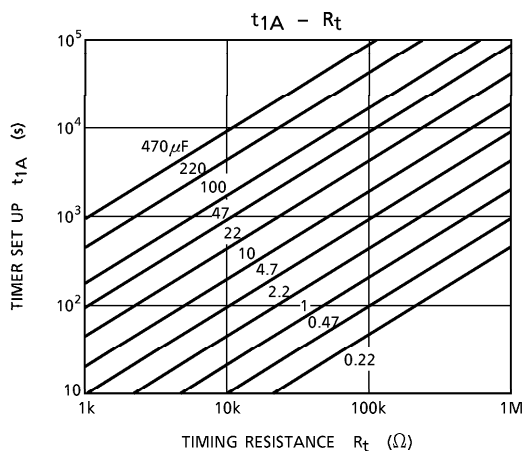

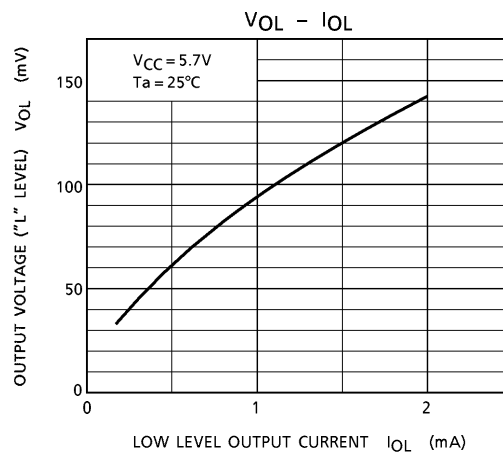
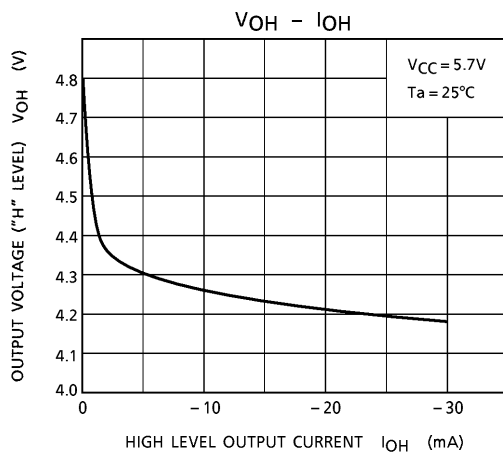
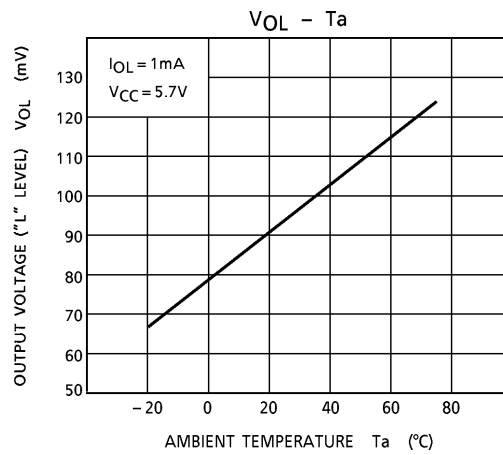
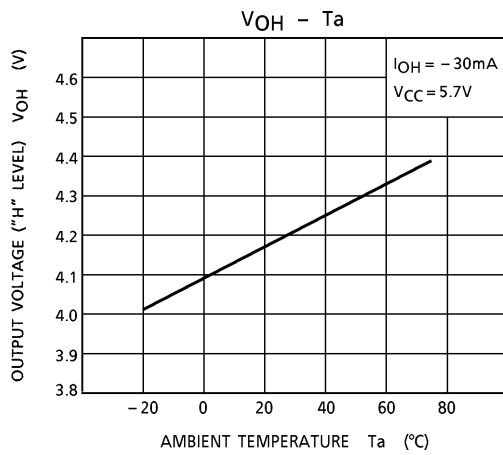
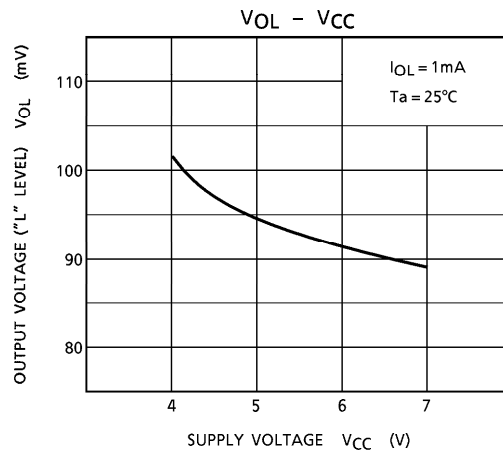
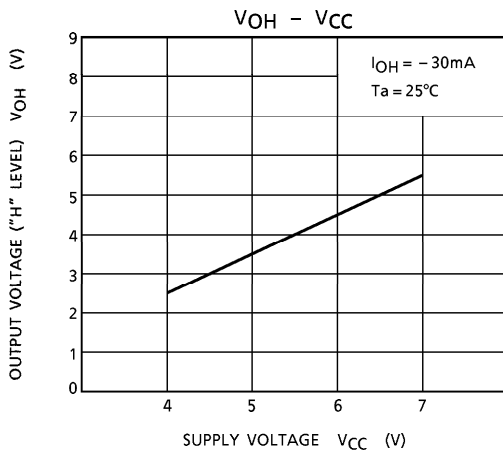

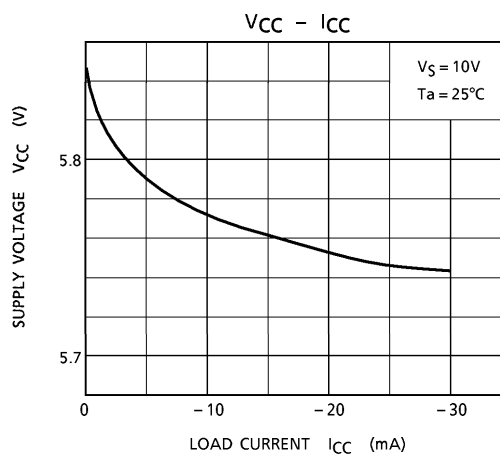
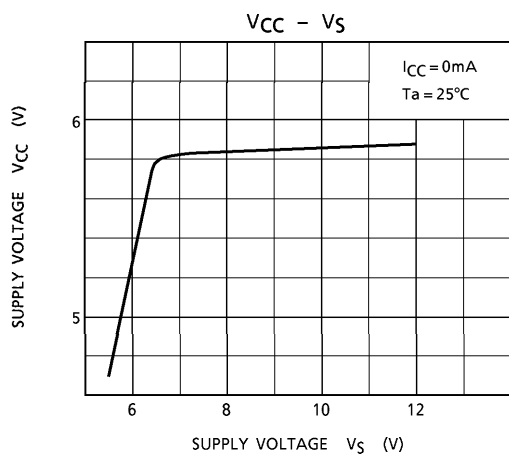



APPLICATION CIRCUIT (Ta = 25°C)

Timer mode

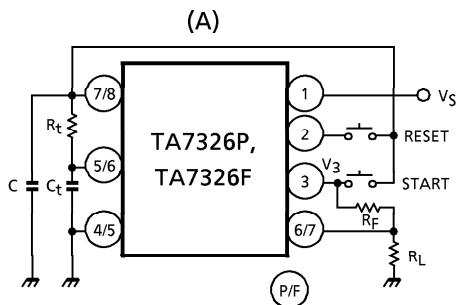

$C = 1 \sim 10 \mu\text{F}$   
 $V_3 > V_{IH}$   
 $t_{1A} \approx 2048 C_t \cdot R_t \text{ (s)}$   
 $C_t : \text{(F)}$   
 $R_t : \text{(\Omega)}$

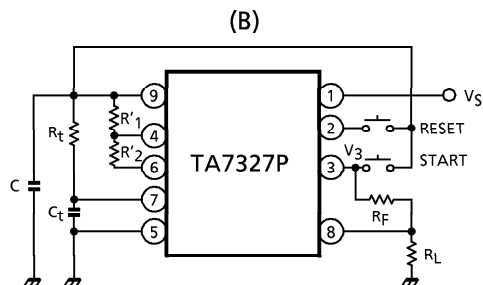

$C = 1 \sim 10 \mu\text{F}$   
 $V_3 > V_{IH}, V_H < V_{CC} - 1\text{V}, V_L > 1.2\text{V}$   
 $t_{1B} = 2048 C_t \cdot R_t \left| \ln \frac{r_1}{r_1 + r_2} \right| \text{ (s)}$   
 $C_t : \text{(F)}$   
 $R_t : \text{(\Omega)}$   
 $r_1 = R_1 // R'_1, R_1 = 30\text{k}\Omega$   
 $r_2 = R_2 // R'_2, R_2 = 50\text{k}\Omega$

Oscillator mode

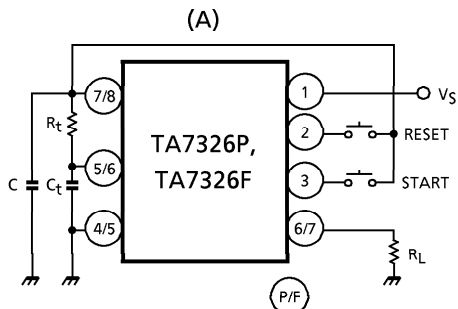

$C = 1 \sim 10 \mu\text{F}$   
 $t_{2A} \approx 4096 C_t \cdot R_t \text{ (s)}$   
 $C_t : \text{(F)}$   
 $R_t : \text{(\Omega)}$

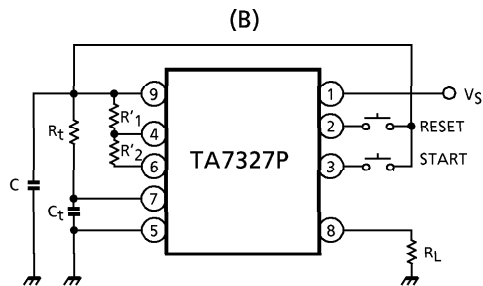

$C = 1 \sim 10 \mu\text{F}$   
 $V_H < V_{CC} - 1\text{V}, V_L > 1.2\text{V}$   
 $t_{2B} = 4096 C_t \cdot R_t \left| \ln \frac{r_1}{r_1 + r_2} \right| \text{ (s)}$   
 $C_t : \text{(F)}$   
 $R_t : \text{(\Omega)}$   
 $r_1 = R_1 // R'_1, R_1 = 30\text{k}\Omega$   
 $r_2 = R_2 // R'_2, R_2 = 50\text{k}\Omega$

**OUTLINE DRAWING**  
SIP7-P-2.54A

Unit : mm

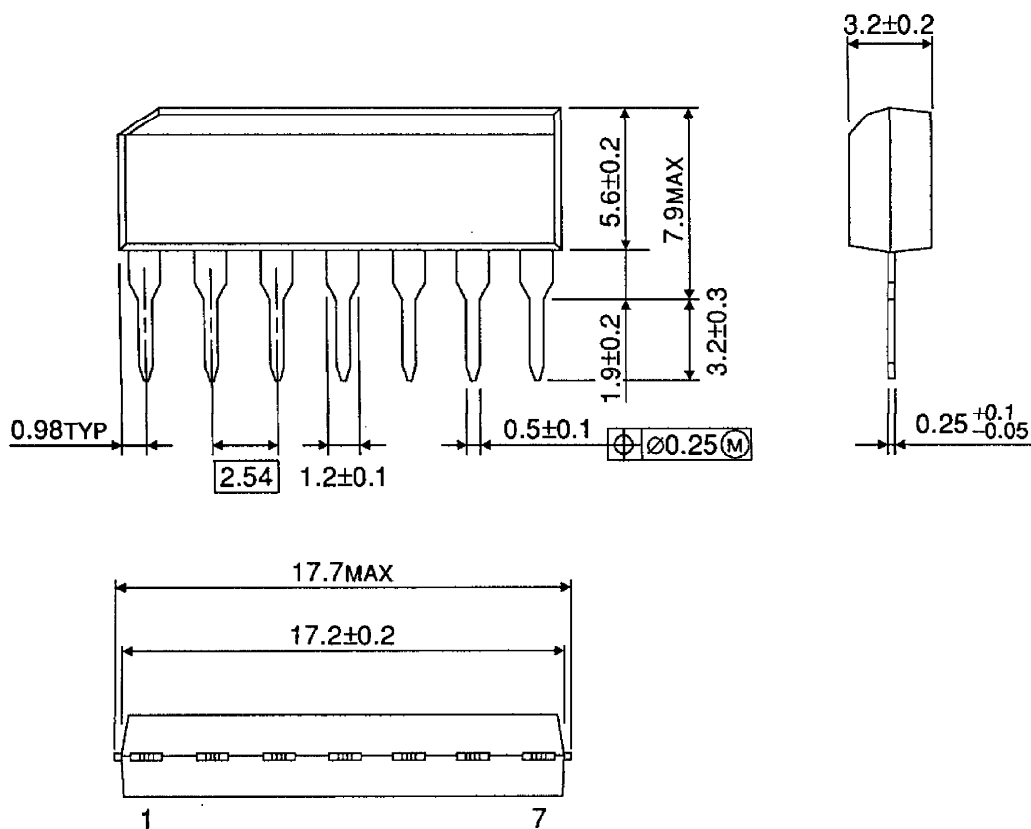

Weight : 0.7g (Typ.)

OUTLINE DRAWING  
SOP8-P-225-1.27

Unit : mm

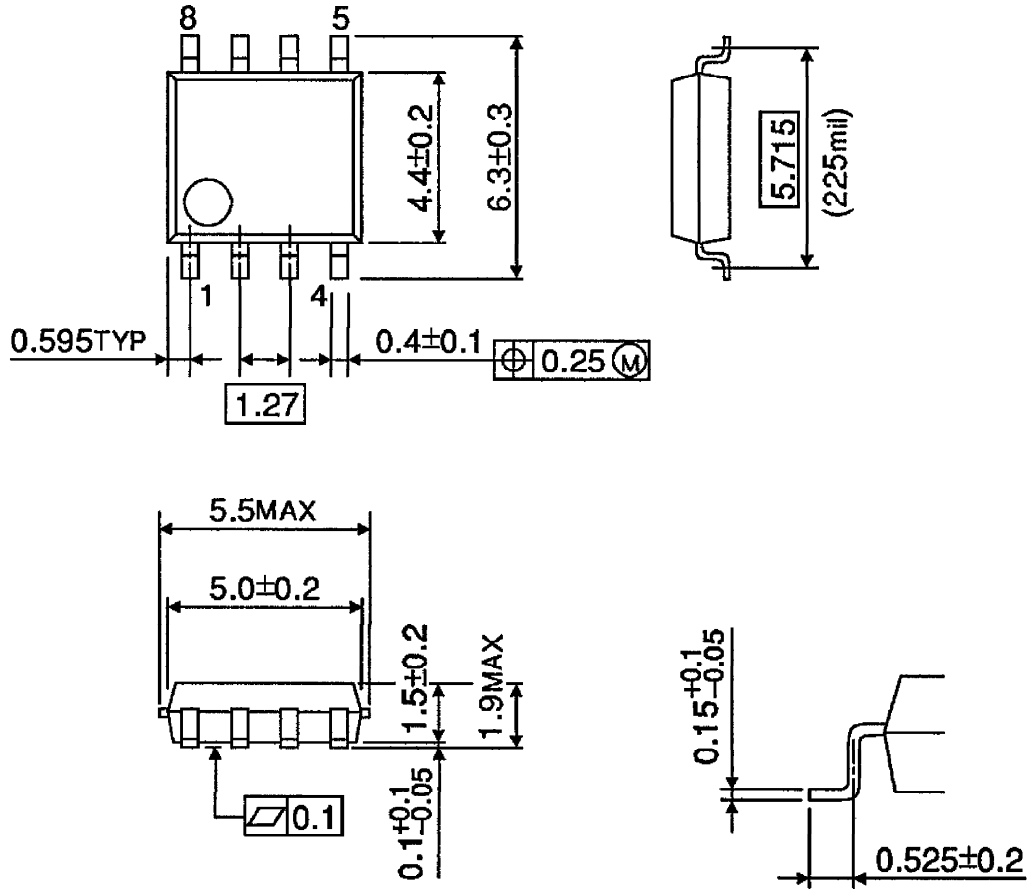

Weight : 0.1g (Typ.)

**OUTLINE DRAWING**  
SIP9-P-2.54A

Unit : mm

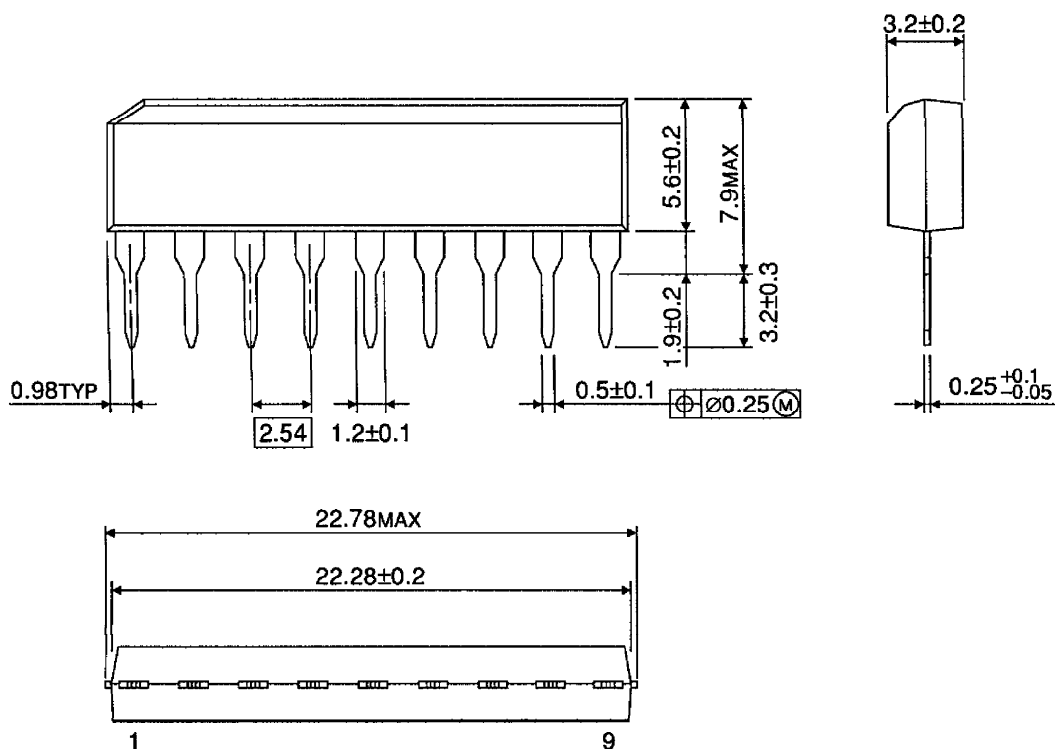

Weight : 0.9g (Typ.)