

# High Dynamic Range Low Noise Amplifier

## 1400 - 2000 MHz

**AM50-0004**

V2.00

### Features

- Low Noise Figure: 1.4 dB
- High Input IP3: +18 dBm at 8 V, 45 mA bias  
+8 dBm at 3V, 20 mA bias
- High Gain: 14 dB
- Single Supply: +3 to +8 VDC
- Low Cost SOIC-8 Plastic Package
- Adjustable current: 20 to 60 mA with external resistor

### Description

M/A-COM's AM50-0004 is a high dynamic range, GaAs MMIC, low noise amplifier in a low cost, SOIC 8-lead, surface mount, plastic package. It employs external input matching to obtain optimum noise figure performance and operating frequency flexibility. The AM50-0004 also features flexible biasing to control the current consumption vs. dynamic range trade-off. The AM50-0004 can operate from any positive supply voltage in the 3 V to 8 V range. Its current can be controlled over a range of 20 mA to 60 mA with an external resistor.

The AM50-0004 is ideally suited for use where low noise figure, high gain, high dynamic range, and low power consumption are required. Typical applications include receiver front ends in PDC, DCS-1800, DCS-1900 and other PCN/PCS base stations. It is also useful as a gain block, buffer, driver and IF amplifier in both fixed or portable PDC and PCN/PCS systems.

The AM50-0004 is fabricated using a low-cost 0.5-micron gate length GaAs process. The process features full passivation for increased performance and reliability. The AM50-0004 is 100% RF tested to ensure performance specification compliance.

### SO-8

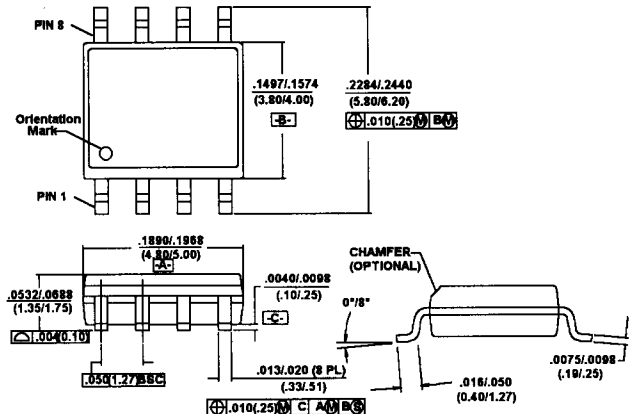

### Ordering Information

Part Number	Package
AM50-0004	SOIC 8-Lead Plastic
AM50-0004TR	Forward Tape and Reel*
AM50-0004RTR	Reverse Tape and Reel*
AM50-0004SMB	Designer's Kit

\* If specific reel size is required, consult factory for part number assignment.

### Electrical Specifications<sup>1</sup>: $T_A = +25^\circ\text{C}$ , $Z_0 = 50 \Omega$ , $F = 1785 \text{ MHz}$ , $P_{IN} = -30 \text{ dBm}$

Parameter	Test Conditions	Units	Min.	Typ.	Max.
Gain	5 V, 45 mA <sup>2</sup>	dB	12.0	14	
	3 V, 20 mA	dB		12.5	
Noise Figure	5 V, 45 mA <sup>2</sup>	dB		1.4	1.8
	3 V, 20 mA	dB		1.5	
Input VSWR				1.5:1	
Output VSWR				2.0:1	
Output 1 dB Compression	5 V, 45 mA <sup>2</sup>	dBm		16.0	
	3 V, 20 mA	dBm		9.0	
Input IP3	5 V, 45 mA <sup>2</sup>	dBm	13.0	15	
	3 V, 20 mA	dBm		8.0	
Reverse Isolation		dB		22	
Drain Current	5 V, 45 mA <sup>2</sup>	mA	30	45	60

1: See page 3 for performance versus frequency and bias.

2: Using external 15  $\Omega$  resistor. See functional block diagram on page 2.

Specifications Subject to Change Without Notice.

**M/A-COM, Inc.**

North America: Tel. (800) 366-2266  
Fax (800) 618-8883

♦ Asia/Pacific: Tel. +81 3 3263-8761  
Fax +81 3 3263-8769

♦ Europe: Tel. +44 (1344) 869-595  
Fax +44 (1344) 300-020

**Absolute Maximum Ratings**<sup>1</sup>

Parameter	Absolute Maximum
V <sub>DD</sub>	+10 VDC
Input Power	+17 dBm
Current <sup>2</sup>	80 mA
Channel Temperature <sup>3</sup>	+150°C
Operating Temperature	-40°C to +85°C
Storage Temperature	-65°C to +150°C

1. Exceeding any one or combination of these limits may cause permanent damage.
2. When pin #2 is used to increase current. (See note 5.)
3. Thermal resistance (θ<sub>jc</sub>) = +99°C/W.

**Functional Block Diagram**

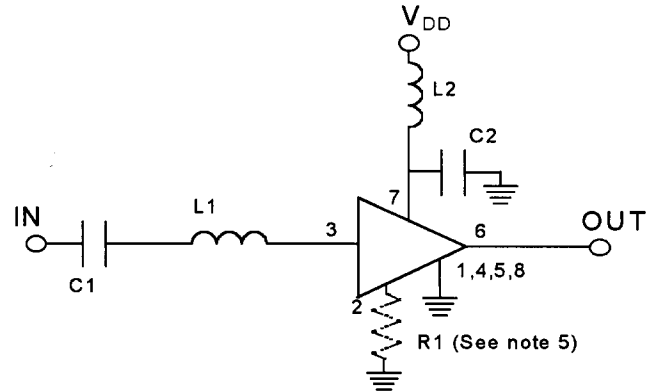

**Pin Configuration**

Pin No.	Pin Name	Description
1	GND	RF and DC Ground
2	R <sub>EXT</sub>	External Current Control (optional)
3	IN	RF Input of the amplifier
4	GND	RF and DC Ground
5	GND	RF and DC Ground
6	OUT	RF Output of the amplifier
7	V <sub>DD</sub>	Positive supply voltage
8	GND	RF and DC Ground

**External Circuitry Parts List**<sup>4</sup>

Part	Value	Purpose
C1	47 pF	DC Block
C2	47 pF	By-Pass
L1	3.9 nH	Tuning
L2	12 nH	RF Choke
R1	see note 5	Optional current control

4. All external circuitry parts are readily available, low cost surface mount components (.060 in. x .030 in. or .080 in. x .050 in.).
5. Pin 2 allows use of an external resistor to ground for optional, higher current. For 20 mA operation, no resistor is used.  
 For I<sub>DD</sub> ~ 30 mA, R1 = 39 ohms;  
 I<sub>DD</sub> ~ 45 mA, R1 = 15 ohms;  
 I<sub>DD</sub> ~ 60 mA, R1 = 6 ohms.

**Recommended PCB Configuration**

**Layout View**

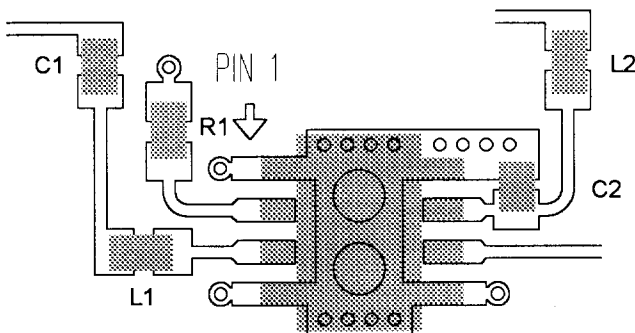

**Cross Section View**

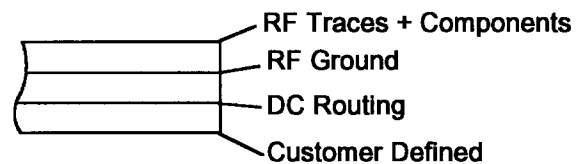

The PCB dielectric between RF traces and RF ground layers should be chosen to reduce RF discontinuities between 50 Ω lines and package pins. M/A-COM recommends an FR-4 dielectric thickness of 0.008" (0.20 mm) yielding a 50 Ω line width of 0.015" (0.38 mm). The recommended RF metalization is 1 ounce copper.

Specifications Subject to Change Without Notice.

Typical Performance Data (when matched as shown on page 2)

Test Conditions:  $T_A = +25^\circ\text{C}$ ,  $Z_0 = 50 \Omega$ ,  $V_{DD} = 5 \text{ V}$ ,  $I_{DD} = 45 \text{ mA}$  unless otherwise specified.

GAIN vs. FREQUENCY

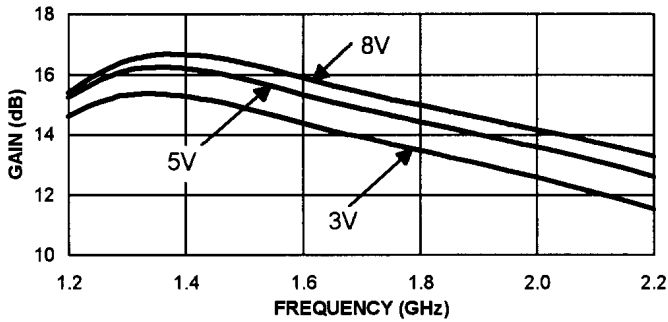

VSWR vs. FREQUENCY

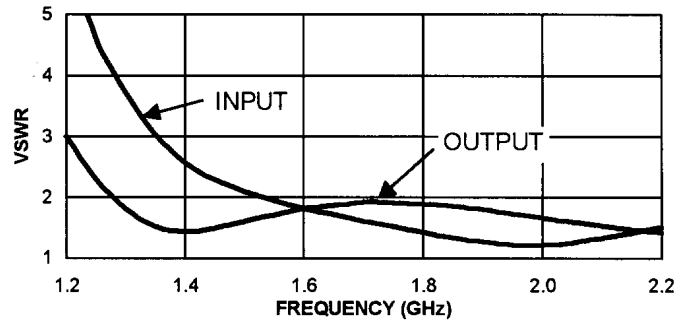

NOISE FIGURE vs. FREQUENCY

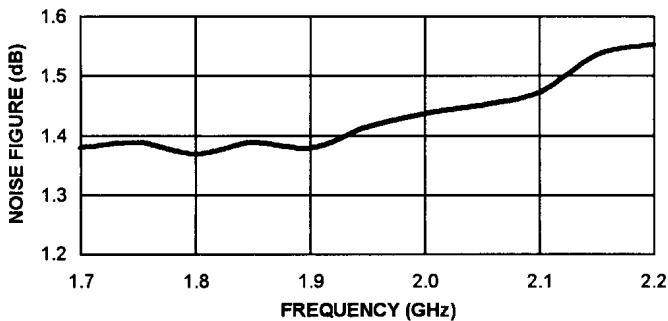

NOISE FIGURE vs. CURRENT, F=1785 MHz

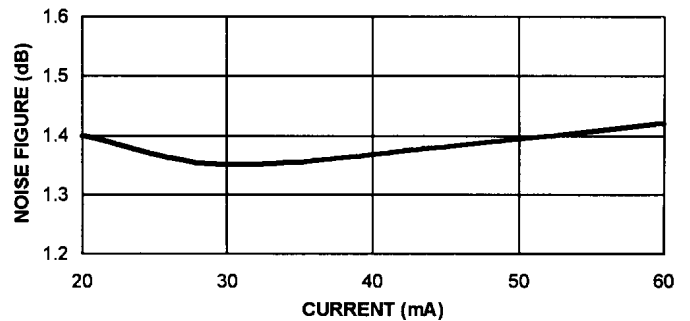

OUTPUT P1dB vs. FREQUENCY

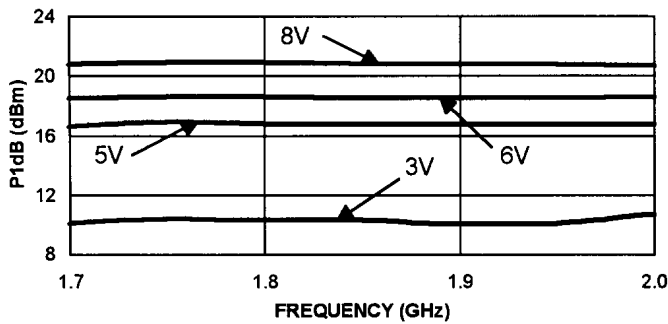

OUTPUT P1dB vs. CURRENT, F=1785 MHz

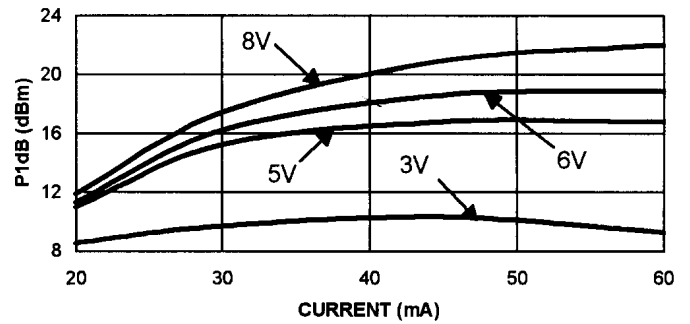

INPUT IP3 vs. FREQUENCY

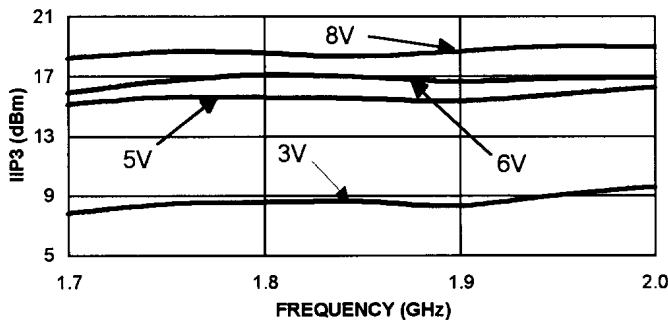

INPUT IP3 vs. CURRENT, F=1785 MHz

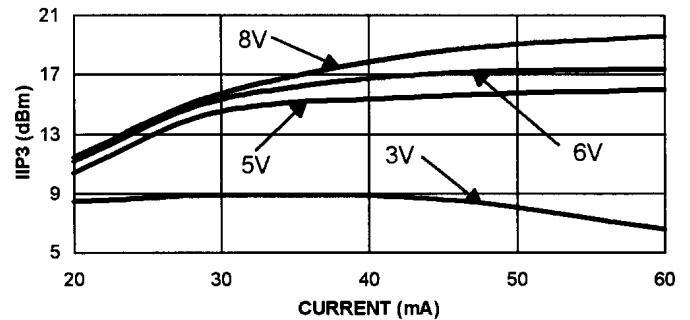

Specifications Subject to Change Without Notice.

M/A-COM, Inc.

North America: Tel. (800) 366-2266  
Fax (800) 618-8883

Asia/Pacific: Tel. +81 3 3263-8761  
Fax +81 3 3263-8769

Europe: Tel. +44 (1344) 869-595  
Fax +44 (1344) 300-020

Typical Performance Data continued (when matched as shown on page 2)

Test Conditions:  $Z_0 = 50 \Omega$ ,  $V_{DD} = 5 \text{ V}$ ,  $I_{DD} = 45 \text{ mA}$  unless otherwise specified.

GAIN vs. TEMPERATURE

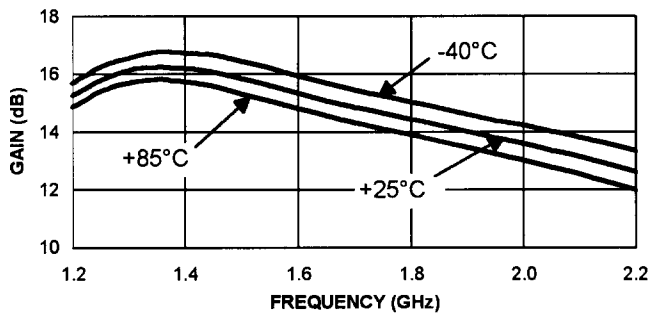

NOISE FIGURE vs. TEMPERATURE

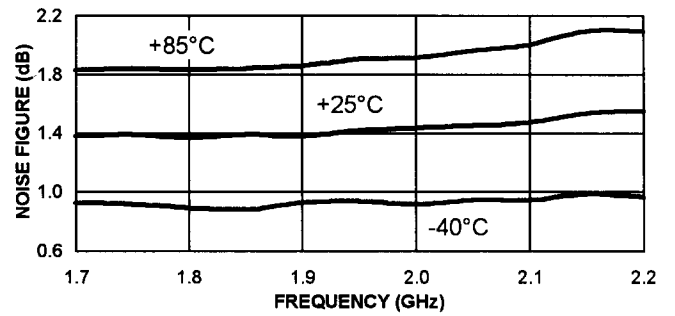

Designer's Kit AM50-0004SMB

The AM50-0004SMB Designer's Kit allows for immediate evaluation of M/A-COM's AM50-0004. The Designer's Kit includes an AM50-0004, an evaluation board, and a floppy disk containing typical performance data and a DXF file of the recommended PCB layout.

The evaluation board consists of the recommended external surface mount circuitry, RF connectors, and a DC multi-pin connector, all mounted to a multi-layer FR-4 PCB. The AM50-0004SMB evaluation PCB is illustrated below with all functional ports labeled.

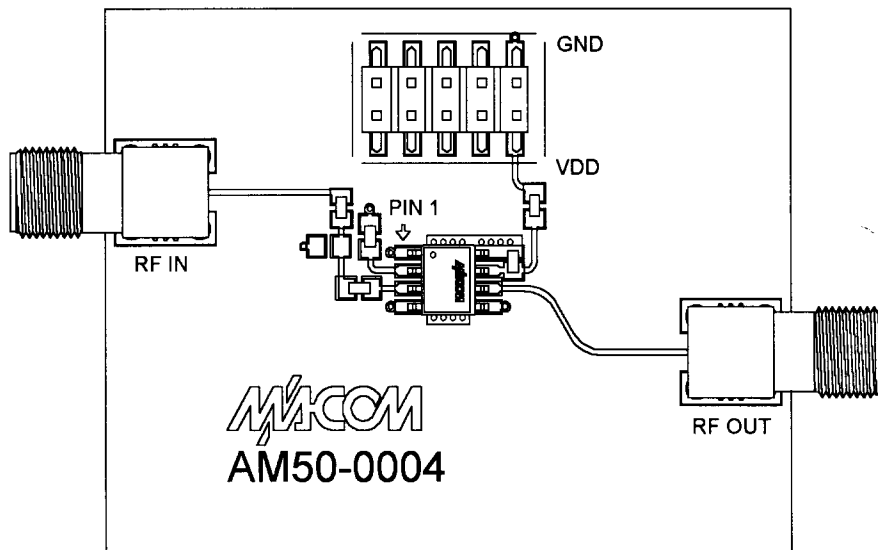

AM50-0004 EVALUATION BOARD

Evaluation PCB + RF Connector Losses

Port Reference	Approximate RF Loss
RF IN	0.15 dB @ 1785 MHz
RF OUT	0.15 dB @ 1785 MHz

The DC connector on the Designer's Kit PCB allows convenient DC line access. This is accomplished by one or more of the following methods:

1. A mating female multi-pin connector (Newark Electronics Stock # 46F-4658, not included).
2. Wires soldered to the necessary pins (not included).
3. Clip leads (not included).

Specifications Subject to Change Without Notice.