

FEATURES

- HIGH FREQUENCY OPERATION TO 2.8 GHz
- WIDE BAND OPERATION
- SINGLE SUPPLY VOLTAGE: $V_{CC} = 5\text{ V} \pm 10\%$
- COMPLEMENTARY OUTPUTS

DESCRIPTION

The UPB582 series of devices are divide-by-4 silicon bipolar digital prescalers. They feature high frequency response and operate from a single 5 volt supply. The series is available in three package styles: 8 pin can (UPB582A); 8 lead ceramic flat package (UPB582B) and an 8 pin DIP (UPB582C). Applications include: frequency synthesizers, division and prescaling.

TEST CIRCUITS

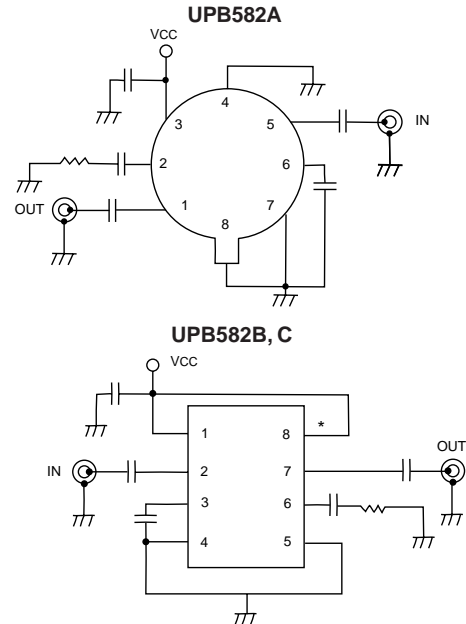

Note: All capacitors are 2200 pF, all resistors are 50 ohms.
* Pin 8 is not connected for UPB582C.

ELECTRICAL CHARACTERISTICS ($V_{CC} = 5.0 \pm 0.5\text{ V}$, $Z_s = Z_L = 50\ \Omega$)

PART NUMBER PACKAGE OUTLINE			UPB582A A08			UPB582B BF08			UPB582C C08		
SYMBOLS	PARAMETERS AND CONDITIONS	UNITS	MIN	TYP	MAX	MIN	TYP	MAX	MIN	TYP	MAX
I _{CC}	Power Supply Current	mA	25	45	60	25	45	60	25	45	60
f _{IN}	Frequency Response at P _{IN} = -10 to -5 dBm ¹ P _{IN} = -5 to 0 dBm ¹ P _{IN} = 0 to +5 dBm ¹ P _{IN} = -2 to +10 dBm ² P _{IN} = +3 to +10 dBm ² P _{IN} = -5 to +10 dBm ³ P _{IN} = -5 to +10 dBm ⁴ P _{IN} = -3 to +10 dBm ⁵	GHz GHz GHz GHz GHz GHz GHz GHz				0.5 0.5 0.5		2.4 2.6 2.8			
P _{IN}	Input Power at f _{IN} = 0.5 to 2.4 GHz ¹ f _{IN} = 0.5 to 2.6 GHz ¹ f _{IN} = 0.5 to 2.8 GHz ¹ f _{IN} = 0.5 to 2.6 GHz ² f _{IN} = 0.5 to 2.8 GHz ² f _{IN} = 0.5 to 2.2 GHz ³ f _{IN} = 0.5 to 2.4 GHz ⁴ f _{IN} = 0.5 to 2.4 GHz ⁵	dBm dBm dBm dBm dBm dBm dBm dBm									
P _{OUT}	Output Power ⁶	dBm	-12	-8		-12	-8		-12	-8	
R _{TH} (J-C)	Thermal Resistance, Junction to Case (UPB582B)	°C/W						20			

Notes:

1. T_A = -40 to +85°C.
2. T_A = -20 to +75°C.
3. T_A = -35 to +85°C.
4. T_A = -20 to +65°C, V_{CC} = 5.0 ± 0.25 V.
5. T_A = -20 to +70°C, V_{CC} = 5.0 ± 0.25 V.
6. T_A = +25°C, f_{IN} = 2.0 GHz, P_{IN} = 0 dBm.

ABSOLUTE MAXIMUM RATINGS¹ (T_A = 25°C)

SYMBOLS	PARAMETERS	UNITS	RATINGS
V _{CC}	Supply Voltage	V	-0.5 to 6.0
V _{IN}	Input Voltage	V	-0.5 to V _{CC} +0.5
P _{IN}	Input Power	dBm	+10
P _D	Total Power Dissipation		
	UPB582B ²	mW	1500
	UPB582A	mW	750
	UPB582C	mW	600
T _{OP}	Operating Temperature		
	UPB582B	°C	-55 to +125
	UPB582A, C	°C	-55 to +85
T _{STG}	Storage Temperature		
	UPB582B	°C	-65 to +200
	UPB582A	°C	-55 to +200
	UPB582C	°C	-55 to +125

Notes

1. Operation in excess of any one of these parameters may result in permanent damage.
2. T_A = Absolute Maximum Operating Temperature.

RECOMMENDED OPERATING CONDITIONS (T_A = 25°C)

SYMBOL	PARAMETER	UNITS	RATINGS
V _{CC}	Supply Voltage	V	4.5 to 5.5
T _{OP}	Operating Temperature		
	UPB582B	°C	-40 to +85
	UPB582A, C	°C	-20 to +75

Note: Because of the high internal gain and gain compression of the UPB582, this device is prone to self-oscillation in the absence of an RF input signal. If the device will be used in an application where DC power will be applied in the absence of an RF input signal, this self-oscillation can be suppressed by any of the following means:

- * Add a shunt resistor from the RF input line to ground. The blocking capacitor should be between the resistor and the UPB582, but physical separation should be minimized. Typically a resistor value between 50 and 100 ohms will suppress the self-oscillation.
- * Apply a DC offset voltage of +3.0 volts to the INPUT pin. The voltage source should be isolated from the INPUT pin by a series 1000 ohm resistor.
- * Apply a DC offset voltage of +1.5 volts to the BYPASS pin. The voltage source should be isolated from the BYPASS pin by a series 1000 ohm resistor.

All these approaches reduce the input sensitivity of the UPB582 (by as much as 3 dB for the example of a 50 ohm shunt resistor), but otherwise have no effect on the reliability or other electrical characteristics of this device.

TYPICAL PERFORMANCE CURVES

(V_{CC} = 5 V, T_A = 25°C)

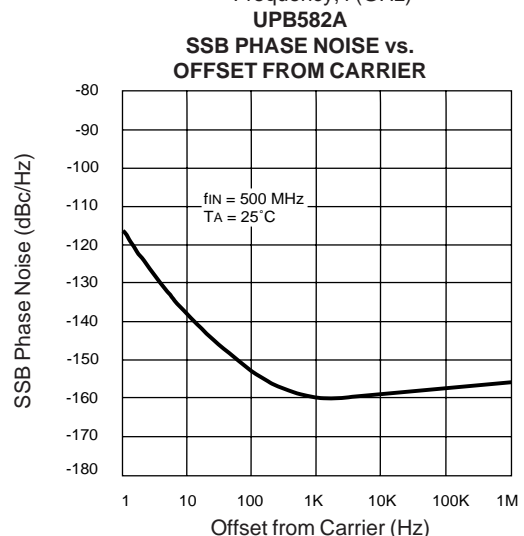
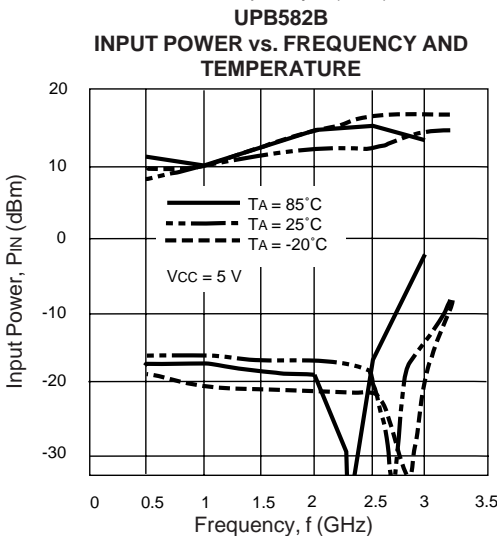
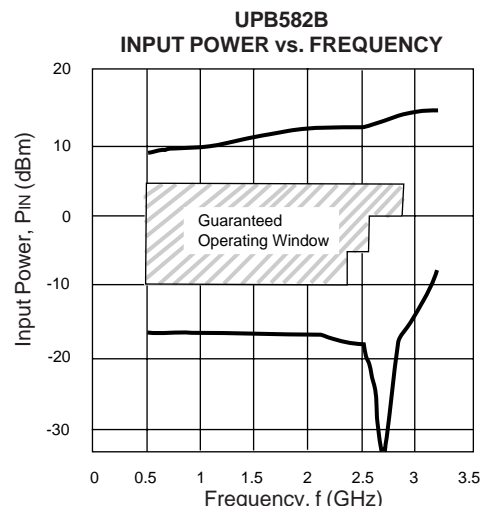
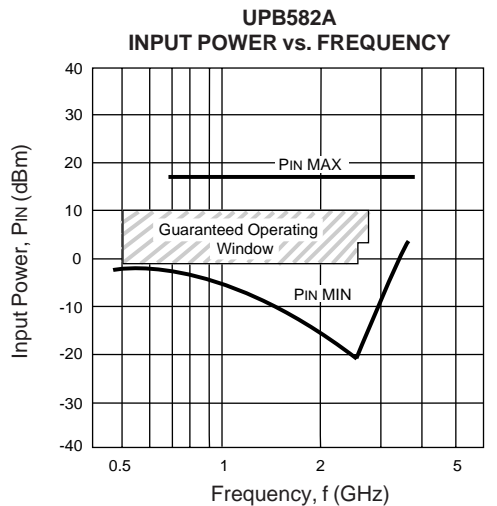

TYPICAL PERFORMANCE CURVES (TA = 25°C unless otherwise noted)

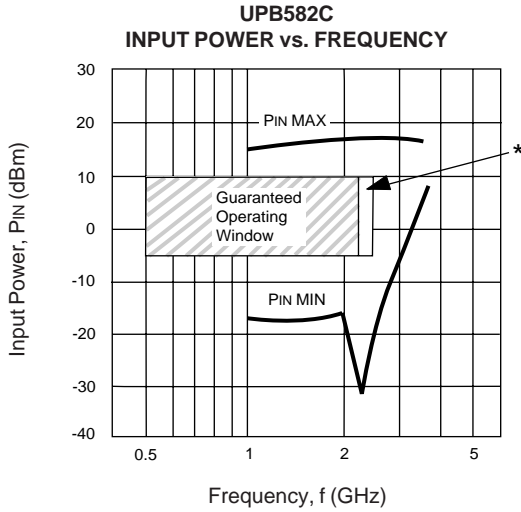

*See special conditions in Electrical Characteristics Table.

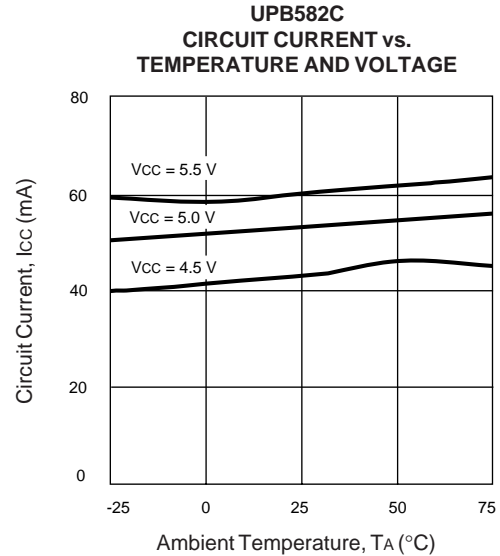
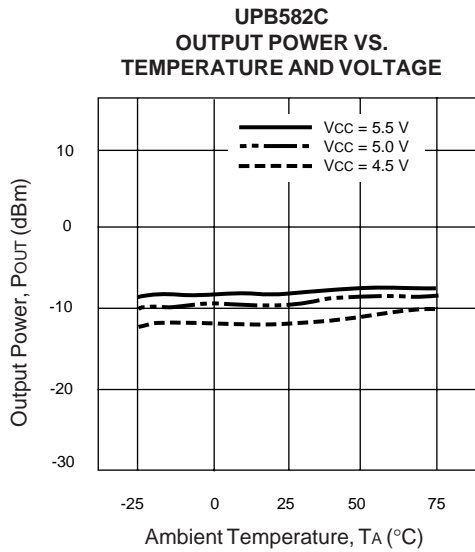
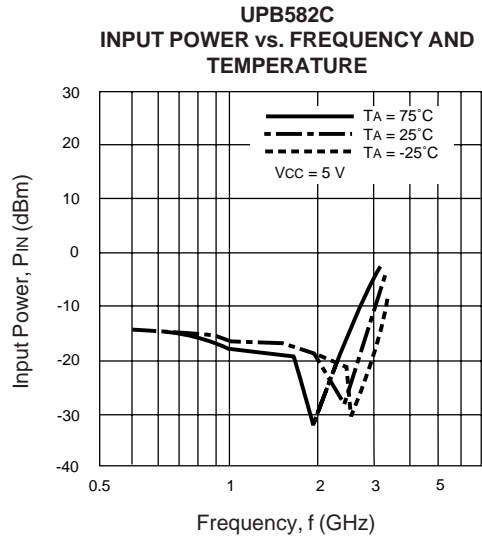

UPB582C INPUT AND OUTPUT S-PARAMETERS

VCC = 5.0 V, ICC = 45 mA

Frequency (GHz)	S11		Frequency (GHz)	S22	
	MAG	ANG		MAG	ANG
0.20	0.079	142	0.10	0.329	142
0.40	0.246	119	0.20	0.395	104
0.80	0.231	100	0.30	0.452	79
1.20	0.334	91	0.40	0.482	59
1.60	0.422	84	0.50	0.484	45
2.00	0.553	75	0.60	0.466	36
2.40	0.645	63	0.70	0.460	31
2.80	0.690	49	0.80	0.474	26
3.20	0.674	33	0.90	0.481	20

OUTLINE DIMENSIONS (Units in mm)

UPB582A
PACKAGE OUTLINE A08

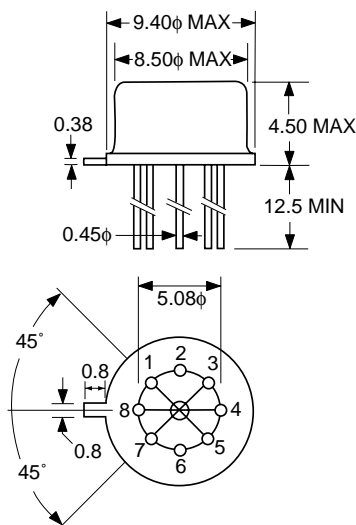

- PIN CONNECTIONS
- 1. Output 1
 - 2. Output 2
 - 3. Vcc
 - 4. GND
 - 5. Input
 - 6. Bypass
 - 7. GND
 - 8. GND

UPB582B
PACKAGE OUTLINE BF08

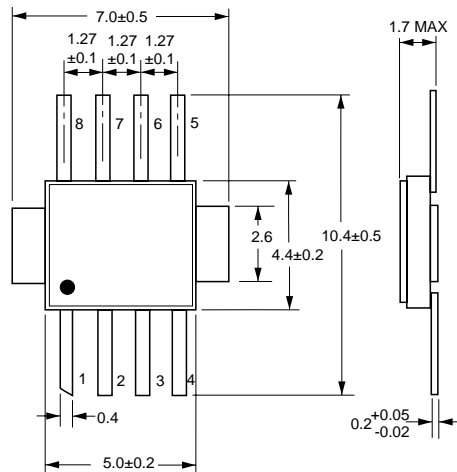

- PIN CONNECTIONS
- 1. Vcc
 - 2. Input
 - 3. Bypass
 - 4. GND
 - 5. GND
 - 6. Output 1
 - 7. Output 2
 - 8. Vcc

UPB582C
PACKAGE OUTLINE C08

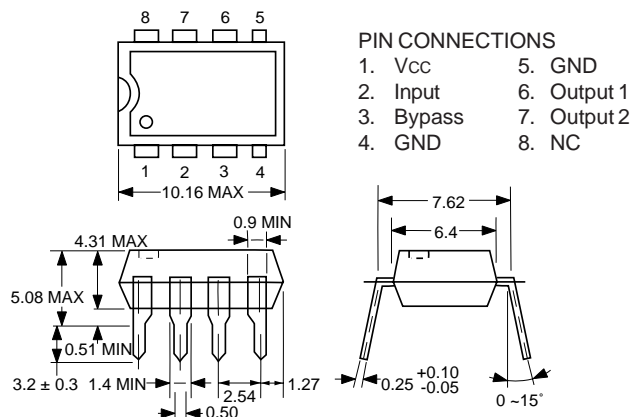

- PIN CONNECTIONS
- 1. Vcc
 - 2. Input
 - 3. Bypass
 - 4. GND
 - 5. GND
 - 6. Output 1
 - 7. Output 2
 - 8. NC

EXCLUSIVE AGENT FOR NEC Corporation RF & MICROWAVE SEMICONDUCTOR PRODUCTS - U.S. & CANADA

CALIFORNIA EASTERN LABORATORIES, INC • Headquarters • 4590 Patrick Henry Drive • Santa Clara, CA 95054-1817 • (408) 988-3500 • Telex 34-6393/FAX (408) 988-0279
DATA SUBJECT TO CHANGE WITHOUT NOTICE