

**8MHz, Precision, JFET Input Operational Amplifier**

The Intersil HA-5170 is a precision, JFET input, operational amplifier which features low noise, low offset voltage and low offset voltage drift. Constructed using FET/Bipolar technology, the Intersil Dielectric Isolation (DI) process, and laser trimming this amplifier offers low input bias and offset currents. This operational amplifier design also completely eliminates the troublesome errors due to warm-up drift.

Complementing these excellent input characteristics are dynamic performance characteristics never before available from precision operational amplifiers. An 8V/μs slew rate and 8MHz bandwidth allow the designer to extend precision instrumentation applications in both speed and bandwidth. These characteristics make the HA-5170 well suited for precision integrator amplifier designs.

The superior input characteristics also make the HA-5170 ideally suited for transducer signal amplifiers, precision voltage followers and precision data acquisition systems. For application assistance, please refer to Application Note AN540 addressing specifically this device.

Military version (-8) product and data sheets available upon request.

**Pinouts**

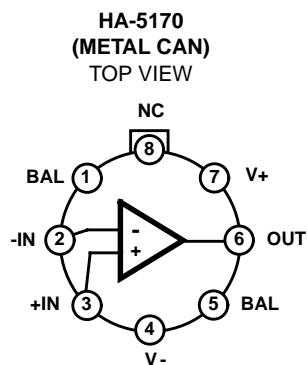
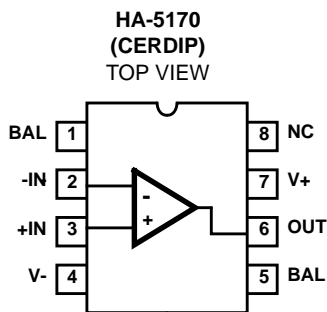

**Features**

- Low Offset Voltage . . . . . 100μV
- Low Offset Voltage Drift . . . . . 2μV/°C
- Low Noise . . . . . 10nV/√Hz
- High Open Loop Gain. . . . . 600kV/V
- Wide Bandwidth . . . . . 8MHz
- Unity Gain Stable

**Applications**

- High Gain Instrumentation Amplifiers
- Precision Data Acquisition
- Precision Integrators
- Precision Threshold Detectors
- For Further Design Ideas, Refer to Application Note 540

**Ordering Information**

PART NUMBER	TEMP. RANGE (°C)	PACKAGE	PKG. NO.
HA2-5170-5	0 to 75	8 Pin Metal Can	T8.C
HA7-5170-5	0 to 75	8 Ld CERDIP	F8.3A

# HA-5170

## Absolute Maximum Ratings

Voltage Between V+ and V- Terminals	44V
Differential Input Voltage	30V
Output Short Circuit Duration	Indefinite

## Operating Conditions

Temperature Range	
HA-5170-5	0°C to 75°C

CAUTION: Stresses above those listed in "Absolute Maximum Ratings" may cause permanent damage to the device. This is a stress only rating and operation of the device at these or any other conditions above those indicated in the operational sections of this specification is not implied.

## NOTE:

1.  $\theta_{JA}$  is measured with the component mounted on an evaluation PC board in free air.

## Thermal Information

Thermal Resistance (Typical, Note 1)	$\theta_{JA}$ (°C/W)	$\theta_{JC}$ (°C/W)
CERDIP Package	135	50
Metal Can Package	155	67
Maximum Junction Temperature	175°C	
Maximum Storage Temperature Range	-65°C to 150°C	
Maximum Lead Temperature (Soldering 10s)	300°C	

## Electrical Specifications $V_{SUPPLY} = \pm 15V$ , Unless Otherwise Specified

PARAMETER	TEST CONDITIONS	TEMP. (°C)	HA-5170-5			UNITS
			MIN	TYP	MAX	
<b>INPUT CHARACTERISTICS</b>						
Offset Voltage		25	-	0.1	0.3	mV
		Full	-	-	0.5	mV
Average Offset Voltage Drift (Note 3)		Full	-	2	5	$\mu V/^\circ C$
Bias Current		25	-	20	100	pA
		Full	-	0.1	2	nA
Bias Current Average Drift		Full	-	3	-	$pA/^\circ C$
Offset Current		25	-	3	60	pA
		Full	-	-	0.1	nA
Offset Current Average Drift (Note 3)		Full	-	0.3	1	$pA/^\circ C$
Common Mode Range		Full	$\pm 10$	+15.1	-	V
		Full	-	-12	-	V
Differential Input Capacitance		25	-	80	100	pF
Differential Input Resistance (Note 3)		25	$1 \times 10^{10}$	$6 \times 10^{10}$	-	$\Omega$
Input Capacitance (Single Ended)		25	-	12	-	pF
Input Noise Voltage (Note 3)	0.1Hz to 10Hz	25	-	0.5	5	$\mu V_{P-P}$
Input Noise Voltage Density (Note 3)	f = 10Hz	25	-	20	150	$nV/\sqrt{Hz}$
	f = 100Hz	25	-	12	50	$nV/\sqrt{Hz}$
	f = 1000Hz	25	-	10	25	$nV/\sqrt{Hz}$
Input Noise Current Density (Note 3)	f = 10Hz	25	-	0.05	-	$pA/\sqrt{Hz}$
	f = 100Hz	25	-	0.01	-	$pA/\sqrt{Hz}$
	f = 1000Hz	25	-	0.01	0.1	$pA/\sqrt{Hz}$
<b>TRANSFER CHARACTERISTICS</b>						
Large Signal Voltage Gain	$V_{OUT} = \pm 10V$ , $R_L = 2k\Omega$	25	300	600	-	kV/V
		Full	250	-	-	kV/V
Common Mode Rejection Ratio	$\Delta V_{CM} = \pm 10V$	Full	90	100	-	dB

# HA-5170

## Electrical Specifications $V_{SUPPLY} = \pm 15V$ , Unless Otherwise Specified (Continued)

PARAMETER	TEST CONDITIONS	TEMP. (°C)	HA-5170-5			UNITS
			MIN	TYP	MAX	
Minimum Stable Gain		25	1	-	-	V/V
Closed Loop Bandwidth	$A_{VCL} = +1$	25	4	8	-	MHz
<b>OUTPUT CHARACTERISTICS</b>						
Output Voltage Swing	$R_L = 2k\Omega$	25	$\pm 10$	$\pm 12$	-	V
Full Power Bandwidth (Note 4)	$R_L = 2k\Omega$	25	80	120	-	kHz
Output Current (Note 5)	$V_{OUT} = \pm 10V$	25	$\pm 10$	$\pm 15$	-	mA
Output Resistance (Note 3)	Open Loop, 100Hz	25	-	45	100	$\Omega$
<b>TRANSIENT RESPONSE</b>						
Rise Time	Note 2	25	-	45	100	ns
Slew Rate	Note 2	25	5	8	-	V/ $\mu$ s
Settling Time (Notes 3, 7)		25	-	1	5	$\mu$ s
<b>POWER SUPPLY CHARACTERISTICS</b>						
Supply Current		Full	-	1.9	2.5	mA
Power Supply Rejection Ratio (Note 8)		Full	90	105	-	dB

### NOTES:

- See "Test Circuits and Waveforms" section.
- Parameter is not 100% tested. 90% of all units meet or exceed these specifications.
- Full power bandwidth guaranteed based on slew rate measurement using:  $FPBW = \frac{\text{Slew Rate}}{2\pi V_{PEAK}}$ .
- $I_{SC}$  turns on at  $\approx 23mA$ .
- Settling time is measured to 0.1% of final value for a 10V output step and  $A_V = -1$ .
- $V_+ = +15V$ ,  $V_- = -10V$  to  $-20V$  and  $V_- = -15V$ ,  $V_+ = +10V$  to  $+20V$ .

## Test Circuits and Waveforms

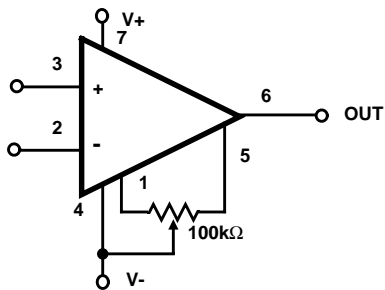

Tested Offset Adjustment Range is  $|V_{OS} + 1mV|$  minimum referred to output. Typical range is  $\pm 5mV$  with  $R_T = 1k\Omega$  and  $\pm 15mV$  with  $R_T = 100k\Omega$ .

FIGURE 1.  $V_{OS}$  ADJUSTMENT

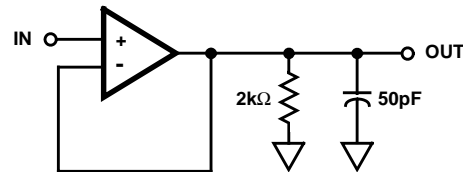
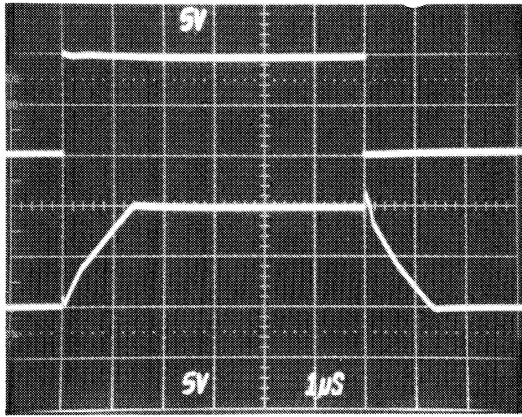

FIGURE 2. LARGE AND SMALL SIGNAL RESPONSE CIRCUIT

Test Circuits and Waveforms (Continued)



Vertical Scale: 5V/Div.  
Horizontal Scale: 1µs/Div.

**LARGE SIGNAL RESPONSE**

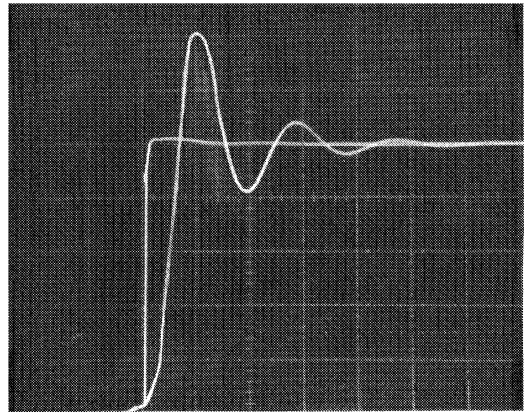

Vertical Scale: 10mV/Div.  
Horizontal Scale: 100ns/Div.

**SMALL SIGNAL RESPONSE**

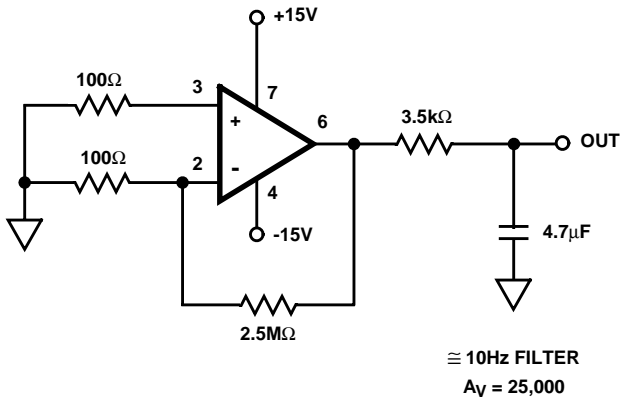

**FIGURE 3. LOW FREQUENCY NOISE TEST CIRCUIT**

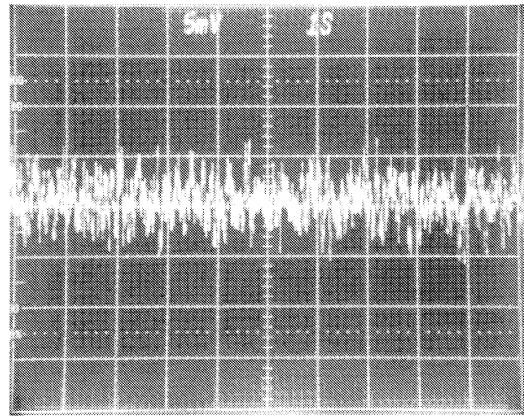

Vertical Scale: 200nV/Div. (Noise Referred to Input)  
5mV/Div. at Output,  $A_{VCL} = 25,000$   
Horizontal Scale: 1s/Div.

**HA-5170 LOW FREQUENCY NOISE (0.1Hz TO 10Hz)**

Schematic Diagram

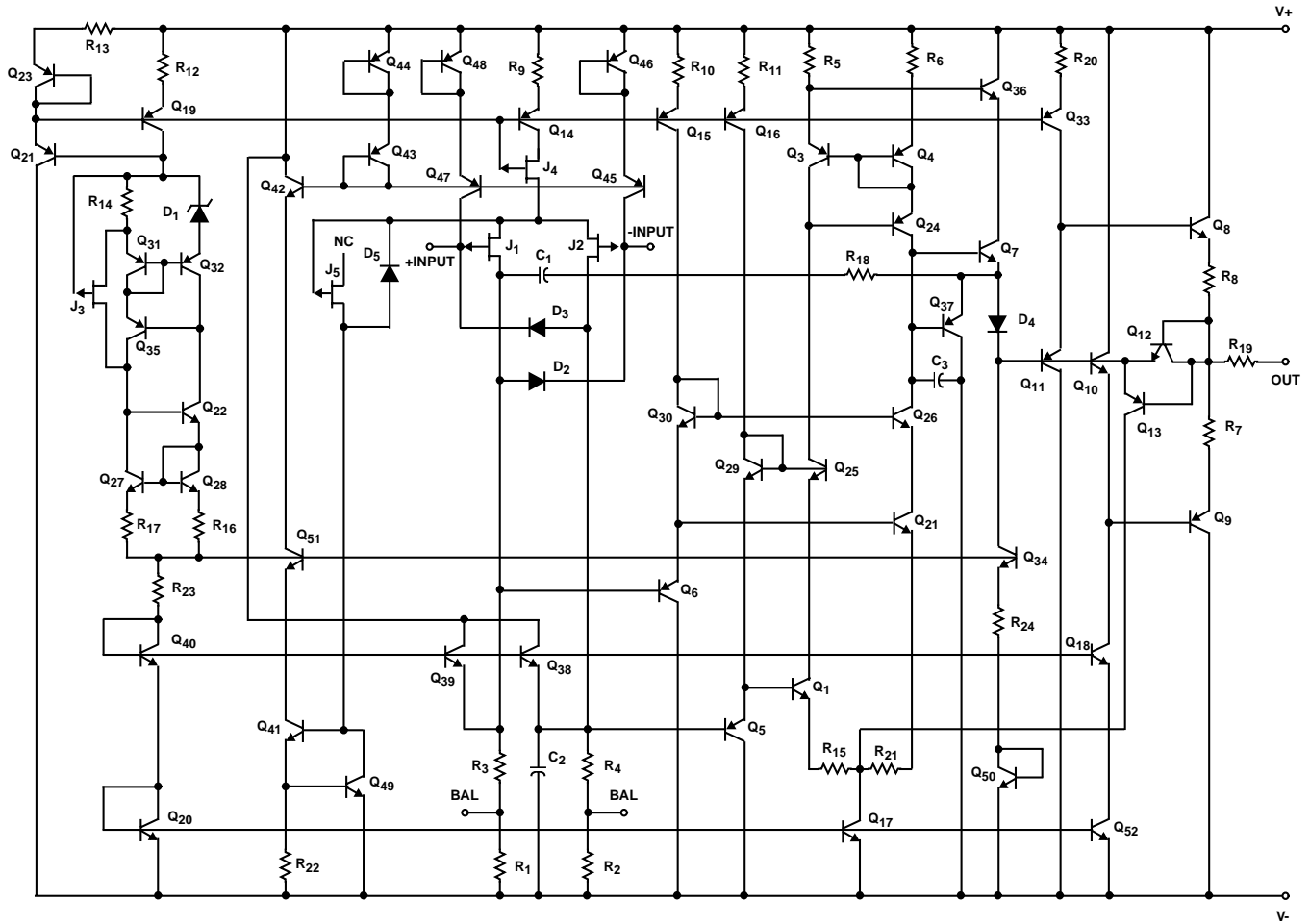

5 intersil

HA-5170

Typical Performance Curves

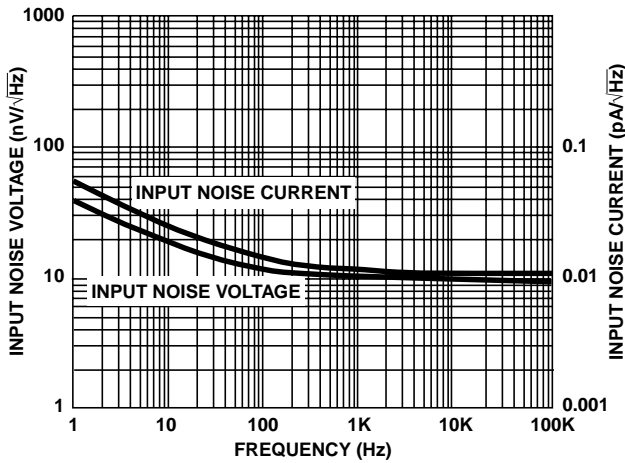

FIGURE 4. INPUT NOISE vs FREQUENCY

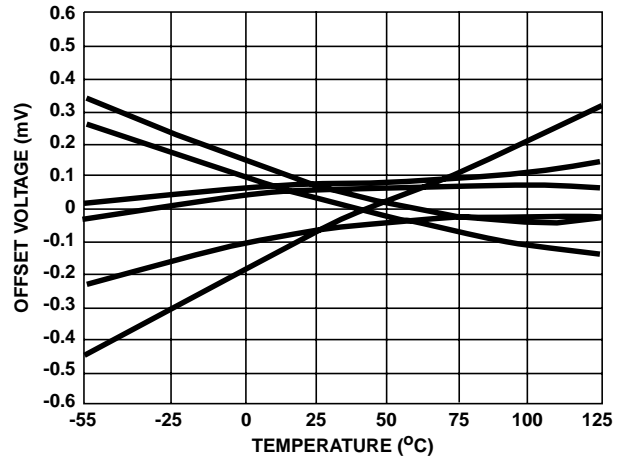

FIGURE 5. OFFSET VOLTAGE DRIFT vs TEMPERATURE OF REPRESENTATIVE UNITS

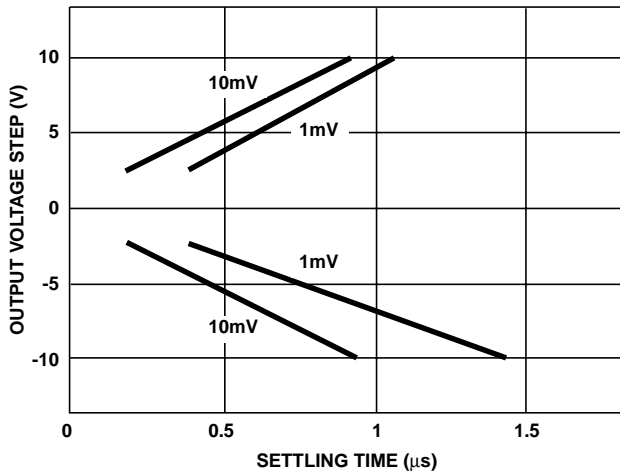

FIGURE 6. SETTLING TIME FOR VARIOUS OUTPUT STEP VOLTAGES

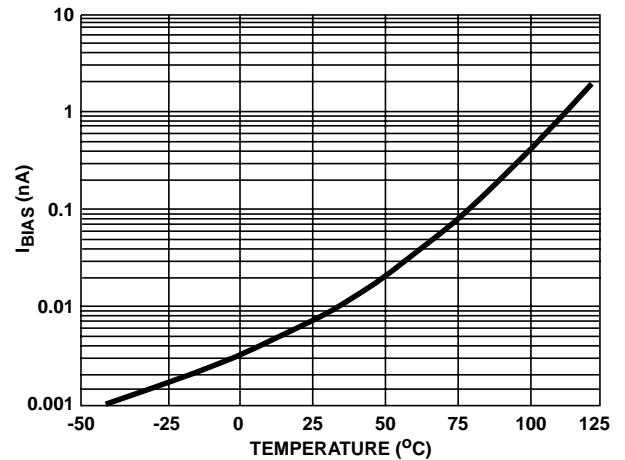

FIGURE 7. BIAS CURRENT vs TEMPERATURE

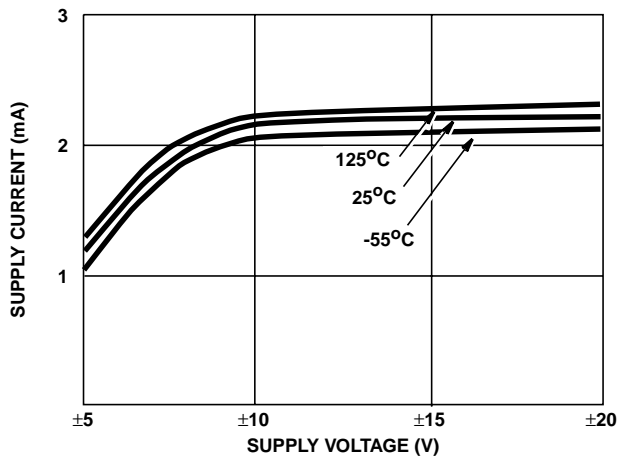

FIGURE 8. POWER SUPPLY CURRENT vs SUPPLY VOLTAGE

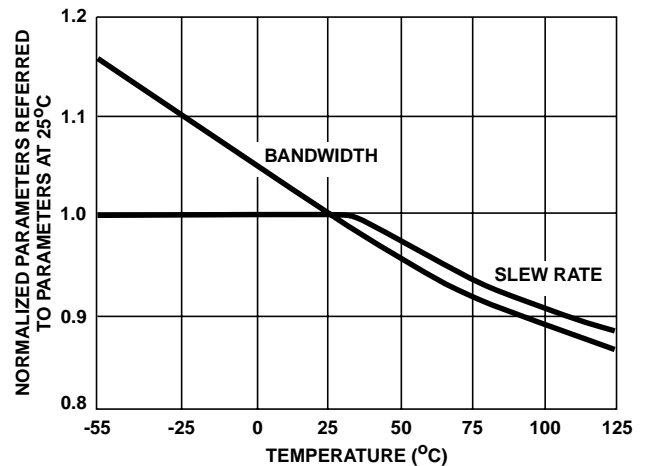

FIGURE 9. NORMALIZED AC PARAMETERS vs TEMPERATURE

Typical Performance Curves (Continued)

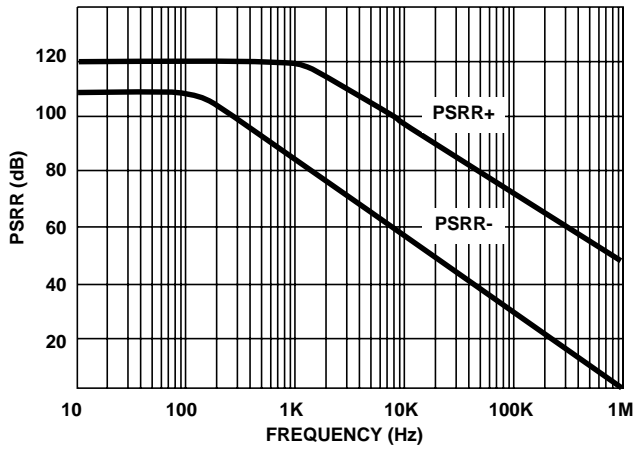

FIGURE 10. POWER SUPPLY REJECTION RATIO vs FREQUENCY

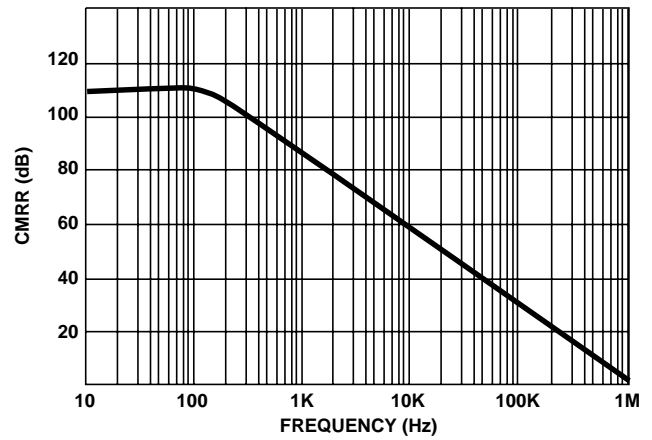

FIGURE 11. COMMON MODE REJECTION RATIO vs FREQUENCY

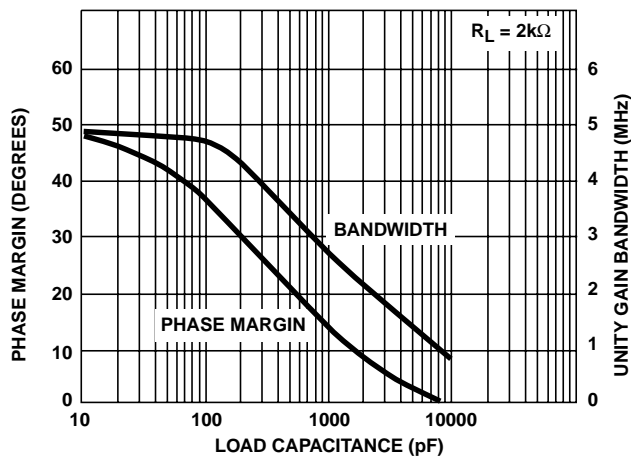

FIGURE 12. SMALL SIGNAL BANDWIDTH AND PHASE MARGIN vs LOAD CAPACITANCE

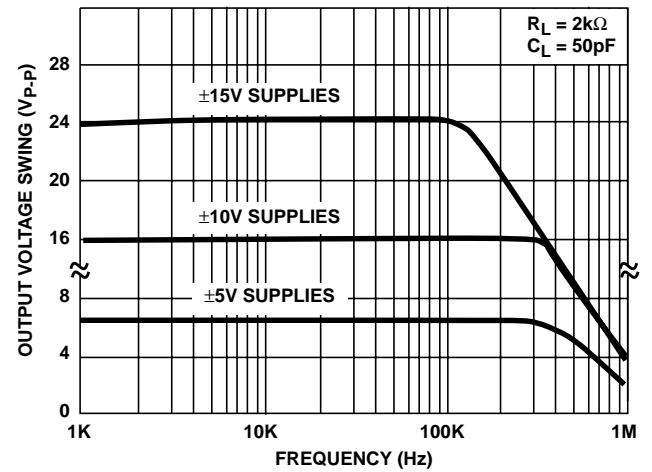

FIGURE 13. OUTPUT VOLTAGE SWING vs FREQUENCY AND SUPPLY VOLTAGE

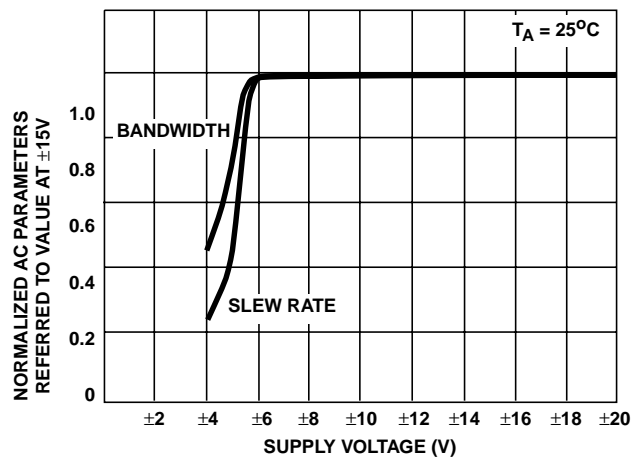

FIGURE 14. NORMALIZED AC PARAMETERS vs SUPPLY VOLTAGE

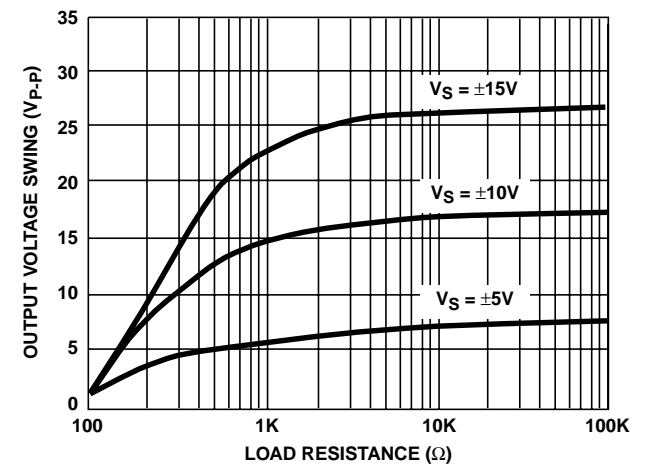

FIGURE 15. MAXIMUM OUTPUT VOLTAGE SWING vs LOAD RESISTANCE

## Typical Performance Curves (Continued)

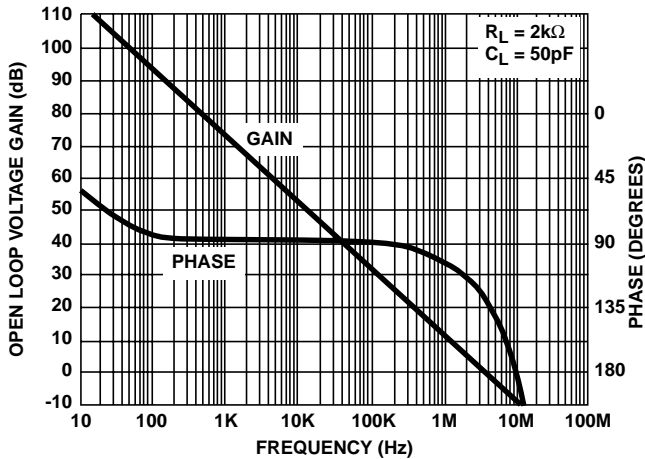

FIGURE 16. OPEN LOOP FREQUENCY RESPONSE

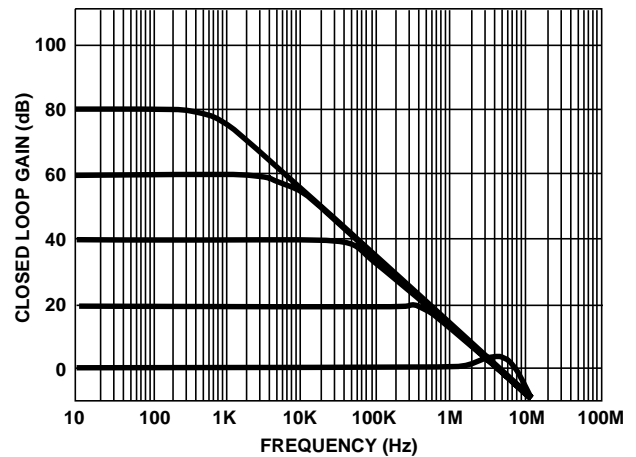

FIGURE 17. CLOSED LOOP FREQUENCY RESPONSE FOR VARIOUS CLOSED LOOP GAINS

All Intersil semiconductor products are manufactured, assembled and tested under **ISO9000** quality systems certification.

*Intersil semiconductor products are sold by description only. Intersil Corporation reserves the right to make changes in circuit design and/or specifications at any time without notice. Accordingly, the reader is cautioned to verify that data sheets are current before placing orders. Information furnished by Intersil is believed to be accurate and reliable. However, no responsibility is assumed by Intersil or its subsidiaries for its use; nor for any infringements of patents or other rights of third parties which may result from its use. No license is granted by implication or otherwise under any patent or patent rights of Intersil or its subsidiaries.*

For information regarding Intersil Corporation and its products, see web site [www.intersil.com](http://www.intersil.com)

### Sales Office Headquarters

#### NORTH AMERICA

Intersil Corporation  
P. O. Box 883, Mail Stop 53-204  
Melbourne, FL 32902  
TEL: (321) 724-7000  
FAX: (321) 724-7240

#### EUROPE

Intersil SA  
Mercure Center  
100, Rue de la Fusee  
1130 Brussels, Belgium  
TEL: (32) 2.724.2111  
FAX: (32) 2.724.22.05

#### ASIA

Intersil (Taiwan) Ltd.  
7F-6, No. 101 Fu Hsing North Road  
Taipei, Taiwan  
Republic of China  
TEL: (886) 2 2716 9310  
FAX: (886) 2 2715 3029