

Two Panel Electroluminescent Lamp Driver

- Single IC Drives 2 EL Lamps
For Backlighting:
 - Cell Phone Keypad & LCD
 - Multi-Color EL Lamps
 - Multi-Segment EL Lamps
- Control Over Lamp-A & Lamp-B For Independent Or Concurrent Operation
- +2.2V to +6.0V Battery Operation
- Single Coil Used To Generate High Voltage AC Outputs
- Low Power Standby Mode Draws 100nA Typical Current
- A Single Resistor Controls the Internal Oscillator
- DC-AC Inverter Produces Up To 220V_{PP}
- Space-Saving 10MSOP Package

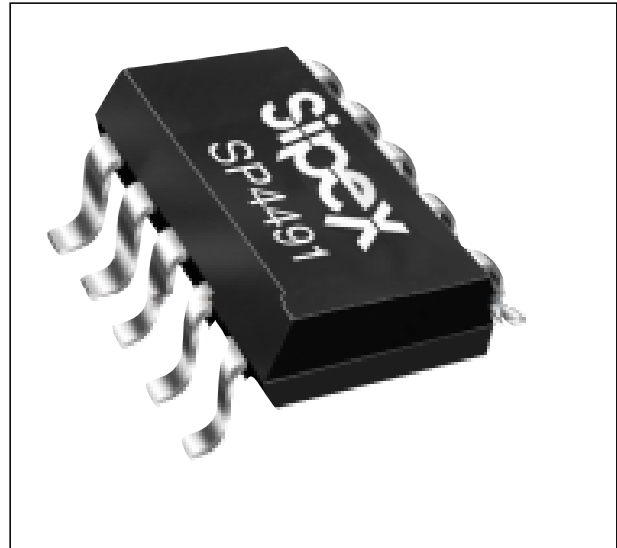

APPLICATIONS

- Cellular Phones
- PDA's
- Handheld GPS Units
- Security Systems
- POS Terminals

DESCRIPTION

The SP4491 electroluminescent lamp driver provides designers of cell phones PDA's and other handheld, portable electronic devices with an integrated solution for driving two EL lamps independently or concurrently. The SP4491 reduces system cost, component count and board space requirements over a discrete 2-EL driver approach. The EL lamps operate in opposite phase so the SP4491 can be easily implemented in applications driving multi-color or multi-segment EL lamps. The SP4491 operates from a +2.2V to +6.0V battery source. The device features a low power standby mode which draws less than 1 μ A. The frequency of the internal oscillator is set using a single external resistor. A single external inductor is required to generate the high voltage AC outputs to drive the EL lamps. All input pins are ESD protected with internal diodes to V_{DD} and V_{SS}.

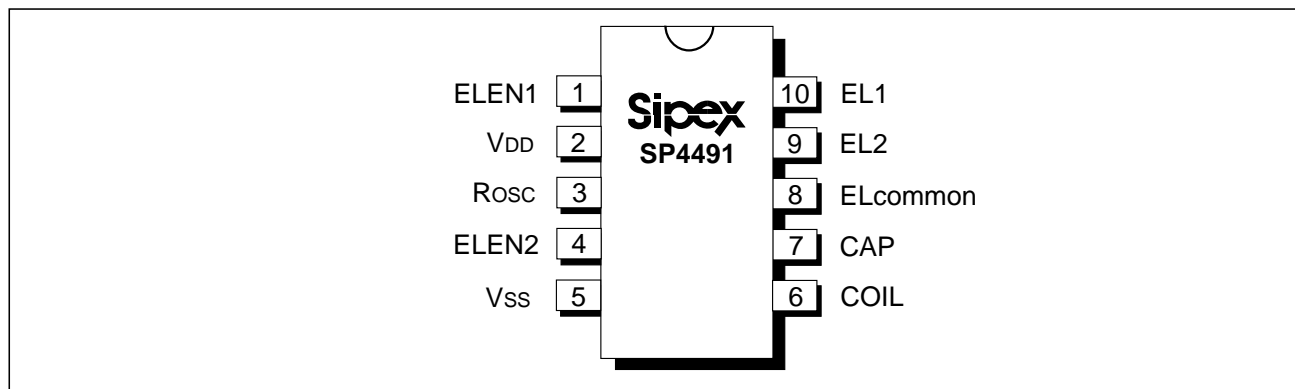

ABSOLUTE MAXIMUM RATINGS

These are stress ratings only and functional operation of the device at these ratings or any other above those indicated in the operation sections of the specifications below is not implied. Exposure to absolute maximum rating conditions for extended periods of time may affect reliability.

Power Supply, V_{DD}7.0V
 Input Voltages, Logic.....-0.3V to ($V_{DD}+0.3V$)
 Lamp Outputs.....220V_{P-P}
 Operating Temperature.....-40°C to +85°C
 Storage Temperature.....-65°C to +150°C

Power Dissipation Per Package
 10-pin MSOP
 (derate 8.84mW/°C above +70°C).....720mW

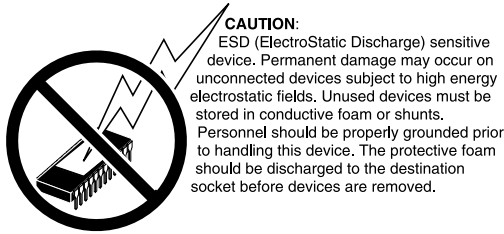

STORAGE CONSIDERATIONS

Storage in a low humidity environment is preferred. Large high density plastic packages are moisture sensitive and should be stored in Dry Vapor Barrier Bags. Prior to usage, the parts should remain bagged and stored below 40°C and 60%RH. If the parts are removed from the bag, they should be used within 48 hours or stored in an environment at or below 20%RH. If the above conditions cannot be followed, the parts should be baked for four hours at 125°C in order remove moisture prior to soldering. Sipex ships product in Dry Vapor Barrier Bags with a humidity indicator card and desiccant pack. The humidity indicator should be below 30%RH.

The information furnished by Sipex has been carefully reviewed for accuracy and reliability. Its application or use, however, is solely the responsibility of the user. No responsibility for the use of this information become part of the terms and conditions of any subsequent sales agreement with Sipex. Specifications are subject to change without no responsibility for any infringement of patents or other rights of third parties which may result from its use. No license or other proprietary rights are granted by implication or otherwise under any patent or patent rights of Sipex Corporation.

SPECIFICATIONS

$V_{DD} = +3.0V$, $L_{COIL} = 2.2mH$, $R_{OSC} = 560k\Omega$, EI Lamp Load = 4.7nF; CINT = 1000pF and $T_{AMB} = 25^\circ C$ unless otherwise noted.

PARAMETER	MIN.	TYP.	MAX.	UNITS	CONDITIONS
Supply Voltage, V_{DD}	2.2		6	V	
Supply Current, I_{DD}		10	54	mA	
Coil Voltage, V_{COIL}	V_{DD}		9	V	
ELEN1/ELEN2 Input Voltage, V_{ELEN} LOW HIGH	-0.25 $V_{DD}-0.25$	0 V_{DD}	0.25V $V_{DD}+0.25$	V	
Shutdown Current, $I_{SD}=I_{COIL}+I_{DD}$.1	1	μA	$V_{ELEN}=0V$
INDUCTOR DRIVE					
Coil Frequency, f_{COIL}	36.0 32.0	44.0	55.7 58.2	kHz	$T_{AMB}=+25^\circ C$ $T_{AMB}=-40^\circ C$ to $+85^\circ C$
Coil Duty Cycle		90		%	$T_{AMB}=+25^\circ C$
Coil Current, I_{COIL}		9	45	mA	
Peak Coil Current, $I_{PK-COIL}$		20	90	mA	
EL LAMP OUTPUT					
EL Lamp Frequency, f_{LAMP}	281 250	343	435 455	Hz	$T_{AMB}=+25^\circ C$, $V_{DD}=+3.0V$ $T_{AMB}=-40^\circ C$ to $+85^\circ C$
Peak to Peak Output Voltage, V_{PK-PK}	140		202	V	$T_{AMB}=+25^\circ C$

PINOUT

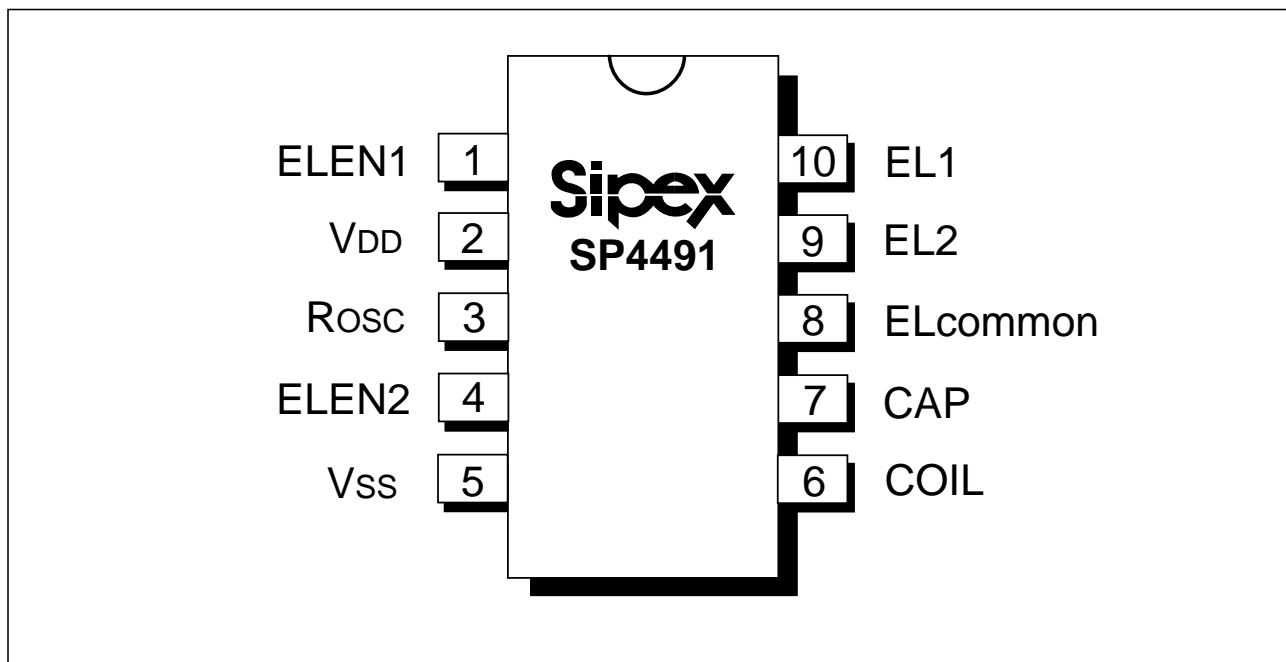

PIN ASSIGNMENTS

Pin 1 — ELEN1 — Electroluminescent Lamp Enable Control Line 1. This is a control line to enable a single or dual EL lamp output. Refer to Table 1 for the control logic.

Pin 2 — V_{DD} — Positive Battery Power Supply. Connect such that $+2.636V < V_{DD} < +3.15V$.

Pin 3 — R_{OSC} — Oscillator Resistor. Connecting a resistor between this input pin and V_{DD} sets the frequency of the internal clock.

Pin 4 — ELEN2 — Electroluminescent Lamp Enable Control Line 2. This a control line to enable a single or dual EL lamp output. Refer to Table 1 for the control logic.

Pin 5 — V_{SS} — Power Supply Common. Connect to the lowest circuit potential, typically ground.

Pin 6 — COIL — Coil. The inductor for the boost converter is connected from V_{BATT} to this input pin.

Pin 7 — CAP — Integrator Capacitor. An integrating capacitor (1800pF typically) connected from this pin to ground filters out any coil switching spikes or ripple present in the output waveform to the EL lamps. Connecting a fast recovery diode from COIL to CAP increases the light output of the EL lamp.

Pin 8 — EL COMMON — Electroluminescent Common. This is a high voltage lamp driver output pin common to both EL lamps.

Pin 9 — EL2 — Electroluminescent Lamp Output 2. This is a high voltage lamp driver output pin connect to the second EL lamp.

Pin 10 — EL1 — Electroluminescent Lamp Output 1. This is a high voltage lamp driver output pin to connect to the first EL lamp.

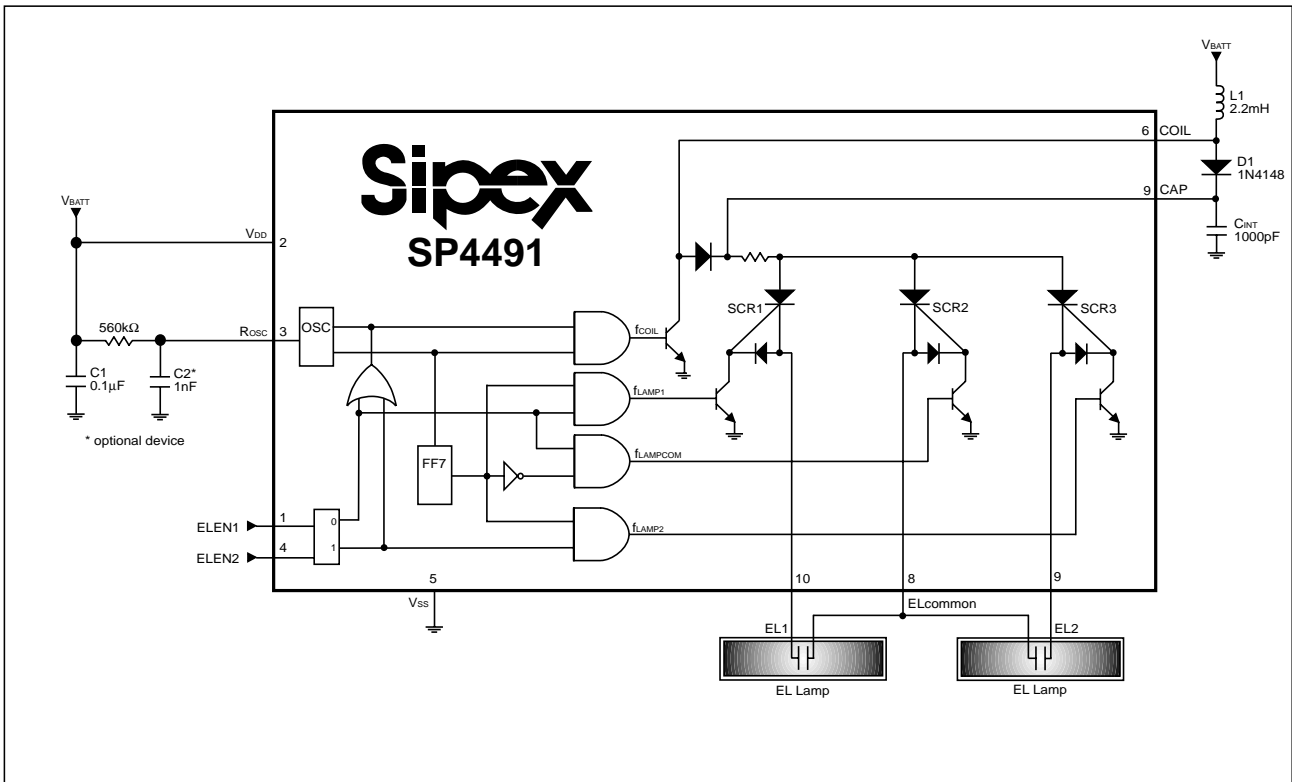

Figure 1: Internal Block Diagram of SP4491

ELEN1	ELEN2	EL1 Output	EL2 Output
0	0	OFF	OFF
0	1	OFF	ON
1	0	ON	OFF
1	1	ON	ON

Table 1: Control Line Logic Table

DESCRIPTION

The SP4491 electroluminescent lamp driver provides designers of cell phones, PDA's and other handheld, portable electronic devices with an integrated solution for driving two EL lamps independently or simultaneously. The SP4491 reduces system cost, component count and board space requirements over a discrete 2 EL driver approach. The EL lamps operate in opposite phase so the SP4491 can be easily implemented in applications driving multi-color or multi-segment EL lamps. The SP4491 operates from a +2.2V to +6.0V battery source. The device features a low power standby mode that draws less than 1 μ A. The frequency of the internal oscillator is set using a single external resistor. A single external inductor is required to generate the high voltage AC outputs to drive the EL lamps. All input pins are ESD protected with internal diodes to V_{DD} and V_{SS} .

The SP4491 contains a DC-AC inverter that can produce an AC output of 180V_{PP} (typical) from a 3.0V input voltage. An internal block diagram of the SP4491 can be found in Figure 1.

Electroluminescent Technology

An EL lamp consists of a thin layer of phosphorous material sandwiched between two strips of plastic which emits light (fluoresces) when a high voltage AC signal is applied across it. It behaves primarily as a capacitive load. Long periods of DC voltage applied to the material tend to reduce its lifetime. With these conditions in mind, the ideal signal to drive an EL lamp is a high voltage sine wave. Traditional approaches to achieve this type of waveform include discrete circuits incorporating a transformer, transistors and several resistors and capacitors.

This approach is large and bulky and cannot be implemented in most handheld equipment. Sipex offers low power single chip driver circuits specifically designed to drive small to medium sized electroluminescent panels. Sipex EL drivers provide a differential AC voltage without a DC offset to maximize EL lamp lifetime. The only additional components required for the EL driver circuitry are an inductor, resistor and capacitor.

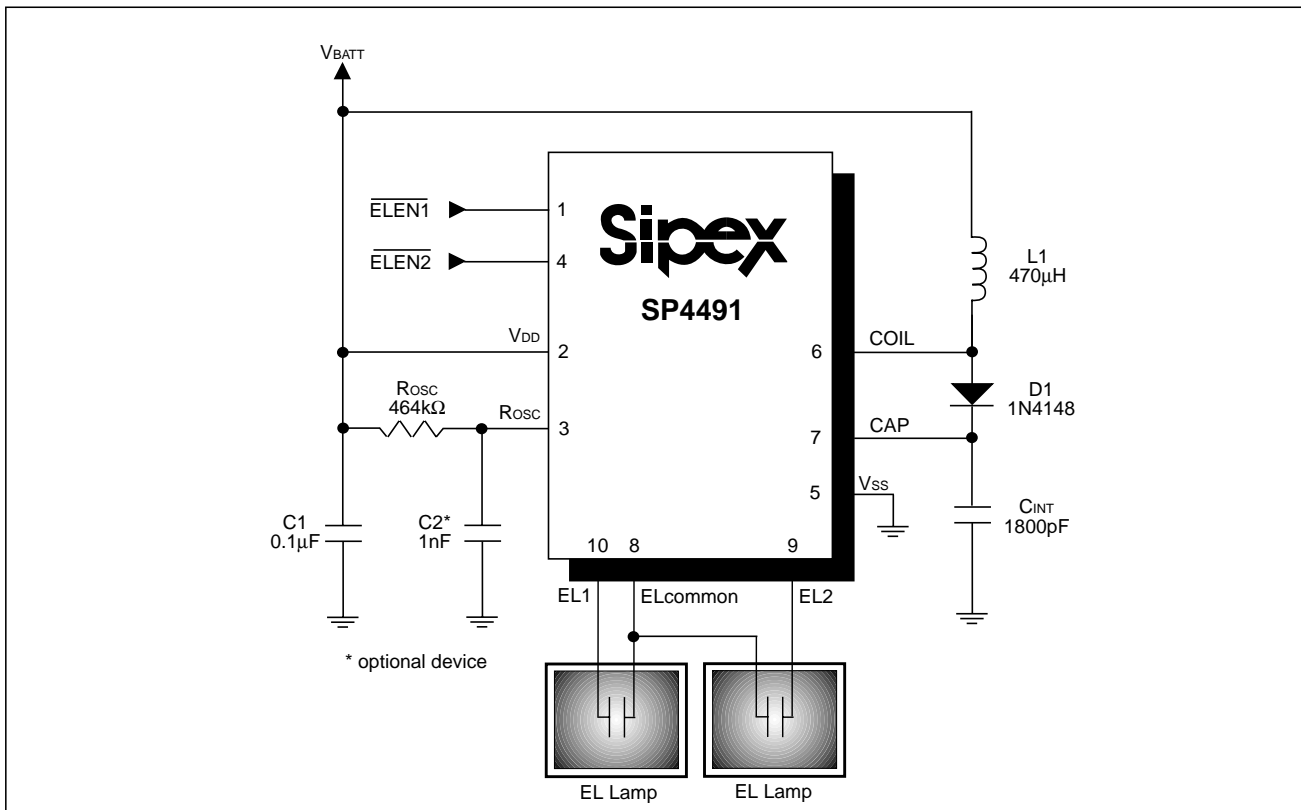

Figure 2: Typical Application Circuit of SP4491

Electroluminescent backlighting is ideal when used with LCD displays, keypads or other backlit readouts. EL lamps uniformly light an area without creating any undesirable "hot spots" in the display. Also, an EL lamp typically consumes less power than LED's or incandescent bulbs in similar lighting situations. These features make EL ideal for attractive, battery powered products.

THEORY OF OPERATION

Coil Switch

The SP4491 has an inductor-based boost converter to generate the high voltage used to drive the EL lamp. Energy is stored in the inductor according to the equation $E_L = 1/2 (LI_{pk}^2)$ where $I_{pk} = (t_{ON})(V_{BATT} - V_{CESAT})/L$. An internal oscillator controls the coil switch. During the time the coil switch is on, the coil is connected between V_{DD} and the saturation voltage of the coil switch.

While the coil is connected between V_{DD} and coil switch and a magnetic field develops in the coil. When the coil switch turns off, the switch opens, the magnetic field collapses and the voltage across the coil rises. The internal diode forward biases when the coil voltage rises above the H-Bridge voltage and the energy enters the EL lamp. Each pulse increases the voltage across the lamp in discrete steps.

As the voltage approaches its maximum, the steps become smaller. (see figure 4).

The brightness of the EL lamp output is directly related to energy recovery in the boost converter. There are many variations among coils such as magnetic core differences, winding differences and parasitic capacitances. For suggested coil suppliers refer to page 10.

Oscillator

The internal oscillator generates a high frequency clock used by the boost converter and H-Bridge. And

An external resistor from VDD to ROSC sets the oscillator frequency. Typically a 560kΩ resistor sets the frequency to 44.0kHz. The high frequency clock directly controls the coil switch. This high frequency clock is divided by 128 to generate a low frequency clock which controls the EL H-Bridge and sets the EL lamp frequency. The oscillator has low sensitivity to temperature and supply voltage variations, increasing the performance of the EL driver over the operating parameters.

Dual H-Bridge

The H-Bridge consists of two SCR structures and two NPN transistors that control how the lamp is charged. Setting ON/OFF to HIGH activates the H-Bridge that is selected by EL1/EL2. If the EL1/EL2 is low, EL1 is illuminated. If EL1/EL2 is HIGH, EL2 is illuminated. The EL driver illuminates the lamp by applying the high voltage supply of the boost converter to the lamp terminals through the H-Bridge and then switching the terminal polarity between the high voltage supply and ground at a constant frequency. This applies an AC voltage to the lamp that is twice the peak output voltage of the boost driver. An AC voltage greater than the 40V across the terminals of the lamp is typically necessary to adequately illuminate the EL lamp. Setting ON/OFF to LOW disables the outputs and places the circuit in a low power state.

DESIGN CONSIDERATIONS

Inductor Selection

If limiting peak current draw from the power supply is important, small coil values (<1mH) may need a higher oscillator frequency. Inductor current ramps faster in a lower inductance coil than a higher inductance coil for a given coil switch on time period, resulting in higher peak coil currents.

It is important to observe the saturation current rating of a coil. When this current is exceeded, the coil is incapable of storing any more energy and then ceases to act as an inductor. Instead, the coil behaves according to its series DC resistance.

Since small coils (<1mH) have inherently low series DC resistance, the current can peak dramatically through a small coil during saturation. This situation results in wasted energy not stored in the magnetics of the coil but expressed as heating which could lead to failure of the coil.

Generally, selecting a coil with lower series DC resistance will result in a system with higher efficiency and lamp brightness.

Lamp Effects

EL lamp parameters vary between manufacturers. Series DC resistance, lighting efficiency and lamp capacitance per area differ the most overall. Larger lamps require more energy to illuminate. Lowering the oscillator frequency allows more energy to be stored in the coil during each coil switch cycle and increases lamp brightness. The oscillator frequency can be lowered to a point where the lamp brightness then begins to drop because the lamp frequency must be above a critical frequency (approx. 100Hz) to light. Lamp color is affected by the switching frequency of the EL driver. Green EL lamps will emit a more blue light as EL lamp frequency increases.

Noise Decoupling on Logic Inputs

If EL1/EL2 or ON/OFF are connected to traces susceptible to noise, it may be necessary to connect bypass capacitor of approximately 10nF between EL1/EL2 and VSS, and ON/OFF and VSS. If these inputs are driven by a microprocessor which provides a low impedance HIGH and LOW signal, then noise bypassing may not be necessary.

Increasing Light Output

EL lamp light output can be improved by connecting a fast recovery diode from the COIL pin to the CAP pin. The internal diode is bypassed resulting in an increase in light output at the EL lamp. We suggest a fast recovery diode such as the industry standard 1N4148.

The optimal value of C_{INT} will vary depending on the lamp parameters and coil value. Lower C_{INT} values can decrease average supply current but

higher C_{INT} values can increase lamp brightness. This is best determined by experimentation. A rule of thumb is larger coils (1mH) are paired with a smaller C_{INT} (680pF) and smaller coils (470 μ H) are paired with a larger C_{INT} (1800pF).

Changing the EL lamp Output Voltage Waveform

Designers can alter the sawtooth output voltage waveform to the EL lamp. Increasing the capacitance of the integration capacitor, C_{INT} , will integrate the sawtooth waveform making it appear more like a square wave.

Printed Circuit Board Layout Suggestions

The EL driver's high-frequency operation makes PCB layout important for minimizing electrical noise. Keep the IC's GND pin and the ground leads of C1 and C_{INT} less than 0.2in (5mm) apart. Also keep the connections to the COIL pin as short as possible. To maximize output power and efficiency and minimize output ripple voltage, use a ground plane and solder the IC's VSS pin directly to the ground plane.

EL Lamp Driver Design Challenges

There are many variables which can be optimized for specific applications. The amount of light emitted is a function of the voltage applied to the lamp, the frequency at which is applied, the lamp material, the lamp size, and the inductor used. Sipex supplies characterization charts to aid the designer in selecting the optimum circuit configuration.

Sipex will perform customer application evaluations, using the customer's actual EL lamp to determine the optimum operating conditions for specific applications. For customers considering an EL backlighting solution for the first time, Sipex is able to provide retrofits to non-backlit products for a thorough electrical and cosmetic evaluation. Please contact your local Sipex sales Representative or the Sipex factory directly to initiate this valuable service.

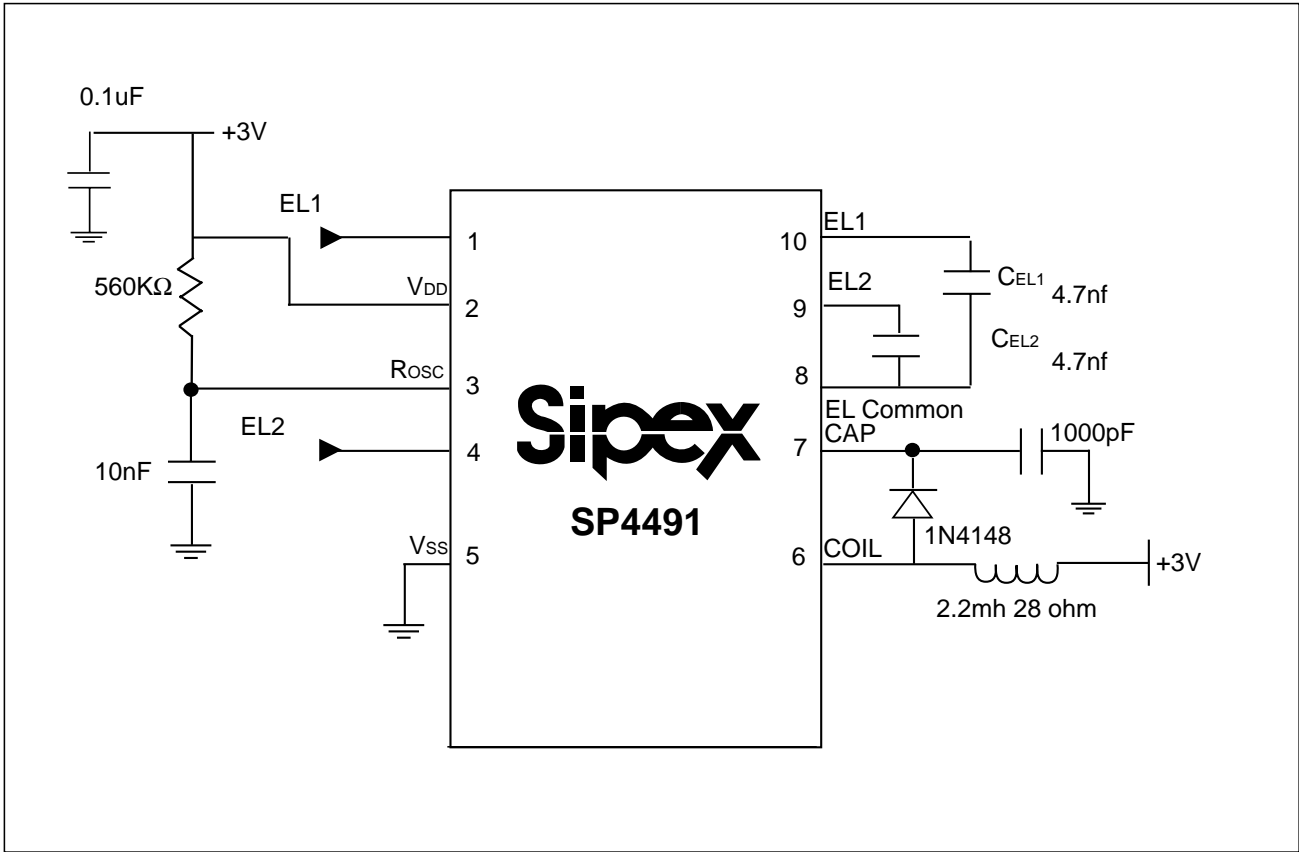

Figure 3: Test Circuit Diagram of SP4491

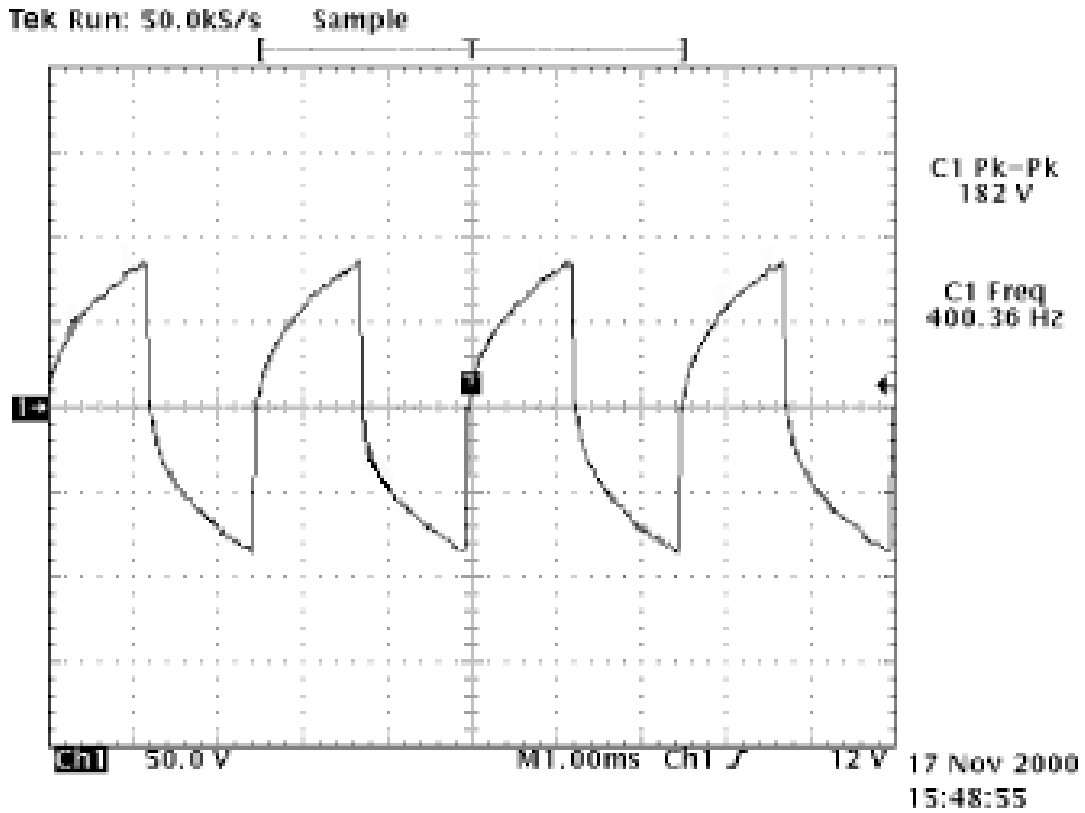

Figure 4: Typical EL Lamp Voltage Waveform

PERFORMANCE CHARACTERISTICS

Supply Current vs Rosc

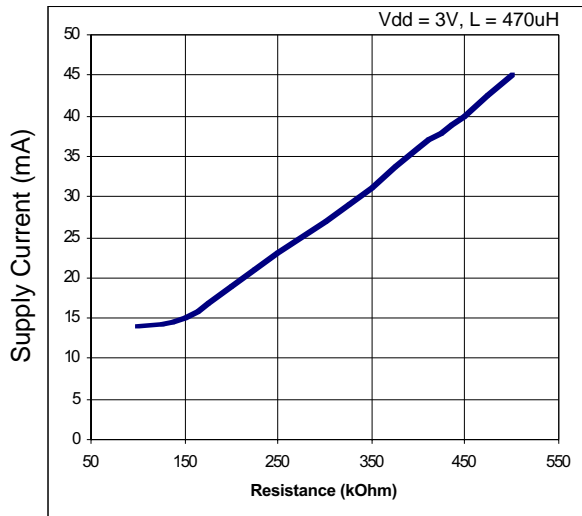

Figure 5

Luminance vs Rosc

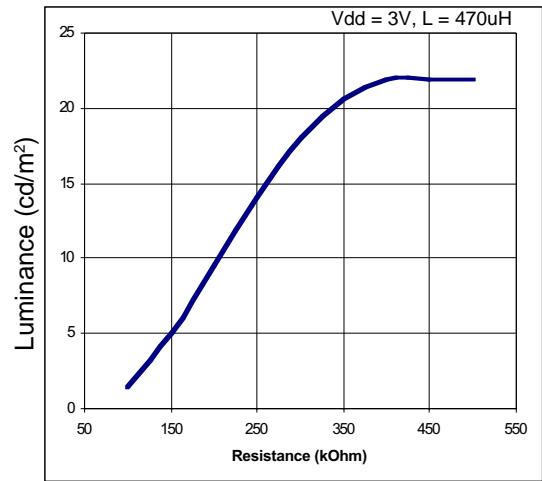

Figure 7

Lamp Frequency vs. Rosc

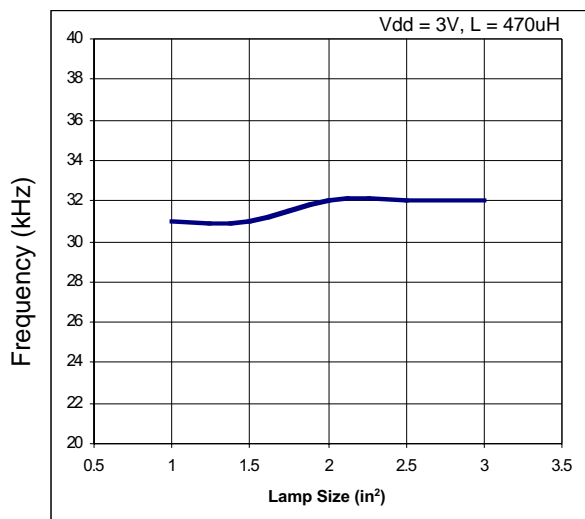

Figure 6

Output Voltage vs. Rosc

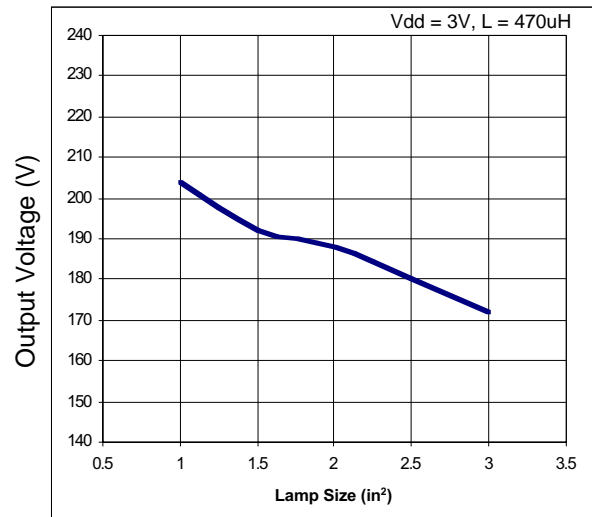

Figure 8

PERFORMANCE CHARACTERISTICS

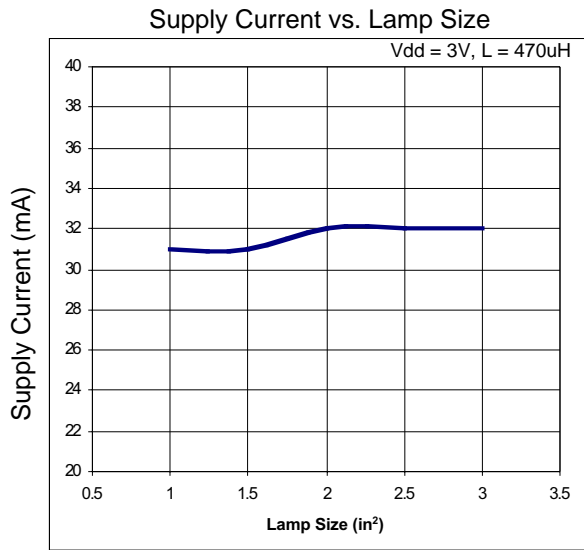

Figure 9

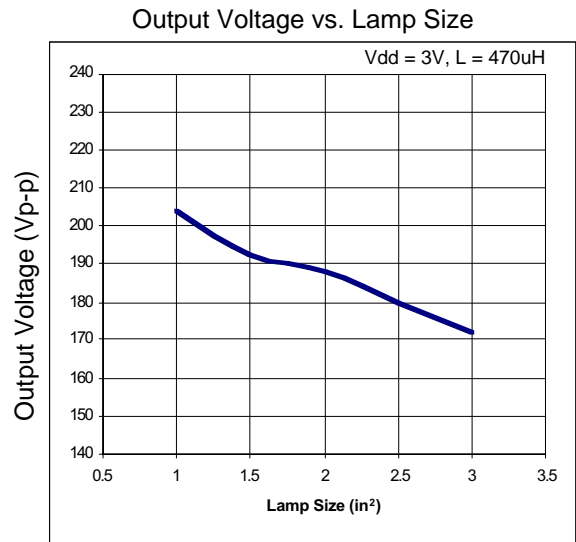

Figure 11

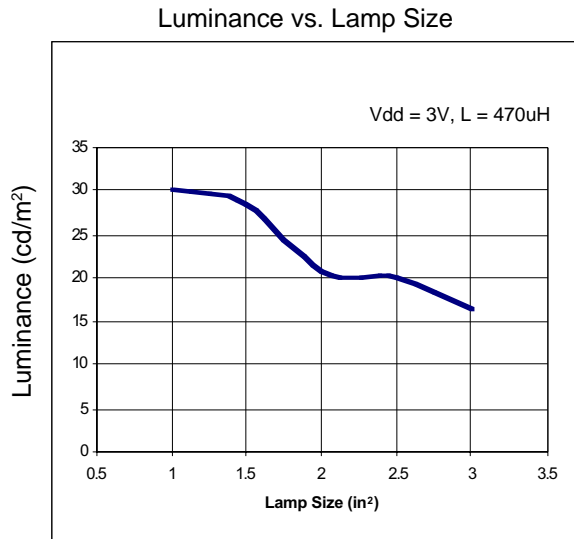

Figure 10

Coil Manufacturers

Hitachi Metals
Material Trading Division
2101 S. Arlington Heights Road,
Suite 116
Arlington Heights, IL 60005-4142
Phone: 1-800-777-8343 Ext. 12
(847) 364-7200 Ext. 12
Fax: (847) 364-7279

Hitachi Metals Ltd. Europe
Immernannstrasse 14-16, 40210
Dusseldorf, Germany
Contact: Gary Loos
Phone: 49-211-16009-0
Fax: 49-211-16009-29

Hitachi Metals Ltd.
Kishimoto Bldg. 2-1, Marunouchi
2-chome, Chiyoda-Ku, Tokyo, Japan
Contact: Mr. Noboru Abe
Phone: 3-3284-4936
Fax: 3-3287-1945

Hitachi Metals Ltd. Singapore
78 Shenton Way #12-01,
Singapore 079120
Contact: Mr. Stan Kaiko
Phone: 222-8077
Fax: 222-5232

Hitachi Metals Ltd. Hong Kong
Room 1107, 11/F., West Wing,
Tsim Sha. Tsui Center 66
Mody Road, Tsimshatsui East,
Kowloon, Hong Kong
Phone: 2724-4188
Fax: 2311-2095

Murata
2200 Lake Park Drive, Smyrna
Georgia 30080 U.S.A.
Phone: (770) 436-1300
Fax: (770) 436-3030

Murata European
Holbeinstrasse 21-23, 90441
Nurnberg, Postfachanschrift 90015
Phone: 011-4991166870
Fax: 011-49116687225

Murata Taiwan Electronics
225 Chung-Chin Road, Taichung,
Taiwan, R.O.C.
Phone: 011 88642914151
Fax: 011 88644252929

Murata Electronics Singapore
200 Yishun Ave. 7, Singapore
2776, Republic of Singapore
Phone: 011 657584233
Fax: 011 657536181

Murata Hong Kong
Room 709-712 Miramar Tower, 1
Kimberly Road, Tsimshatsui,
Kowloon, Hong Kong
Phone: 011-85223763898
Fax: 011-85223755655

Panasonic.
6550 Katella Ave
Cypress, CA 90630-5102
Phone: (714) 373-7366
Fax: (714) 373-7323

Sumida Electric Co., LTD.
5999, New Wilke Road,
Suite #110
Rolling Meadows, IL, 60008 U.S.A.
Phone: (847) 956-0666
Fax: (847) 956-0702

Sumida Electric Co., LTD.
4-8, Kanamachi 2-Chrome,
Katsushika-ku, Tokyo 125 Japan
Phone: 03-3607-5111
Fax: 03-3607-5144

Sumida Electric Co., LTD.
Block 15, 996, Bendemeer Road
#04-05 to 06, Singapore 339944
Republic of Singapore
Phone: 2963388
Fax: 2963390

Sumida Electric Co., LTD.
14 Floor, Eastern Center, 1065
King's Road, Quarry Bay,
Hong Kong
Phone: 28806688
Fax: 25659600

Polarizers/transflector Mnfg.

Nitto Denko
Yoshi Shinozuka
Bayside Business Park 48500
Fremont, CA. 94538
Phone: 510 445 5400
Fax: 510 445-5480

Top Polarizer- NPF F1205DU
Bottom - NPF F4225
or (F4205) P3 w/transflector

Transflector Material
Astra Products
Mark Bogin
P.O. Box 479
Baldwin, NJ 11510
Phone (516)-223-7500
Fax (516)-868-2371

EL Lamp Manufacturers

Leading Edge Ind. Inc.
11578 Encore Circle
Minnetonka, MN 55343
Phone 1-800-845-6992

Midori Mark Ltd.
1-5 Komagata 2-Chome
Taita-Ku 111-0043 Japan
Phone: 81-03-3848-2011

Luminescent Systems inc. (LSI)
101 Etna Road
Lebanon, NH. 03766-9004
Phone: (603) 448-3444
Fax: (603) 448-3452

NEC Corporation
Yumi Saskai
7-1, Shiba 5 Chome, Minato-ku,
Tokyo 108-01, Japan
Phone: (03) 3798-9572
Fax: (03) 3798-6134

Seiko Precision
Shuzo Abe
1-1, Taihei 4-Chome,
Sumida-ku, Tokyo, 139 Japan
Phone: (03) 5610-7089
Fax: (03) 5610-7177

Gunze Electronics
2113 Wells Branch Parkway
Austin, TX 78728
Phone: (512) 752-1299
Fax: (512) 252-1181

PACKAGE: 10-PIN MSOP PACKAGE

(ALL DIMENSIONS IN MILLIMETERS)

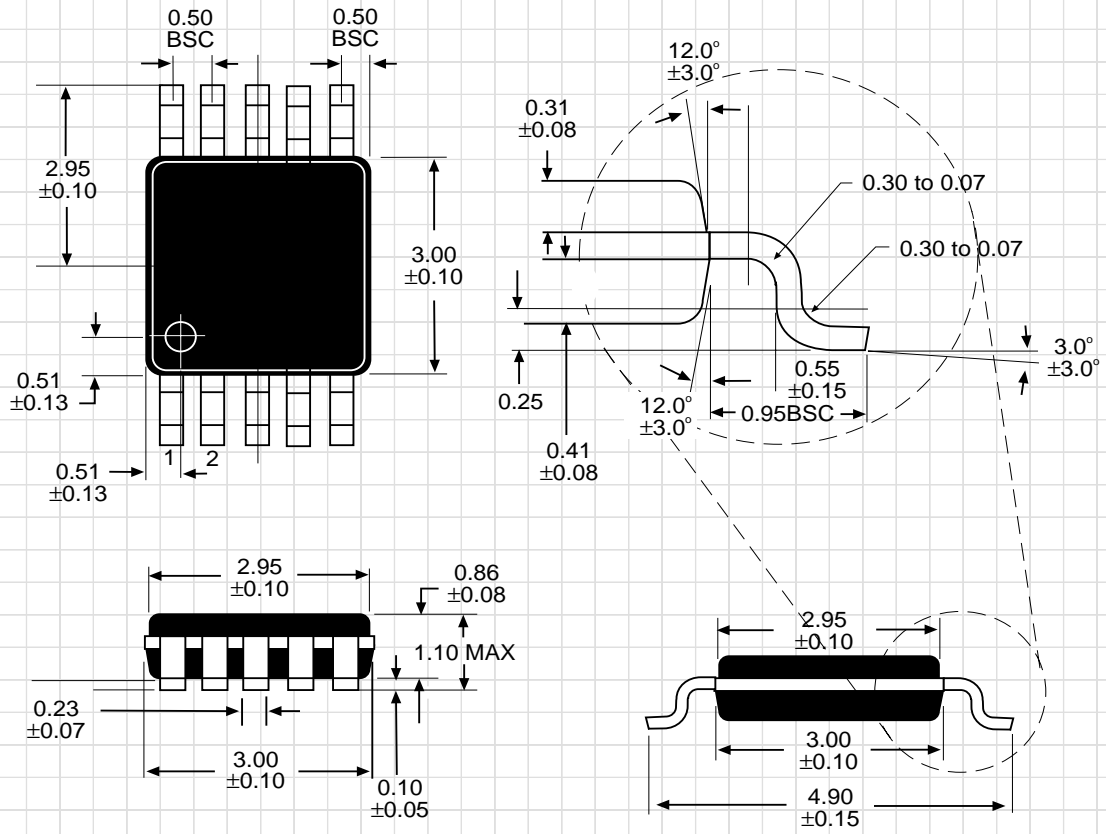

ORDERING INFORMATION

Model	Temperature Range	Package Type
SP4491EU	-40°C to +85°C	10-Pin MSOP
SP4491UEB		Evaluation Board



SIGNAL PROCESSING EXCELLENCE

Sipex Corporation

Headquarters and Sales Office

22 Linnell Circle
Billerica, MA 01821
TEL: (978) 667-8700
FAX: (978) 670-9001
e-mail: sales@sipex.com

Sales Office

233 South Hillview Drive
Milpitas, CA 95035
TEL: (408) 934-7500
FAX: (408) 935-7600

Sipex Corporation reserves the right to make changes to any products described herein. Sipex does not assume any liability arising out of the application or use of any product or circuit described herein; neither does it convey any license under its patent rights nor the rights of others.